

ADVERTIMENT. La consulta d'aquesta tesi queda condicionada a l'acceptació de les següents condicions d'ús: La difusió d'aquesta tesi per mitjà del servei TDX (www.tesisenxarxa.net) ha estat autoritzada pels titulars dels drets de propietat intel·lectual únicament per a usos privats emmarcats en activitats d'investigació i docència. No s'autoritza la seva reproducció amb finalitats de lucre ni la seva difusió i posada a disposició des d'un lloc aliè al servei TDX. No s'autoritza la presentació del seu contingut en una finestra o marc aliè a TDX (framing). Aquesta reserva de drets afecta tant al resum de presentació de la tesi com als seus continguts. En la utilització o cita de parts de la tesi és obligat indicar el nom de la persona autora.

ADVERTENCIA. La consulta de esta tesis queda condicionada a la aceptación de las siguientes condiciones de uso: La difusión de esta tesis por medio del servicio TDR (www.tesisenred.net) ha sido autorizada por los titulares de los derechos de propiedad intelectual únicamente para usos privados enmarcados en actividades de investigación y docencia. No se autoriza su reproducción con finalidades de lucro ni su difusión y puesta a disposición desde un sitio ajeno al servicio TDR. No se autoriza la presentación de su contenido en una ventana o marco ajeno a TDR (framing). Esta reserva de derechos afecta tanto al resumen de presentación de la tesis como a sus contenidos. En la utilización o cita de partes de la tesis es obligado indicar el nombre de la persona autora.

WARNING. On having consulted this thesis you're accepting the following use conditions: Spreading this thesis by the TDX (www.tesisenxarxa.net) service has been authorized by the titular of the intellectual property rights only for private uses placed in investigation and teaching activities. Reproduction with lucrative aims is not authorized neither its spreading and availability from a site foreign to the TDX service. Introducing its content in a window or frame foreign to the TDX service is not authorized (framing). This rights affect to the presentation summary of the thesis as well as to its contents. In the using or citation of parts of the thesis it's obliged to indicate the name of the author

UNIVERSITAT POLITÈCNICA DE CATALUNYA
PROGRAMA DE DOCTORAT DE MATEMÀTICA APLICADA

DEPARTAMENT DE MATEMÀTICA APLICADA I

Propagation in reaction-diffusion equations with
fractional diffusion

by
Anne-Charline Coulon

Cotutela de tesis : Université Paul Sabatier - Toulouse
Supervisors : Xavier Cabré and Jean-Michel Roquejoffre

Barcelona, July 2014

Contents

Introduction	4
Notations	19
I Periodic case and monotone systems : Asymptotic location of level sets	23
1 Propagation in periodic media	25
1.1 Introduction	25
1.2 Formal analysis	27
1.3 Effect of $(-\Delta)^\alpha$ on \tilde{u}_*	31
1.4 Construction of subsolutions and supersolutions	35
1.5 Proof of Theorem 1.1.3	37
1.6 Proof of Theorem 1.1.4	40
1.7 Numerical simulations in space dimension 2	42
2 Monotone systems	53
2.1 Introduction	53
2.2 Mild solutions	55
2.3 Comparison principles	57
2.3.1 Comparison principle for mild solutions	57
2.3.2 Comparison principle for classical solutions	58
2.4 Upper bound for the solution to (2.1.1)	60
2.5 Lower bound for the solution to (2.1.1)	66
2.6 Proof of Theorem 2.1.2	69
II The influence of a line with fractional diffusion on Fisher-KPP propagation	75
3 Existence, uniqueness, comparison principle	77
3.1 Introduction	77

3.2	General results	78
3.2.1	Trace theory	78
3.2.2	Sectorial operators	78
3.3	Study of the operator A	81
3.3.1	Location of zeroes	82
3.3.2	Closedness of A and density of its domain	84
3.3.3	A is sectorial in X	87
3.3.4	Particular case : x -independent solutions	96
3.4	Problem (3.1.1) : existence, regularity, comparison principle	96
3.4.1	Existence and regularity of the solution to (3.1.1)	96
3.4.2	Comparison principle	102
4	Long time behaviour	109
4.1	Introduction	109
4.2	Construction of a subsolution	111
4.2.1	An auxiliary 1D subsolution	111
4.2.2	Bounding from below the solution at time 2	114
4.2.3	Proof of Theorem 4.1.2 - Part 1	117
4.3	Construction of a supersolution	123
4.3.1	Preliminary result : estimate of an integral	125
4.3.2	Proof of Theorem 4.3.1	129
4.3.3	Proof of Theorem 4.1.2 - Part 2	139
4.4	Propagation in the field : proof of Theorem 4.1.3	140
5	Numerical simulations	145
5.1	Introduction	145
5.2	Numerical procedure	145
5.3	Standard diffusion on the road ($\alpha = 1$) : level sets in the field	148
5.4	Fractional diffusion on the road : level sets in the field	152
5.5	Numerical determination of the asymptotic location of the level sets, on the road, in the fractional case	154
	Conclusion and Perspectives	160

Introduction

In this thesis, we want to understand the long time behaviour, and more precisely if slow or fast propagation hold, of solutions to reaction-diffusion problems with long range integral diffusion. To describe the general idea, let us consider the equation

$$\partial_t u(x, t) + Au(x, t) = f(x, u(x, t)), \quad x \in \mathbb{R}^d, t > 0, \quad (0.0.1)$$

where A is an elliptic operator describing some diffusive process and f is a source term. The simplest examples of functions f will be $f(x, u) = f(u) = u - u^2$, or $f(x, u) = \mu(x)u - u^2$, with μ a positive function periodic in each x_i variable. These examples will be taken as references throughout this introduction. Such reaction terms are called nonlinearities of Fisher-KPP type, in reference to Fisher ([45]) and Kolmogorov, Petrovskii and Piskunov ([61]), where these models are introduced for the first time. We will come back to this later.

Set, to fix ideas, $f(x, u) = u - u^2$ in (0.0.1). Two terms are in competition in this model, and intuitively :

- the reaction, given by the ordinary differential equation $\frac{du}{dt} = u - u^2$, will make u to grow to the stable state 1,
- the diffusion, given by the operator A , will spread the support of u .

In fact, it is well known, see [6] and [16], that, starting from any nonnegative and compactly supported function, the solution to (0.0.1) with $f(x, u) = u - u^2$ tends to the stable state 1 as t tends to infinity, on every compact set. Thus, a transition zone appears between the unstable state 0 and the stable state 1 and we may expect it to grow as time goes to infinity.

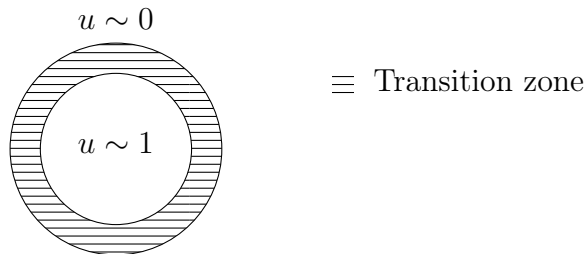

Expected picture for $f(x, u) = u - u^2$ in (0.0.1).

This raises the following question : What is the growth of the interface that separates the area where u is close to 1 from the one where u is close to 0, as time goes to infinity?

In this thesis, we wish to answer this question when the operator A has the features of the fractional Laplacian, and to compare to what happens when A is the standard Laplacian. We will see that the fractional operator has specific properties that lead to an exponential in time propagation of the solution to (0.0.1). Our goal is to compute this speed of propagation as precisely as possible in various examples. Rigorously, this means that, if u is the solution to (0.0.1), starting from a nonnegative, compactly supported and non identically equal to 0 initial condition, we look for a function $R_e(t)$ going to infinity as t tends to infinity such that, for every direction given by a unit vector $e \in \mathbb{R}^d$ and every constant $c \in (0, 1)$,

$$\liminf_{t \rightarrow +\infty} \inf_{\substack{x=\rho e, \\ 0 \leq \rho \leq R_e(ct)}} u(x, t) > 0 \quad \text{and} \quad \limsup_{t \rightarrow +\infty} \sup_{\substack{x=\rho e, \\ \rho \geq R_e(c^{-1}t)}} u(x, t) = 0. \quad (0.0.2)$$

We will adopt this slightly unusual definition to cover both standard and fractional diffusions.

Reaction-diffusion equations of the form (0.0.1) arise in various fields like chemistry, biology or ecology. In population dynamics, when we want to study spatial propagation or spreading of biological species (muskrats in [81], wolves in [72] or sharks in [55] for instance), the quantity $u(x, t)$ in (0.0.1) stands for the density of the population at position x and time t (see [81] for instance). The reaction term f corresponds to the growth rate of the population and represents interactions between the individuals and the medium. It depends on the density of the population and on the location of the population through the space variable x . The diffusive operator A describes the motion of the individuals. Let us mention that, especially in the modelling of biological invasions, a description alternative to PDE is by integral models.

This introduction is organised as follows. We first present, in more detail, known results on reaction-diffusion equations of Fisher-KPP type, in homogeneous and periodic media. As we will see, the starting point is the question of making more precise a certain expansion rate in the fractional homogeneous case, which will lead us unexpectedly far. Indeed, it will enable us to set up a new method to construct explicit subsolutions and supersolutions to this type of equations, which will enable us to treat the periodic case (a problem that was previously open) as well as monotone systems involving fractional diffusion. A large part of the thesis is devoted to a new model dealing with the influence of a line, with fractional diffusion, on Fisher-KPP propagation.

A. Front propagation in Fisher-KPP type models : an overview

A.1. Homogeneous media

The simplest and well studied model was first described by Fisher and Kolmogorov, Petrovskii and Piskunov in [45, 61] and corresponds to the case when $A = -\Delta$, and f , of Fisher-KPP type, does not depend on x . We refer to this as a homogeneous medium. Such a function is supposed to be concave and to have two zeroes : an unstable one at $u = 0$, and a stable one at, let us say, $u = 1$. The typical example is $f(u) = u - u^2$.

Equation (0.0.1) has a family of planar travelling fronts, that are solutions of the form $u(x, t) = U(x \cdot e - ct)$, where e is a unit fixed vector representing the direction of propagation and $c > 0$ is the speed of the front. The function U satisfies

$$-U'' - cU' = f(U), \quad U(-\infty) = 1, \quad U(+\infty) = 0.$$

In [61], it is proved that there is a threshold $c^* = 2\sqrt{f'(0)}$ for the speed c , namely, the constant c^* is the smallest possible speed c for a planar travelling front to exist. In a more general setting, Aronson and Weinberger proved, in [6], that any non identically equal to 0, nonnegative and compactly supported initial condition invades the unstable state in the following sense :

$$\text{for all } c < c^*, \lim_{t \rightarrow +\infty} \inf_{|x| \leq ct} u(x, t) = 1, \text{ and for all } c > c^*, \lim_{t \rightarrow +\infty} \inf_{|x| \geq ct} u(x, t) = 0.$$

This means that, in this case, the position of the front depends linearly on time and that we can take $R_e(t) = c^*t + o(t)$ in (0.0.2). A very general notion of propagation velocity was introduced in [13] to study propagation in general unbounded domains of \mathbb{R}^d . In the case of globally front like initial data, decaying slower than any exponential, Hamel and Roques proved in [51] that superlinear speeds of propagation arise.

Another way of understanding front propagation, due to Evans and Souganidis in [44] for $A = -\Delta$, is through a singular perturbation setting. Given that a linear in time invasion is expected, it is natural to look at the solution at large scale in t and x , namely to set for $\varepsilon > 0$:

$$u_\varepsilon(x, t) = u\left(\frac{x}{\varepsilon}, \frac{t}{\varepsilon}\right).$$

The equation solved by u_ε is

$$\partial_t u_\varepsilon - \varepsilon \Delta u_\varepsilon = \frac{1}{\varepsilon}(u_\varepsilon - u_\varepsilon^2).$$

One easily sees, at least in a formal way, that u_ε converges to 0 or 1, according to the value of $u_\varepsilon - u_\varepsilon^2$. The limiting transition zone is a surface evolving according to

the eikonal equation $v_n = 2$, where v_n is the normal speed to the front. This approach is also used in simple combustion models, see [8]. A general geometric approach is described in [9].

The use of a local operator, such as the standard Laplacian, corresponds to individuals moving under a Brownian process. Numerous works, mainly in physics, have shown that this approach is not correct anymore when considering species that have jumps of non infinitesimal lengths (see [36, 55] for instance). This particular motion of the individuals leads to integro-differential equations, with heavy or non exponentially bounded tails, implying infinite speeds of propagation.

In this thesis, we focus on anomalous diffusion processes, given by stable Lévy processes, whose infinitesimal generators are the fractional Laplacians. Let us mention here that nonlinear equations with fractional diffusion are being intensively studied. For the main definitions, we refer to [64].

Reaction-diffusion equations are not the only field where nonlocal diffusion is involved, let us cite some important instances dealing with nonlocal operators :

- Nonlocal geometric front propagation : Caffarelli and Souganidis in [34] and Imbert, Monneau and Rouy in [56],
- Nonlocal free boundary problems : Caffarelli, Roquejoffre and Sire in [32],
- Nonlocal minimal surfaces : Caffarelli, Roquejoffre and Savin in [31] and Dávila, del Pino and Wei in [39],
- Fully nonlinear elliptic and parabolic equations : Cabré and Sire in [27, 28], Cabré and Solà-Morales in [29], Caffarelli, Chan and Vasseur in [30], Caffarelli and Silvestre in [33] and Frank and Lenzmann in [46],
- Hyperbolic equations : Alibaud, Droniou and Vovelle in [3], Kiselev, Nazarov and Shterenberg in [59],
- Quasi geostrophic equations : Caffarelli and Vasseur in [35], Kiselev, Nazarov and Volberg in [60] and Constantin and Vicol in [37].

Let us now recall the definition of the fractional Laplacian. For any function h that decays sufficiently fast, the fractional power of the Laplacian is defined for $\alpha \in (0, 1)$ by

$$(-\Delta)^\alpha h(x) = c_{d,\alpha} \text{p.v.} \left(\int_{\mathbb{R}^d} \frac{h(x) - h(y)}{|x - y|^{d+2\alpha}} dy \right),$$

where p.v. stands for the Cauchy principal value, and

$$c_{d,\alpha} = \frac{\alpha \Gamma(\frac{d}{2} + \alpha)}{\pi^{2\alpha + \frac{d}{2}} \Gamma(1 - \alpha)}.$$

This constant is in fact adjusted so that this operator is a pseudo-differential operator with symbol $|\xi|^{2\alpha}$. These definitions are consistent with the standard Laplace operator when $\alpha = 1$.

The main difference between the standard Laplacian and the fractional Laplacian (besides locality versus nonlocality) is the fundamental solution, that is to say the solution to $\partial_t p_\alpha + (-\Delta)^\alpha p_\alpha = 0$ with Dirac mass at $t = 0$. The function p_α decays in a Gaussian fashion for the first operator, whereas it has an algebraic decay for the latter. Indeed, for the fractional Laplacian, there exists a constant $B > 1$ such that, for $(x, t) \in \mathbb{R}^d \times \mathbb{R}_+$

$$\frac{B^{-1}t}{t^{\frac{d}{2\alpha}+1} + |x|^{d+2\alpha}} \leq p_\alpha(x, t) \leq \frac{Bt}{t^{\frac{d}{2\alpha}+1} + |x|^{d+2\alpha}}. \quad (0.0.3)$$

This feature will be crucial when analysing the long time behaviour of the solution to (0.0.1). Indeed, considering the homogeneous medium ($f(u) = u - u^2$, and $A = (-\Delta)^\alpha$ in problem (0.0.1)), the propagation is exponential in time. Although this fact was well noted in physics references (see [71] for instance), the first mathematically rigorous result is due to Cabré and Roquejoffre in [25] and [26]. They prove the existence of the exponent $c_\star := \frac{1}{d+2\alpha}$ such that the solution to (0.0.1) starting from, for instance, a nonnegative, piecewise continuous, compactly supported and non indentially equal to 0 initial condition, satisfies

$$\text{for all } c < c_\star, \lim_{t \rightarrow +\infty} \inf_{|x| \leq e^{ct}} u(x, t) = 1, \quad \text{and for all } c > c_\star, \lim_{t \rightarrow +\infty} \inf_{|x| \geq e^{ct}} u(x, t) = 0.$$

For equations with smooth dispersal kernels, the long time behaviour is studied by Garnier in [47].

These results are in complete contrast with the linear propagation in time obtained in the case $A = -\Delta$. We mention here that the transition between linear propagation ($\alpha = 1$) and exponential propagation ($\alpha \in (0, 1)$) has been examined by Roquejoffre and the author of the thesis in [38].

A.2. Periodic media

The motivation we have in mind is ecological modelling or biological invasions, where heterogeneities play an essential role. Indeed, habitats, like forests or plains, are often fragmented by natural or artificial barriers, like rivers or roads. It raises the question of the impact of such an heterogeneity on the spreading of species. For more details, see [14] and its references. In this line, the particular model that we describe here is a general heterogeneous periodic problem, first introduced by Shigesada, Kawasaki and Teramoto in [78], extending the homogeneous case (0.0.7).

On the mathematical side, for $i \in \llbracket 1, d \rrbracket$, let ℓ_i be a given positive number. In the following, let us say that a function $g : \mathbb{R}^d \rightarrow \mathbb{R}$ is periodic in each x_i -variable if

$$g(x_1, \dots, x_k + \ell_k, \dots, x_d) \equiv g(x_1, \dots, x_d), \quad \text{for all } k \in \llbracket 1, d \rrbracket.$$

We denote by \mathcal{C}_ℓ the period cell defined by

$$\mathcal{C}_\ell = (0, \ell_1) \times \cdots \times (0, \ell_d).$$

Reaction-diffusion equations in periodic media, which means for us problem (0.0.1) when $f(x, s)$ is of Fisher-KPP type and \mathcal{C}_ℓ periodic in the x variables, have a biological interpretation, given in [14] for $A = -\Delta$ and in [16] for $A = (-\Delta)^\alpha$. In this introduction, we only consider the typical example $f(x, s) = \mu(x)s - s^2$, where μ is \mathcal{C}_ℓ periodic. Regions of space where μ is positive represent favourable zones for the population, whereas regions where μ is negative prevent the species from developing. We focus on the particular problem

$$\begin{cases} \partial_t u + (-\Delta)^\alpha u = \mu(x)u - u^2, & x \in \mathbb{R}^d, t > 0, \\ u(x, 0) = u_0(x), & x \in \mathbb{R}^d, \end{cases} \quad (0.0.4)$$

where $\alpha \in (0, 1]$ and the initial condition u_0 is nonnegative, piecewise continuous, non identically equal to 0 and compactly supported.

In both cases $\alpha = 1$ and $\alpha \in (0, 1)$, it is well known that, under assumptions explained below, the solution to (0.0.4) will tend, as t goes to infinity, to a stable state (i.e. a steady solution u_+ to (0.0.4) which is stable). In other words, any initial population invades the unstable state, which corresponds to the unstable solution $u = 0$. In population dynamics, this corresponds to the survival of the species. To estimate at which speed the invasion takes place means to find the function $R_e(t)$ defined in (0.0.2) (here the speed could depend on the direction e of propagation).

Mathematically speaking, the long time behaviour of the solution to (0.0.4) is encoded in λ_1 , the principal periodic eigenvalue of the operator $(-\Delta)^\alpha - \mu(x)I$. Indeed, if $\lambda_1 \geq 0$, then every solution to (0.0.4) starting from a bounded nonnegative initial condition tends to 0 as t goes to infinity. This case is not the interesting one since it corresponds to the extinction of the population. If $\lambda_1 < 0$, then the solution to (0.0.4) starting from a bounded nonnegative initial condition tends, as t goes to infinity, to the unique bounded positive steady solution, denoted by u_+ (periodic by uniqueness), on every compact set. The result is due to Berestycki, Hamel and Roques in [14] for $\alpha = 1$, and Berestycki, Roquejoffre and Rossi in [16] for $\alpha \in (0, 1)$. In this result, the convergence only holds on every compact set and, therefore, it does not enable us to understand the transition between the stable state u_+ and the unstable state 0. To answer this question about the position of the invasion front, we distinguish $\alpha = 1$ and $\alpha \in (0, 1)$.

The case $\alpha = 1$ is well studied and the limiting interface is shown to satisfy the Freidlin-Gärtner propagation law. Indeed, from Freidlin and Gärtner in [49], we may take

$$R_e(t) = w^*(e)t, \quad w^*(e) = \min_{e' \in S^{d-1}, e' \cdot e > 0} \frac{c^*(e')}{e' \cdot e},$$

where $c^*(e')$ is the minimal speed of plane waves in the direction e' . A plane wave in a direction $e \in S^{d-1}$ of the space, is a solution to $\partial_t u - \Delta u = \mu(x)u$ of the form

$e^{-\lambda(x \cdot e - ct)}\phi(x)$, where ϕ is periodic in each x_i -variable, $\lambda > 0$ and $c > 0$ to be chosen so that such solutions exist. Their proof, using probabilistic tools, is quite efficient for second order reaction-diffusion equation and is, by no means, limited to Fisher-KPP type reaction terms. Proofs using PDE arguments or dynamical systems are given in [11], [12], [43], [76], [83].

The case $\alpha \in (0, 1)$ is the main issue of this thesis and we focus on it from now on. In the sequel, we first describe the known results, which motivates the introduction of a new method that will be subsequently discussed.

A.3. Asymptotic speed of propagation given by the fundamental solution

We first focus on the homogeneous case, when $\mu \equiv 1$ in (0.0.4). Indeed, even in this case no sharp asymptotic expression of $R_e(t)$ was known, except for the case $d = 1$ and $\alpha = \frac{1}{2}$, that was settled in [26]. Recall that, in the fractional homogeneous case, to guarantee the limits in (0.0.2), the authors of [26] needed to take $|x| \leq C e^{\sigma_1 t}$ (respectively $|x| \geq C e^{\sigma_2 t}$) with $\sigma_1 < \frac{1}{d+2\alpha} < \sigma_2$. This does not give a sharp asymptotic expression of the speed of propagation $R_e(t)$ defined in (0.0.2), in the sense that it allows any subexponential perturbation of its expression.

A first guess to find $R_e(t)$ in the homogeneous case is to use the fact that the Fisher-KPP nonlinearity is concave. In our case, this simply means that $f(u) \leq u$. Thus, we can compare the solution to (0.0.4), with $\mu \equiv 1$, to the solution to the linearised problem at 0.

In the particular case $\alpha = 1$, this idea leads to a simple proof that the speed of propagation is at most 2. Indeed, the heat kernel of (0.0.4), with $\alpha = 1$, is well known and, consequently, solving the linear equation $\partial_t \bar{u} - \Delta \bar{u} = \bar{u}$, we have

$$u(x, t) \leq \bar{u}(x, t) = e^t \int_{\mathbb{R}^d} \frac{e^{-\frac{|x-y|^2}{4t}}}{(4\pi t)^{d/2}} u_0(y) dy \leq C t^{-d/2} e^{t - \frac{|x|^2}{4t}}. \quad (0.0.5)$$

This proves that for all $w > 2$,

$$\lim_{t \rightarrow +\infty} \sup_{|x| \geq wt} u(x, t) = 0.$$

Even in the case $\alpha = 1$, this bound does not give the precise asymptotic expression of the location the level sets. This is due to the presence of the factor $t^{-d/2} = t^{-1/2}$. Indeed, for $\alpha = 1$, $\mu \equiv 1$ and $d = 1$ in (0.0.4), one may choose, for any unit vector $e \in \mathbb{R}^d$:

$$R_e(t) = 2t - \frac{3}{2} \log(t) + \underset{t \rightarrow +\infty}{\mathbf{O}}(1).$$

The original proof of this equality is due to Bramson in [22], using probabilistic tools. The following extension to higher dimensions is proved by Gärtner in [48]:

$$R_e(t) = 2t - \frac{d+2}{2} \log(t) + \underset{t \rightarrow +\infty}{\mathbf{O}}(1).$$

In [50], another proof using PDE arguments is given.

If we look at what happens in the fractional case, using once again that $f(u) \leq u$ and using the decay of p_α recalled in (0.0.3), we have :

$$u(x, t) \leq \frac{Cte^t}{t^{\frac{d}{2\alpha}+1} + |x|^{d+2\alpha}}.$$

This implies

$$\left\{ x \in \mathbb{R}^d \mid u(x, t) = \frac{1}{2} \right\} \subset \left\{ |x| \leq t^{\frac{1}{d+2\alpha}} e^{\frac{t}{d+2\alpha}} \right\}. \quad (0.0.6)$$

Hence, one could first think that the position of the front behaves like $t^{\frac{1}{d+2\alpha}} e^{\frac{t}{d+2\alpha}}$, which is not in contradiction with the exponential in time propagation proved in [26]. However, in the case $\alpha = 1$, the solution goes slower than the solution to the linearised problem at 0, so one could wonder if the factor $t^{\frac{1}{d+2\alpha}}$ is essential in the asymptotic expression of the speed of propagation. In [26], it is proved that, for any $e \in S^{d-1}$, $R_e(t) = e^{\frac{t}{d+2\alpha}}$ whenever $d = 1$ and $\alpha = \frac{1}{2}$. In fact, in this particular case, we have an explicit expression of the heat kernel $p_{\frac{1}{2}}$ and the authors are able to construct explicit subsolutions and supersolutions to (0.0.4), with $\mu \equiv 1$. Consequently, the factor $t^{\frac{1}{d+2\alpha}} = t^{\frac{1}{2}}$ is not present in this case and the solution goes also slower than the solution to the linearised problem at 0. Is it the same for any dimension $d \geq 1$ and any $\alpha \in (0, 1)$? This is the starting point of the thesis.

B. Presentation of the results

B.1. A new method to study the speed of propagation in reaction-diffusion problems with fractional diffusion

To have an asymptotic expression of $R_e(t)$, defined in (0.0.2), up to $O(1)$ error, it is sufficient to construct explicit subsolutions and supersolutions, close enough to the solution. The following argument, which is specific to fractional diffusion, seems to be new.

Let us explain its principle on the homogeneous problem :

$$\begin{cases} \partial_t u + (-\Delta)^\alpha u = u - u^2, & x \in \mathbb{R}^d, t > 0, \\ u(x, 0) = u_0(x), & x \in \mathbb{R}^d, \end{cases} \quad (0.0.7)$$

for $\alpha \in (0, 1)$ and u_0 compactly supported, non identically equal to 0.

As said before, the speed of propagation of the solution u to (0.0.7) is expected to be smaller than $t^{\frac{1}{d+2\alpha}} e^{-\frac{t}{d+2\alpha}}$ for large times. Thus, the idea is to define a correctly rescaled version of the solution u by

$$v(y, t) = u(yr(t), t), \quad \text{for } y \in \mathbb{R}^d \text{ and } t \geq 0,$$

where $r(t)$ is a positive function, chosen so that the function v remains bounded away from the two steady solutions 0 and 1 on compact sets. From what has been presented before, we already know that for all $c > \frac{1}{1+2\alpha}$, $r(t)e^{-ct}$ should tend to 0 as time t goes to infinity.

The function v solves, for $y \in \mathbb{R}^d$ and $t > 0$,

$$\partial_t v - \frac{r'(t)}{r(t)} y \partial_y v + r(t)^{-2\alpha} (-\Delta)^\alpha v = v - v^2.$$

Formally, we neglect the term $r(t)^{-2\alpha} (-\Delta)^\alpha v$, that should tend to 0 as time goes to infinity since $r(t)$ behaves as an exponential with positive exponent. We are led to the following transport equation, for $y \in \mathbb{R}^d$ and $t > 0$:

$$\partial_t \tilde{v} - \frac{r'(t)}{r(t)} y \partial_y \tilde{v} = \tilde{v} - \tilde{v}^2, \quad (0.0.8)$$

where \tilde{v} should approximate v well. If \tilde{v}_0 denotes the initial condition of \tilde{v} , then we have, for $y \in \mathbb{R}^d$ and $t > 0$:

$$\tilde{v}(y, t) = \frac{\tilde{v}_0(yr(t))}{\tilde{v}_0(yr(t)) + (1 - \tilde{v}_0(yr(t)))e^{-t}}.$$

It remains to choose \tilde{v}_0 . From its construction, \tilde{v}_0 is supposed to approximate u_0 . If we make the naive choice $\tilde{v}_0 = u_0$, where u_0 is compactly supported, the function \tilde{v} will be compactly supported at any time, which is not our aim. Indeed, recall that we want the approximation \tilde{v} to remain bounded away from the two steady solutions 0 and 1 on compact sets. Therefore, it seems natural to take into account that, as proved in [26], for all $t > 0$, $x \mapsto |x|^{d+2\alpha} u(x, t)$ is uniformly bounded in x . Thus, we specialise

$$\tilde{v}_0(y) = \frac{1}{1 + |y|^{d+2\alpha}},$$

which implies

$$\tilde{v}(y, t) = \frac{1}{1 + |y|^{d+2\alpha} r(t)^{d+2\alpha} e^{-t}}.$$

Keeping in mind that v and \tilde{v} are expected to be bounded away from 0 and 1, the term $r(t)^{d+2\alpha} e^{-t}$ has to be constant in time. This leads to the choice

$$r(t) = e^{\frac{t}{d+2\alpha}},$$

which is compatible with the assumption on r we have made above. Consequently, \tilde{v} can be seen as the stationary solution v_∞ to (0.0.8) starting from \tilde{v}_0 .

From this formal analysis, going back to the main variable x , the idea is to consider the following family of functions, modelled by \tilde{v} :

$$\tilde{u}(x, t) = \frac{a}{1 + b(t) |x|^{d+2\alpha}},$$

and to adjust the constant $a > 0$, and the function $b(t)$ asymptotically proportional to $r(t) = e^{\frac{t}{d+2\alpha}}$, so that \tilde{u} serves as a subsolution or a supersolution to (0.0.7). Let us notice that \tilde{u} is exactly equal to $av_\infty(b(t)x)$, where v_∞ is the stationary solution to (0.0.8) starting from \tilde{v}_0 .

Once we have constructed an explicit subsolution \underline{u} and supersolution \bar{u} to the main problem (0.0.7), we need to find a time $t_0 > 0$ such that, for all $x \in \mathbb{R}^d$, we have

$$\underline{u}(x, 0) \leq u(x, t_0) \leq \bar{u}(x, 0).$$

Finally, the comparison principle leads to the fact that we may choose $R_e(t) = e^{\frac{t}{d+2\alpha}}$ in (0.0.2) for the homogeneous problem (0.0.7). Consequently we will establish that the coefficient $t^{\frac{1}{d+2\alpha}}$ in (0.0.6), that appeared in the speed of propagation of the solution to the linearised problem at 0, does not appear in the correct front position, for all $\alpha \in (0, 1)$ and in all dimensions $d \geq 1$.

To summarise,

Step 1 : We prove - at least when it is not available - the existence and uniqueness of the solution and a comparison principle for classical solutions.

Step 2 : By a formal analysis, we rescale the problem in the space variable, let us say doing the change $x = yr(t)$, where $r(t)$ is the expected speed of propagation. Then, we neglect the diffusive terms, that should tend to 0 as time goes to infinity, to get a transport equation.

Step 3 : We estimate the solution at a positive time t_0 . This step not only gives us an initial condition for the transport equation obtained in Step 2, but also makes it possible to put the subsolution (respectively, supersolution) that we construct under (respectively, above) the solution at time t_0 .

Step 4 : The solution to the transport equation obtained in Step 2, completed with an initial condition that decays like the solution at time t_0 (found in Step 3), enables us to construct a family of subsolutions and supersolutions, depending on a constant $a > 0$ and a function $b(t)$ asymptotically proportional to the speed of propagation.

Remark : If purely exponential in time propagation is expected, then the coefficient $\frac{r'(t)}{r(t)}$ in the transport equation (0.0.8) is constant. In this case, the family of candidates for being subsolutions or supersolutions to the problem under study, can be modelled by the stationary solution v_∞ to the rescaled transport equation obtained in Step 2. Indeed, this family can be chosen of the form $av_\infty(b(t)x)$.

B.2. Results

Periodic media

With this method at hand, we are in position to treat periodic media, which was initially the main issue of the thesis.

Under assumptions on f , that we do not detail in this introduction, we prove that the solution to (0.0.4) spreads exponentially fast in time as soon as the principal eigenvalue λ_1 of the operator $(-\Delta)^\alpha - \mu(x)I$ satisfies $\lambda_1 < 0$. In fact, we prove that (0.0.2) holds with $R_e(t) = e^{\frac{|\lambda_1|}{d+2\alpha}t}$. This proves that spreading does not depend on the direction of propagation, and this is in contrast with the Freidlin-Gärtner formula, for the standard Laplacian. Moreover, the estimate that we obtain is much sharper than that in [25], [26] for the homogeneous model.

We also prove the convergence to the steady state in sets that spread exponentially fast in time. Finally, we carry out numerical simulations to investigate the dependence of the speed of propagation on the initial condition. We show that a symmetrisation, in the sense of Jones in [57], seems to occur, if the initial condition decays fast enough at infinity.

Monotone systems

The work on the single equation (0.0.7), in homogeneous media, can be extended to reaction-diffusion systems. Let us give here the main bibliographical references. The first definitions of spreading speeds for cooperative systems in population ecology and epidemic theory are due to Lui in [68, 69]. In a series of papers, Lewis, Li and Weinberger [65, 66, 67] studied spreading speeds and travelling waves for a particular class of cooperative reaction-diffusion systems, with standard diffusion. Results on single equations in the singular perturbation framework proved by Evans and Souganidis in [44] have also been extended by Barles, Evans and Souganidis in [7]. The viscosity solutions framework is studied in [23], with a precise study of the Harnack inequality. In these papers, the system under study is of the following form

$$\partial_t u_i - d_i \Delta u_i = f_i(u), \quad x \in \mathbb{R}^d, t > 0,$$

where, for $m \in \mathbb{N}^*$, $u = (u_i)_{i=1}^m$ is the unknown.

For all $i \in \llbracket 1, m \rrbracket$, the constants d_i are assumed to be positive as well as the bounded, smooth and Lipschitz initial conditions, defined from \mathbb{R}^d to \mathbb{R}_+ . The essential assumptions concern the reaction term $F = (f_i)_{i=1}^m$. This term is assumed to be smooth, to have only two zeroes 0 and $a \in \mathbb{R}^m$ in $[0, a]$, and for all $i \in \llbracket 1, m \rrbracket$, each f_i is nondecreasing in all its components, with the possible exception of the i th one. The last assumption means that the system is cooperative. Under additional hypotheses, which imply that the point 0 is unstable, the limiting behaviour of the solution $u = (u_i)_{i=1}^m$ is understood.

Our aim is to study similar systems, keeping the same assumptions on f , but considering that at least one diffusive term is given by a fractional Laplacian. This problem turns out to be a computational adaptation of what has been done for single equations. More precisely, we focus on the large time behaviour of the solution $u = (u_i)_{i=1}^m$, for $m \in \mathbb{N}^*$, to the fractional reaction-diffusion system :

$$\begin{cases} \partial_t u_i + (-\Delta)^{\alpha_i} u_i = f_i(u), & x \in \mathbb{R}^d, t > 0, \\ u_i(x, 0) = u_{0i}(x), & x \in \mathbb{R}^d, \end{cases} \quad (0.0.9)$$

where

$$\alpha_i \in (0, 1] \quad \text{and} \quad \alpha := \min_{\llbracket 1, m \rrbracket} \alpha_i < 1.$$

As general assumptions, we impose, for all $i \in \llbracket 1, m \rrbracket$, the initial condition u_{0i} to be nonnegative, non identically equal to 0, continuous and to satisfy

$$u_{0i}(x) = O(|x|^{-(d+2\alpha_i)}) \quad \text{as} \quad |x| \rightarrow +\infty.$$

We also assume that for all $i \in \llbracket 1, m \rrbracket$, the function f_i satisfies $f_i(0) = 0$ and that system (2.1.1) is cooperative, which means :

$$f_i \in C^1(\mathbb{R}^m) \quad \text{and} \quad \partial_j f_i > 0, \quad \text{on} \quad \mathbb{R}^m, \quad \text{for} \quad j \in \llbracket 1, m \rrbracket, \quad j \neq i. \quad (0.0.10)$$

We will make additional assumptions on the reaction term $F = (f_i)_{i=1}^m$ that are not general but enable us to apply the method on a class of monotone systems.

We follow Step 1 of the method defined in section B.1. and prove the existence and uniqueness of the solution, using mild solutions as done in [26]. From this, we can prove comparison principles for mild solutions and classical solutions. The last one is obtained for a class of solutions whose decay at infinity is smaller than $|x|^{-(d+2\alpha)}$, with $\alpha = \min_{i \in \llbracket 1, m \rrbracket} \alpha_i$. There is here, by the way, a slightly nontrivial issue in the computation of the fundamental solution. Steps 2 to 4 of the method described in section B.1. are carried out with only computational charges. This gives that the speed of propagation is exponential in time, with a precise exponent depending on the smallest index $\alpha = \min_{i \in \llbracket 1, m \rrbracket} \alpha_i$ and of the principal eigenvalue of the matrix $DF(0)$.

The influence of a line with fast diffusion on Fisher-KPP propagation

In the second part of the thesis, we want to apply the method, set up before, to treat the long time behaviour of the solution to a new model, introduced by Berestycki, Roquejoffre and Rossi in [18], where we include fractional diffusion.

This model deals with biological invasions directed by a heterogeneity. It is based on the fact that fast diffusion on roads can have a driving effect on the spread of epidemics (see [79] for instance). The model proposed deals with a single species in a two-dimensional environment where reproduction and usual diffusion occur except on a line of the plane, on which standard diffusion (with a different diffusion coefficient)

takes place. More precisely, we consider the half plane $\mathbb{R} \times \mathbb{R}_+$, which will be called, for the sake of simplicity, "the field", and the line $\{(x, 0), x \in \mathbb{R}\}$, "the road". Let v be the density of the population in the field, and let u be the density on the road. To take into account the exchanges of populations between the road and the field, one considers that

- a proportion $v(x, 0, t)$ of individuals from the field joins the road,
- a proportion $\mu u(x, t)$ of individuals on the road goes into the field.

It is assumed that usual diffusion and reproduction, modelled by a Fisher-KPP type nonlinearity, only occur in the field. The diffusion coefficient in the field is represented by d and on the road by D . The authors are especially concerned with fast diffusion on the line, which means D much larger than d . The system is the following :

$$\begin{cases} \partial_t v - d\Delta v = f(v), & x \in \mathbb{R}, y > 0, t > 0, \\ \partial_t u - D\partial_{xx}u = -\mu u + v|_{y=0}, & x \in \mathbb{R}, y = 0, t > 0, \\ -\partial_y v|_{y=0} = \mu u - v|_{y=0}, & x \in \mathbb{R}, y = 0, t > 0, \end{cases} \quad (0.0.11)$$

for $\mu > 0$, completed with initial conditions $v(\cdot, \cdot, 0) = v_0$ and $u(\cdot, 0) = u_0$, assumed to be nonnegative, continuous, bounded and compactly supported.

If the road is not present, recall that the invasion speed is the usual KPP velocity $c_{KPP} = 2\sqrt{df'(0)}$. In (0.0.11), there is a unique positive stationary state, which does not depend on x and y . Moreover, there is invasion of the population in the whole environment. On the road, the asymptotic speed of propagation c_* satisfies

$$c_* > c_{KPP} \quad \text{if } D > 2d \quad \text{and} \quad c_* = c_{KPP} \quad \text{if } 0 < D \leq 2d.$$

The effect of the road on the speed of propagation in other directions than on the line is elucidated in [19]. In this paper, the authors describe the asymptotic shape of the level sets of the density in the field. An extension of the model, adding a transport term and a source term on the road is studied in [17].

Our aim is to understand what happens to (0.0.11) when the fast diffusion on the line is given by a fractional Laplacian. This new model, that couples two densities, is more complex than periodic media and monotone systems, presented in the previous sections. Our method applies, but also shows its limits.

We consider the system

$$\begin{cases} \partial_t v - \Delta v = f(v), & x \in \mathbb{R}, y > 0, t > 0, \\ \partial_t u + (-\partial_{xx})^\alpha u = -\mu u + v|_{y=0} - ku, & x \in \mathbb{R}, y = 0, t > 0, \\ -\partial_y v|_{y=0} = \mu u - v|_{y=0}, & x \in \mathbb{R}, y = 0, t > 0, \end{cases} \quad (0.0.12)$$

for $\mu > 0$ and $k \geq 0$, completed with continuous, bounded and compactly supported initial conditions. The reaction term f is still of Fisher-KPP type. We have allowed here some mortality on the road, modelled by the coefficient k .

For this problem, all the steps described in the method have to be carried out. Step 1, that concerns the existence and uniqueness of the solution and a principle comparison for classical solutions, is done using the theory of sectorial operators. This framework is motivated by an integral expression of the solution, given by the Laplace transform, as explained below. We will also prove the regularity of the solution to (0.0.12). This choice of framework is not the only possible one, we could have used the viscosity solution framework to recover existence, uniqueness and regularity of the solutions to (0.0.12). See for instance Alibaud and Imbert [4]. Steps 2 to 4 of the method, that lead to the construction of two explicit functions, below and above the solution to (0.0.12) at any time, are used to study the propagation of the density u on the road. Contrary to the case of periodic media, or monotone systems, we can not explicitly solve the transport equation, that appears in Step 2 of the method, in the whole half plane. We do not even know if a global solution exists.

To circumvent the difficulty, we find a subsolution to the same transport equation but solved in a strip of large width instead of the half plane, and we prove that

$$\text{for all } \gamma < \gamma^*, \quad \lim_{t \rightarrow +\infty} \inf_{|x| \leq e^{\gamma t}} u(x, t) > 0,$$

$$\text{where } \gamma^* = \frac{f'(0)}{1 + 2\alpha}.$$

Concerning the construction of a supersolution, as usual, we use the solution to the linearised problem at 0 of (0.0.12), and the explicit integral expression of its solution given by the theory of sectorial operators. Quite a long computation of this integral enables us to prove that

$$\text{for all } \gamma > \gamma^*, \quad \lim_{t \rightarrow +\infty} \inf_{|x| \geq e^{\gamma t}} u(x, t) = 0.$$

Thus, we get an asymptotic expression of the speed of propagation on the road. A more precise determination of $R_e(t)$ is investigated by numerical simulations.

In the field, the speed of propagation, in a direction that makes an angle $\theta \in (0, \frac{\pi}{2}]$ with the road, is linear in time. In fact, we prove that

$$\text{for all } c > \frac{c_{KPP}}{\sin(\theta)}, \quad \lim_{t \rightarrow +\infty} \sup_{r \geq ct} v(r \cos(\theta), r \sin(\theta), t) = 0,$$

and

$$\text{for all } 0 < c < \frac{c_{KPP}}{\sin(\theta)}, \quad \lim_{t \rightarrow +\infty} \inf_{0 \leq r \leq ct} v(r \cos(\theta), r \sin(\theta), t) > 0.$$

Finally, numerical simulations are carried out not only to illustrate known results in both cases $\alpha = 1$ and $\alpha \in (0, 1)$, but also to investigate the expansion shape of the level sets in the field. These simulations will reveal surprising qualitative properties such as the monotonicity of the density v and the role of the term $-\mu u + v|_{y=0}$.

C. Outline of the manuscript

We present here the work carried out from September 2011 to March 2014. Before that, we had, as said before, clarified the transition when α tends to 1. We have chosen not to include it in the manuscript, for the sake of homogeneity of the material presented here.

This thesis is divided into two parts. In the first part, we apply the method, defined above, to study the asymptotic location of the level sets of the solution to two different reaction-diffusion problems with fractional diffusion. In these cases, the method leads to an asymptotic expression of $R_e(t)$ defined in (0.0.2). Chapter 1 (in collaboration with X. Cabré and J.-M. Roquejoffre) is devoted to the study of the propagation in reaction-diffusion equations in periodic media. The results are published in [24]. Chapter 2 (in collaboration with M. Yangari) deals with monotone systems.

The second part of this thesis (in collaboration with H. Berestycki, J.-M. Roquejoffre and L. Rossi) is concerned with the influence of a line with fractional diffusion on Fisher-KPP propagation. In Chapter 3, we prove general results such as the existence, uniqueness, and regularity of the solution, as well as a principle comparison for this problem. Chapter 4 concerns the long time behaviour of the solution on the line and in the plane. Chapter 5 is devoted to numerical investigations concerning the influence of a line with standard and fractional diffusion on Fisher-KPP propagation.

Notations

Here we gather the main notations that will be used throughout the thesis.

Sets, Vectors and matrices :

- For any $m \in \mathbb{N}^*$, $\llbracket 1, m \rrbracket$ denotes the interval of integers between 1 and m .
- For $d \in \mathbb{N}^*$, S^{d-1} denotes the unit vectors of \mathbb{R}^d .
- The Euclidian norm of a vector x of \mathbb{C}^d is denoted by $|x|$ and the induced matrix norm of a matrix $A \in \mathcal{M}_d(\mathbb{C})$ is $|A|$.
- The matrix commutator $[\cdot, \cdot]$ is defined for $A \in \mathcal{M}_d(\mathbb{C})$ and $B \in \mathcal{M}_d(\mathbb{C})$ by $[A, B] = AB - BA$.

Complex numbers :

- The square root of a complex number $\lambda \in \mathbb{C}$ will be

$$\sqrt{\lambda} = |\lambda|^{\frac{1}{2}} e^{i\frac{\theta}{2}},$$

where $\theta = \arg \lambda \in (-\pi, \pi]$. With this notation $\Re(\sqrt{\lambda}) \in \mathbb{C} \setminus (-\infty, 0)$.

- For any angle $\theta \in \mathbb{R}$, the set $\mathbb{R}_+ e^{i\theta} \oplus \mathbb{R}_+ e^{-i\theta}$ denotes $\{\nu e^{i\theta}, \nu \geq 0\} \cup \{\nu e^{-i\theta}, \nu \geq 0\}$.

Functional spaces :

Let Ω be a smooth open set of \mathbb{R}^d with boundary $\partial\Omega$.

- For any function $h \in \mathcal{C}^\infty(\overline{\Omega})$, the trace operator and the normal trace operator are respectively denoted by $\gamma_0 h = h|_{\partial\Omega}$ and $\gamma_1 h = \partial_n h|_{\partial\Omega}$, where ∂_n is the derivative with respect to the outward unit normal to $\partial\Omega$.
- For $\Omega = \mathbb{R}^d$, $\mathcal{C}_0(\mathbb{R}^d)$ denotes the set of continuous functions in \mathbb{R}^d , that tend to 0 as $|x|$ goes to infinity.
- $\mathcal{C}_c^\infty(\Omega)$ denotes the set of compactly supported functions of class \mathcal{C}^∞ on Ω .
- $\mathcal{C}^{l, \frac{1}{2}}(\overline{\Omega} \times [0, T])$, for $l > 0$ and $T > 0$, denotes the set of functions that are continuous in $\overline{\Omega} \times [0, T]$, together with all derivatives of the form $\partial_x^s \partial_t^r$, for $s + 2r < l$, and such that, for any couple (s, r) satisfying $s + 2r = \lfloor l \rfloor$, the function $\partial_x^s \partial_t^r$ is $(l - \lfloor l \rfloor)$ -Hölder continuous with respect to space x and $\left(\frac{l - \lfloor l \rfloor}{2}\right)$ -Hölder continuous with respect to time t .

Subsolutions and supersolutions :

- For any elliptic operator L in a domain $\Omega \subset \mathbb{R}^d$, and any function f defined on $\Omega \times [0, +\infty)$, a subsolution (respectively supersolution) to a parabolic equation

$$\partial_t u(x, t) - Lu(x, t) = f(x, t), \quad x \in \Omega, t > 0,$$

is a solution, in the classical or weak sense, of this equation where the sign $=$ is replaced by \leq (respectively \geq).

Part I

Periodic case and monotone systems :
Asymptotic location of level sets

Chapter 1

Propagation in periodic media

1.1 Introduction

In this chapter, we are interested in the time asymptotic location of the level sets of solutions to the Cauchy problem

$$\begin{cases} \partial_t u + (-\Delta)^\alpha u = f(x, u), & x \in \mathbb{R}^d, t > 0, \\ u(x, 0) = u_0(x), & x \in \mathbb{R}^d, \end{cases} \quad (1.1.1)$$

in periodic media. Such heterogeneous environments are characterised by positive numbers ℓ_i , for $i \in \llbracket 1, d \rrbracket$. In the following, saying that a function $g : \mathbb{R}^d \rightarrow \mathbb{R}$ is periodic in each x_i -variable means that

$$g(x_1, \dots, x_k + \ell_k, \dots, x_d) \equiv g(x_1, \dots, x_d), \quad \text{for all } k \in \llbracket 1, d \rrbracket.$$

We denote by \mathcal{C}_ℓ the period cell :

$$\mathcal{C}_\ell = (0, \ell_1) \times \cdots \times (0, \ell_d). \quad (1.1.2)$$

The nonlinearity f refers to as a Fisher-KPP type nonlinearity in periodic media. We will assume that :

Hypothesis 1.1.1. *The function $f : \mathbb{R}^d \times \mathbb{R} \rightarrow \mathbb{R}$ is of class $\mathcal{C}^{0,\omega}$ ($\omega > 0$) in x , locally in s , locally Lipschitz continuous with respect to s . Moreover, for all $s \in \mathbb{R}$, $x \mapsto f(x, s)$ is \mathcal{C}_ℓ periodic, for all $x \in \mathbb{R}^d$, $f(x, 0) = 0$, $s \mapsto \frac{f(x, s)}{s}$ is decreasing, and there exists $M > 0$ such that for all $x \in \mathbb{R}^d$ and $s \geq M$: $f(x, s) \leq 0$.*

To prove the main results of this chapter, we need the following additional assumption on f .

Hypothesis 1.1.2. *Let M be defined in **Hypothesis 1.1.1**. There exist positive constants $c_{\delta_1} > 0$, $c_{\delta_2} > 0$ such that for all $s \in [0, M]$*

$$c_{\delta_1} s^{1+\delta_1} \leq \partial_s f(x, 0) s - f(x, s) \leq c_{\delta_2} s^{1+\delta_2},$$

where δ_1 and δ_2 are positive constants that satisfy

$$\delta_j \geq \frac{1 + \alpha}{d + 2\alpha}, \quad \text{for } j \in \{1, 2\}. \quad (1.1.3)$$

We will see later that (1.1.3) seems to be a technical assumption. The case $\delta_j > 0$ for $j \in \{1, 2\}$ is not treated in this thesis. The typical example first introduced in [78], that satisfies all our hypotheses, is $f(x, u) = u(\mu(x) - \nu(x)u)$, where μ and ν are periodic functions with the same period. The case when $\nu \equiv 1$ will be studied to underline the idea of the proof on a simple model.

The long time behaviour of the solution to (1.1.1) is encoded in λ_1 , the principal eigenvalue of the operator $(-\Delta)^\alpha - \partial_u f(x, 0)$. In fact, the following result proves that propagation is exponential in time with exponent equal to $\frac{|\lambda_1|}{d+2\alpha}$. It also enables us to follow the level sets of small values.

Theorem 1.1.3. *Assume that $\lambda_1 < 0$. Let u be the solution to (1.1.1) with u_0 piecewise continuous, nonnegative, $u_0 \not\equiv 0$, and*

$$u_0(x) = O(|x|^{-(d+2\alpha)}) \quad \text{as } |x| \rightarrow +\infty. \quad (1.1.4)$$

Then, the following two facts are satisfied :

- For every $\lambda > 0$, there exist $c_\lambda > 0$ and $t_\lambda > 0$ (all depending on λ and u_0) such that, for all $t \geq t_\lambda$

$$u(x, t) < \lambda, \quad \text{if } |x| \geq c_\lambda e^{\frac{|\lambda_1|}{d+2\alpha}t}.$$

- There exist $\varepsilon > 0$, $C_\varepsilon > 0$ and a time $t_\varepsilon > 0$ (all depending on ε and u_0) such that, for all $t \geq t_\varepsilon$,

$$u(x, t) > \varepsilon, \quad \text{if } |x| \leq C_\varepsilon e^{\frac{|\lambda_1|}{d+2\alpha}t}.$$

The proof of this theorem follows the method described in the introduction of the thesis. The following result proves the convergence of the solution to the steady state u_+ on sets that expand exponentially fast in time.

Theorem 1.1.4. *Assume $\lambda_1 < 0$. Let u_+ be the unique periodic positive steady solution to (1.1.1) and u the solution to (1.1.1) with u_0 piecewise continuous, $u_0 \not\equiv 0$, and satisfying*

$$0 \leq u_0 \leq u_+ \quad \text{in } \mathbb{R}^d, \quad \text{and } u_0(x) = O(|x|^{-(d+2\alpha)}) \quad \text{as } |x| \rightarrow +\infty. \quad (1.1.5)$$

Then, for any constant $\beta > 1$, there exist $c_\beta \in (0, C_\varepsilon)$ and a time $t_\beta > t_\varepsilon$, where C_ε and t_ε are given by Theorem 1.1.3, such that for all $t \geq t_\beta$ and for all $|x| \leq c_\beta e^{\frac{|\lambda_1|}{d+2\alpha}t}$

$$\beta^{-1}u_+(x) \leq u(x, t) \leq \beta u_+(x).$$

As a consequence of Theorem 1.1.3 and 1.1.4, we have the following result that gives a precise location of the level sets of values in $(0, \min u_+)$:

Theorem 1.1.5. *Assume that $\lambda_1 < 0$. Let u be such as in Theorem 1.1.3. We set $\tilde{c}_\lambda = \min(c_\lambda, c_\beta) > 0$ and a time $\tilde{t}_\lambda = \max(t_\lambda, t_\beta) > 0$, where c_λ and t_λ (respectively c_β and t_β) are given by Theorem 1.1.3 (respectively Theorem 1.1.4). Then, for every $\lambda \in (0, \min u_+)$, we have for all $t \geq \tilde{t}_\lambda$,*

$$\{x \in \mathbb{R}^d \mid u(x, t) = \lambda\} \subset \{x \in \mathbb{R}^d \mid c_\lambda e^{\frac{|\lambda_1|}{d+2\alpha}t} \leq |x| \leq c_\lambda^{-1} e^{\frac{|\lambda_1|}{d+2\alpha}t}\}. \quad (1.1.6)$$

Sections 1.2 to 1.5 of this chapter are devoted to apply the steps of the method given in section B.1. of the introduction. Problem (1.1.1), completed with an initial datum, is studied for example in [14] or [16], and the existence of the solution is well known, as well as a comparison principle for classical solutions. Section 1.2 corresponds to Step 2 of the method, that is a formal study leading to a family of candidates for supersolutions and subsolutions to (1.1.1). The effect of the diffusive terms on this family is studied in section 1.3. For the problem (1.1.1), an estimate of the solution at any fixed time $t_0 > 0$ is known, so there is nothing to do to prove Step 3. Section 1.4 concerns the choice of appropriate parameters to make \tilde{v}_* , given in (1.2.12), to be a supersolution or a subsolution to (1.1.1). Section 1.5 concerns the proof of Theorem 1.1.3, which means Step 4 of the method. Section 1.6 proves Theorem 1.1.4. In section 1.7, numerical simulations are investigated on the homogeneous model associated to (1.1.1). It suggests a universality in the behaviour of the level sets of the solution to (1.1.1) for a particular class of initial conditions that decay strictly faster than the fundamental solution.

Throughout this chapter, the maximum (respectively minimum) of a periodic function g on \mathbb{R}^d will be denoted by $\max_{\mathbb{R}^d} g$ (respectively $\min_{\mathbb{R}^d} g$) instead of $\max g$ (respectively $\min g$).

1.2 Formal analysis

For the sake of simplicity, we first choose the particular nonlinearity

$$f(x, u) = \mu(x)u - u^2,$$

where μ is periodic in each x_i -variable. This nonlinearity satisfies **Hypotheses 1.1.1** and **1.1.2**. The idea is to rescale formally equation (1.1.1) in the space variable in order to separate the important terms from those which will be negligible at large times. Two steps are needed.

Step 1. For $x \in \mathbb{R}^d$ and $t \geq 0$, we define

$$v(x, t) = \phi_1(x)^{-1}u(x, t). \quad (1.2.1)$$

To find the equation satisfied by v , we compute $(-\Delta)^\alpha u$ in terms of v and ϕ_1 . For $x \in \mathbb{R}^d$ and $t \geq 0$, we have

$$\begin{aligned} (-\Delta)^\alpha u(x, t) &= -C_{d,\alpha} PV \int_{\mathbb{R}^d} \frac{\phi_1(x) - \phi_1(\bar{x})}{|x - \bar{x}|^{d+2\alpha}} (v(x, t) - v(\bar{x}, t)) d\bar{x} \\ &\quad + C_{d,\alpha} PV \int_{\mathbb{R}^d} \frac{\phi_1(x) - \phi_1(\bar{x})}{|x - \bar{x}|^{d+2\alpha}} v(x, t) d\bar{x} + C_{d,\alpha} PV \int_{\mathbb{R}^d} \phi_1(x) \frac{v(x, t) - v(\bar{x}, t)}{|x - \bar{x}|^{d+2\alpha}} d\bar{x}. \end{aligned}$$

Let us consider the operator \tilde{K} defined by

$$\tilde{K}\tilde{g}(\cdot) = C_{d,\alpha} PV \int_{\mathbb{R}^d} \frac{\phi_1(\cdot) - \phi_1(\bar{x})}{|\cdot - \bar{x}|^{d+2\alpha}} (\tilde{g}(\cdot) - \tilde{g}(\bar{x})) d\bar{x}, \quad (1.2.2)$$

where \tilde{g} is any function in \mathbb{R}^d for which the right hand side is finite. Thus

$$(-\Delta)^\alpha u = -\tilde{K}v + v(-\Delta)^\alpha \phi_1 + \phi_1(-\Delta)^\alpha v. \quad (1.2.3)$$

The definition of ϕ_1 and the fact that $\lambda_1 < 0$ gives for all $x \in \mathbb{R}^d$ and $t > 0$:

$$\phi_1(x) \partial_t v + \phi_1(x) (-\Delta)^\alpha v - \tilde{K}v = |\lambda_1| \phi_1(x) v - \phi_1(x)^2 v^2. \quad (1.2.4)$$

Step 2. For $y \in \mathbb{R}^d$ and $t \geq 0$, we define

$$w(y, t) = v(yr(t), t), \quad \text{for } r(t) = e^{\frac{|\lambda_1|t}{d+2\alpha}}. \quad (1.2.5)$$

In the sequel, K is the linear operator defined by

$$Kg(y) = C_{d,\alpha} PV \int_{\mathbb{R}^d} \frac{\phi_1(yr(t)) - \phi_1(\bar{y}r(t))}{|y - \bar{y}|^{d+2\alpha}} (g(y) - g(\bar{y})) d\bar{y}, \quad (1.2.6)$$

where g is any function in \mathbb{R}^d for which the right hand side is finite. The equation solved by w is obtained from (1.2.4) as follows :

– For $y \in \mathbb{R}^d$ and $t > 0$, we have :

$$\partial_t w(y, t) = r'(t) y \cdot \partial_y v(yr(t), t) + \partial_t v(yr(t), t) = \frac{|\lambda_1|}{d+2\alpha} y \cdot \partial_y w(y, t) + \partial_t v(yr(t), t),$$

and :

$$(-\Delta)^\alpha w(y, t) = r(t)^{2\alpha} (-\Delta)^\alpha v(yr(t), t).$$

- Applying the definitions of K given in (1.2.6), and \tilde{K} in (1.2.2), respectively to $y \mapsto w(y, t)$ and $y \mapsto v(yr(t), t)$ for any $t > 0$, we have

$$\begin{aligned} Kw(y, t) &= C_{d,\alpha} PV \int_{\mathbb{R}^d} \frac{\phi_1(yr(t)) - \phi_1(\bar{x})}{|y - \bar{x}r(t)|^{d+2\alpha}} (v(yr(t), t) - v(\bar{x}, t)) r(t)^{-d} d\bar{x} \\ &= r(t)^{2\alpha} C_{d,\alpha} PV \int_{\mathbb{R}^d} \frac{\phi_1(yr(t)) - \phi_1(\bar{x})}{|yr(t) - \bar{x}|^{d+2\alpha}} (v(yr(t), t) - v(\bar{x}, t)) d\bar{x} \\ &= r(t)^{2\alpha} \tilde{K} v(yr(t), t). \end{aligned}$$

Consequently, for $y \in \mathbb{R}^d$ and $t > 0$, w solves

$$\partial_t w - \frac{|\lambda_1|}{d+2\alpha} y \cdot \partial_y w + r(t)^{-2\alpha} \left[(-\Delta)^{\alpha} w - \frac{Kw}{\phi_1(yr(t))} \right] = |\lambda_1| w - \phi_1(yr(t)) w^2. \quad (1.2.7)$$

If we formally neglect the term $r(t)^{-2\alpha} \left[(-\Delta)^{\alpha} w - \frac{Kw}{\phi_1(yr(t))} \right]$ which should go to 0 as $t \rightarrow +\infty$, we get the transport equation

$$\partial_t \tilde{w} - \frac{|\lambda_1|}{d+2\alpha} y \cdot \partial_y \tilde{w} = |\lambda_1| \tilde{w} - \phi_1(yr(t)) \tilde{w}^2, \quad y \in \mathbb{R}^d, t > 0, \quad (1.2.8)$$

with an initial condition \tilde{w}_0 to be chosen later. Equation (1.2.8) has an explicit solution. In fact, for any fixed $y \in \mathbb{R}^d$, we define

$$\psi(t) = \tilde{w}(yr(t)^{-1}, t).$$

Thus, using the definition of r given in (1.2.5), we have

$$\psi'(t) = |\lambda_1| \tilde{w}(yr(t)^{-1}, t) - \phi_1(y) \tilde{w}^2(yr(t)^{-1}, t) = |\lambda_1| \psi(t) - \phi_1(y) \psi^2(t),$$

and the function ψ^{-1} solves for $t > 0$

$$(\psi^{-1})'(t) = -|\lambda_1| (\psi^{-1}(t) - |\lambda_1|^{-1} \phi_1(y)).$$

Since $\psi(0) = \tilde{w}_0(y)$, we obtain

$$\psi(t) = \frac{\tilde{w}_0(y)}{|\lambda_1|^{-1} \phi_1(y) \tilde{w}_0(y) + (1 - |\lambda_1|^{-1} \phi_1(y) \tilde{w}_0(y)) e^{-|\lambda_1| t}}.$$

Finally, equation (1.2.8) is solved as:

$$\tilde{w}(y, t) = \frac{\tilde{w}_0(yr(t))}{|\lambda_1|^{-1} \phi_1(yr(t)) \tilde{w}_0(yr(t)) + e^{-|\lambda_1| t} (1 - |\lambda_1|^{-1} \phi_1(yr(t)) \tilde{w}_0(yr(t)))}.$$

Taking into account (see for instance [26]) that, for all $t > 0$, $|x|^{d+2\alpha} u(x, t)$ is uniformly bounded from above and below (but of course not uniformly in t), it is natural to specialise

$$\tilde{w}_0(y) = \frac{1}{1 + |y|^{d+2\alpha}}.$$

In this case, we have

$$\tilde{w}(y, t) = \frac{1}{|\lambda_1|^{-1} \phi_1(yr(t))(1 - e^{-|\lambda_1|t}) + e^{-|\lambda_1|t} + |y|^{d+2\alpha}}.$$

Keeping in mind that ϕ_1 is bounded from above and below and that t tends to $+\infty$, we revert to the function $v(x, t) = w(xr(t)^{-1}, t)$ and consider the following family of functions, modelled by \tilde{w} :

$$\tilde{v}(x, t) = \frac{a}{1 + b(t) |x|^{d+2\alpha}}, \quad \tilde{u}(x, t) = \phi_1(x) \tilde{v}(x, t). \quad (1.2.9)$$

The idea will be to adjust $a > 0$ and $b(t)$ asymptotically proportional to $e^{-|\lambda_1|t}$ so that the function \tilde{u} serves as a subsolution or a supersolution to (1.1.1).

We now turn to the case of a more general nonlinearity f that satisfies **Hypotheses 1.1.1** and **1.1.2**.

The principal eigenvalue λ_1 of the operator $(-\Delta)^\alpha - \partial_u f(x, 0)I$ is supposed to be negative. We call ϕ_1 the principal eigenfunction, associated to λ_1 , solution to

$$\begin{cases} (-\Delta)^\alpha \phi_1(x) - \partial_u f(x, 0) \phi_1(x) = \lambda_1 \phi_1(x), & x \in \mathbb{R}^d, \\ \phi_1 \text{ periodic, } \phi_1 > 0, & \|\phi_1\| = 1. \end{cases}$$

The existence, uniqueness and regularity of ϕ_1 is given, for instance, in [16].

The formal analysis done for the particular nonlinearity $f(x, u) = \mu(x)u - u^2$ is valid up to the transport equation (1.2.8). For a general nonlinearity f that satisfies **Hypotheses 1.1.1** and **1.1.2**, this transport equation becomes, for $y \in \mathbb{R}^d$, $t > 0$:

$$\partial_t \tilde{w} - \frac{|\lambda_1|}{d+2\alpha} y \cdot \partial_y \tilde{w} = |\lambda_1| \tilde{w} + \frac{f(yr(t), \phi_1(yr(t)) \tilde{w})}{\phi_1(yr(t))} - \partial_u f(yr(t), 0) \tilde{w}, \quad (1.2.10)$$

where \tilde{w} is an approximation of $w(y, t) = \phi_1(yr(t))^{-1} u(yr(t), t)$, defined by (1.2.1) and (1.2.5). Under **Hypothesis 1.1.2** on f , the candidates for a supersolution or a subsolution to (1.2.10) solves

$$\partial_t \tilde{w}_* - \frac{|\lambda_1|}{d+2\alpha} y \cdot \partial_y \tilde{w}_* = |\lambda_1| \tilde{w}_* - c_\delta \phi_1(yr(t))^\delta \tilde{w}_*^{1+\delta}, \quad y \in \mathbb{R}^d, t > 0, \quad (1.2.11)$$

where \tilde{w}_* will be a supersolution (respectively subsolution) to (1.2.10) for $\delta = \delta_1$ (respectively $\delta = \delta_2$). Equation (1.2.11), completed with an initial condition $\tilde{w}_*(\cdot, 0)$ to be chosen later, has, once again, an explicit solution. Noticing that, for any $y \in \mathbb{R}^d$, the function $\psi(t) := \tilde{w}_*(yr(t)^{-1}, t)^{-\delta}$ solves for $t > 0$

$$\psi'(t) = -|\lambda_1| \delta (\psi(t) - c_\delta \phi(y)^\delta |\lambda_1|^{-1}),$$

we get for all $y \in \mathbb{R}^d$ and $t \geq 0$

$$\tilde{w}_*(y, t) = \frac{|\lambda_1| \tilde{w}_*(yr(t), 0)^\delta}{c_\delta \phi_1(yr(t))^\delta \tilde{w}_*(yr(t), 0)^\delta + e^{-\delta|\lambda_1|t} (|\lambda_1| - c_\delta \phi_1(yr(t))^\delta \tilde{w}_*(yr(t), 0)^\delta)}.$$

As in the case $f(x, u) = \mu(x)u - u^2$, it is natural to specialise

$$\tilde{w}_*(y, 0) = \frac{1}{1 + |y|^{d+2\alpha}}.$$

Since ϕ_1 is bounded and t tends to $+\infty$, the family of functions associated to the equation (1.2.11), depending on a constant $a > 0$ and a function b defined on \mathbb{R}_+ , is

$$\tilde{v}_*(x, t) = \frac{a}{(1 + b(t)|x|^{(d+2\alpha)\delta})^{\frac{1}{\delta}}}, \quad \tilde{u}_*(x, t) = \phi_1(x)\tilde{v}_*(x, t). \quad (1.2.12)$$

Note that this analysis is consistent with the case $f(x, u) = \mu(x)u - u^2$, since for $\delta = 1$, the function \tilde{u}_* is equal to \tilde{u} defined in (1.2.9).

In the sequel, we prove that adjusting the constant $a > 0$ and the function $b(t) \in (0, 1]$ asymptotically proportional to $e^{-\delta|\lambda_1|t}$, the function \tilde{u}_* serves as a supersolution (for $\delta = \delta_1$) or a subsolution (for $\delta = \delta_2$) to (1.1.1).

1.3 Effect of $(-\Delta)^\alpha$ on \tilde{u}_*

The previous formal analysis consisted in neglecting the diffusive terms in (1.2.7). In this section, we quantify the effect of the operators $(-\Delta)^\alpha$ on the function \tilde{u}_* , given in (1.2.12). From (1.2.3), it is sufficient to study the effect of $(-\Delta)^\alpha$ and \tilde{K} , defined in (1.2.2), on the function \tilde{v}_* , given in (1.2.12).

Let us define γ , any constant that satisfies

$$\gamma \in \begin{cases} [0, 2\alpha) & \text{if } 0 < \alpha < \frac{1}{2}, \\ (2\alpha - 1, 1] & \text{if } \frac{1}{2} \leq \alpha < 1. \end{cases} \quad (1.3.1)$$

Note that the constant γ does not exist if $\alpha = 1$, which confirms that our results are not valid if the diffusion is represented by the standard Laplace operator ($\alpha = 1$).

The following lemma, stated in [24] without proof and independently proved in [21] for functions of class $\mathcal{C}^2(\mathbb{R}^d)$, answers the question. It is quite simple, but we give its details for completeness.

Lemma 1.3.1. *Let \tilde{K} and γ be defined respectively in (1.2.2) and (1.3.1). Let h be a real positive function in $\mathcal{C}^{1,\alpha}(\mathbb{R}^d)$, radially symmetric, decreasing in $|x|$ and satisfying,*

for a constant $\beta \in (0, d + 2\alpha]$, $h(x) = O(|x|^{-\beta})$ as $|x|$ tends to $+\infty$. If there exists a constant $\eta \geq 1 + \alpha$ such that, uniformly in $y \in B_1(0)$, we have

$$|h(x) - h(x + y) - \nabla h(x) \cdot y| |y|^{-\eta} = O(|x|^{-\beta}) \quad \text{as } |x| \rightarrow +\infty, \quad (1.3.2)$$

then there exists a constant $D > 1$ such that for all $x \in \mathbb{R}^d$ and all $\lambda \in (0, 1]$:

$$|(-\Delta)^\alpha(h(\lambda x))| \leq \frac{\lambda^{2\alpha} D}{1 + (\lambda |x|)^\beta} \quad \text{and} \quad \left| \tilde{K}(h(\lambda x)) \right| \leq \frac{\lambda^{2\alpha - \gamma} D}{1 + (\lambda |x|)^\beta}. \quad (1.3.3)$$

Remark 1.3.2. The proof is valid for any constant $\gamma > 2\alpha - 1$. However, we want the diffusive terms of (1.2.7) to be negligible, that is why we need to suppose $\gamma < 2\alpha$.

Remark 1.3.3. From the definitions of \tilde{v}_* and \tilde{u}_* in (1.2.12), it is easy to guess that this lemma will be used with

$$\beta = d + 2\alpha, \quad \lambda = b(t)^{\frac{1}{(d+2\alpha)\delta}} \quad \text{and} \quad h(x) = \frac{1}{(1 + |x|^{(d+2\alpha)\delta})^{\frac{1}{\delta}}}. \quad (1.3.4)$$

This function h is clearly positive, radially symmetric, bounded and has an admissible decay at infinity. Its regularity depends on the value of $(d + 2\alpha)\delta$.

- If $(d + 2\alpha)\delta \geq 2$, then h is $\mathcal{C}^2(\mathbb{R}^d)$ and its second derivative decays like $|x|^{d+2\alpha-2}$ for large values of $|x|$. Consequently, it satisfies all the assumptions of Lemma 1.3.1.
- If $(d + 2\alpha)\delta < 2$, the function h is $\mathcal{C}^1(\mathbb{R}^d)$. Its derivative h' behaves like $|x|^{(d+2\alpha)\delta-1}$ for values of $|x|$ in a neighbourhood of 0. Since δ satisfies (1.1.3), h' is \mathcal{C}^α close to 0. Thus, h satisfies all the assumptions of Lemma 1.3.1.

Thus, with the notations of (1.3.4), we have $\tilde{v}_*(x, t) = ah(\lambda x)$, and taking D larger if necessary in Lemma 1.3.1, we get for $x \in \mathbb{R}^d$ and $t > 0$

$$|(-\Delta)^\alpha \tilde{v}_*(x, t)| \leq Db(t)^{\frac{2\alpha}{(d+2\alpha)\delta}} \tilde{v}_*(x, t) \quad \text{and} \quad \left| \tilde{K} \tilde{v}_*(x, t) \right| \leq Db(t)^{\frac{2\alpha - \gamma}{(d+2\alpha)\delta}} \tilde{v}_*(x, t), \quad (1.3.5)$$

where γ is defined in (1.3.1).

Since $b(t)$ is expected to behave like $e^{-\delta|\lambda_1|t}$ as t tends to $+\infty$, from the definition of γ , we conclude that the term $(-\Delta)^\alpha \tilde{u}_*(x, t)$ should be negligible as time goes to $+\infty$ and has the same decay as \tilde{u}_* for large values of $|x|$.

Proof : We first prove the estimate that concerns $(-\Delta)^\alpha$ in (1.3.3). Since $h \in \mathcal{C}^{1,\alpha}(\mathbb{R}^d) \cap L^\infty(\mathbb{R}^d)$, using section 3.1 of [80] for instance, we conclude that $(-\Delta)^\alpha h$ exists and is bounded. We also know that this operator is 2α -homogeneous. Thus, we only need to prove that for all $x \in \mathbb{R}^d$

$$|(-\Delta)^\alpha h(x)| \leq \frac{D}{1 + |x|^\beta}. \quad (1.3.6)$$

Taking D large enough, it is sufficient to prove the result for large values of $|x|$. We define for $x \in \mathbb{R}^d$

$$I_1(x) = C_{d,\alpha} \int_{|y| \leq 1} \frac{h(x) - h(x+y)}{|y|^{d+2\alpha}} dy \quad \text{and} \quad I_2(x) = C_{d,\alpha} \int_{|y| \geq 1} \frac{h(x) - h(x+y)}{|y|^{d+2\alpha}} dy,$$

so that $(-\Delta)^\alpha h = I_1 + I_2$. It is usual (see [40] or [80] for example) to write I_1 as

$$I_1(x) = C_{d,\alpha} \int_{|y| \leq 1} \frac{h(x) - h(x+y) + \nabla h(x) \cdot y}{|y|^{d+2\alpha}} dy.$$

Assumption (1.3.2) gives the existence of a constant $\eta \geq 1 + \alpha$ such that for $|x|$ large enough :

$$|I_1(x)| \leq C \int_{|y| \leq 1} \frac{|y|^\eta}{|x|^\beta |y|^{d+2\alpha}} dy \leq \frac{D_1}{|x|^\beta}, \quad (1.3.7)$$

where C and D_1 are positive constants depending on α and d .

As for I_2 , for $|x|$ large enough, we have

$$\begin{aligned} |I_2(x)| &\leq C_{d,\alpha} \int_{|y| \geq 1} \frac{h(x)}{|y|^{d+2\alpha}} dy + C_{d,\alpha} \int_{|y| \geq 1} \frac{h(x+y)}{|y|^{d+2\alpha}} dy \\ &\leq \frac{C}{|x|^\beta} + C_{d,\alpha} \int_{|y| \geq \frac{|x|}{2}} \frac{h(x+y)}{|y|^{d+2\alpha}} dy + C_{d,\alpha} \int_{1 \leq |y| \leq \frac{|x|}{2}} \frac{h(x+y)}{|y|^{d+2\alpha}} dy. \end{aligned}$$

For $|y| \leq \frac{|x|}{2}$, we have $|x+y| \geq |x| - |y| \geq \frac{|x|}{2}$, and the assumptions on h lead to

$$h(x+y) \leq h\left(\frac{x}{2}\right) \leq \frac{C}{|x|^\beta},$$

for a positive constant C . This implies

$$|I_2(x)| \leq \frac{C}{|x|^\beta} + \frac{2^{d+2\alpha} C_{d,\alpha}}{|x|^{d+2\alpha}} \int_{\mathbb{R}^d} h(z) dz + \frac{C}{|x|^\beta} \int_{1 \leq |y|} \frac{1}{|y|^{d+2\alpha}} dy \leq \frac{C}{|x|^\beta},$$

where C is a positive constant. Thus, there exists a constant $D_2 > 0$ such that for all $x \in \mathbb{R}^d$

$$|I_2(x)| \leq \frac{D_2}{1 + |x|^\beta}. \quad (1.3.8)$$

With (1.3.7) and (1.3.8), we have the estimate (1.3.6) on $(-\Delta)^\alpha h$, which proves the first inequality of (1.3.3).

We now prove the second inequality of (1.3.3), that concerns the operator \tilde{K} . With the change of variables $\tilde{x} = \lambda \bar{x}$, with $\lambda > 0$, in the expression (1.2.2) of $\tilde{K}(h(\lambda x))$, we have

$$\tilde{K}(h(\lambda x)) = \lambda^{2\alpha} C_{d,\alpha} \int_{\mathbb{R}^d} \frac{\phi_1(x) - \phi_1(\lambda^{-1} \tilde{x})}{|\lambda x - \tilde{x}|^{d+2\alpha}} (h(\lambda x) - h(\tilde{x})) d\tilde{x}.$$

Since $\phi_1 \in \mathcal{C}^1(\mathbb{R}^d) \cap L^\infty(\mathbb{R}^d)$ and $h \in \mathcal{C}^1(\mathbb{R}^d) \cap L^\infty(\mathbb{R}^d)$, this integral converges in \mathbb{R}^d . For $x \in \mathbb{R}^d$, we have to estimate

$$J(x) = \lambda^{2\alpha} C_{d,\alpha} \int_{\mathbb{R}^d} \frac{\phi_1(\lambda^{-1}x) - \phi_1(\lambda^{-1}\tilde{x})}{|x - \tilde{x}|^{d+2\alpha}} (h(x) - h(\tilde{x})) d\tilde{x},$$

at point λx . We define for $x \in \mathbb{R}^d$ and $t \geq 0$

$$J_1(x) = \lambda^{2\alpha} C_{d,\alpha} \int_{B_1(x)} \frac{\phi_1(\lambda^{-1}x) - \phi_1(\lambda^{-1}\tilde{x})}{|x - \tilde{x}|^{d+2\alpha}} (h(x) - h(\tilde{x})) d\tilde{x},$$

$$\text{and } J_2(x) = \lambda^{2\alpha} C_{d,\alpha} \int_{\mathbb{R}^d \setminus B_1(x)} \frac{\phi_1(\lambda^{-1}x) - \phi_1(\lambda^{-1}\tilde{x})}{|x - \tilde{x}|^{d+2\alpha}} (h(x) - h(\tilde{x})) d\tilde{x},$$

so that $J = J_1 + J_2$ in \mathbb{R}^d .

- Estimate of J_2 : Since ϕ_1 is bounded, the function $|J_2|$ is bounded from above in a similar fashion as $|I_2|$. Thus, there exists a constant $D_3 > 0$ such that for all $x \in \mathbb{R}^d$

$$|J_2(x)| \leq \frac{D_3}{1 + |x|^\beta}. \quad (1.3.9)$$

- Estimate of J_1 : Since ϕ_1 is $\mathcal{C}^1(\mathbb{R}^d)$, we get for $x \in \mathbb{R}^d$ and $t \geq 0$:

$$|J_1(x)| \leq C_{d,\alpha} \int_{B_1(x)} \frac{\lambda^{2\alpha-\gamma} |x - \tilde{x}|^\gamma}{|x - \tilde{x}|^{d+2\alpha}} \sup_{z \in (x, \tilde{x})} |\nabla h(z)| |x - \tilde{x}| d\tilde{x} \leq C \lambda^{2\alpha-\gamma}, \quad (1.3.10)$$

where $C > 0$ is a constant and γ is defined in (1.3.1). This inequality imposes the condition $\gamma \leq 1$.

To get an upper bound that decays like $|x|^{-\beta}$ for large values of $|x|$, it is sufficient to know the behaviour of $J_1(x)$ for large values of $|x|$. From (1.3.2) and the behaviour of h at infinity, the function $\sup_{z \in (x, \tilde{x})} |\nabla h(z)|$ decays faster than $|x|^{-\beta}$ for large values of $|x|$. Consequently, we have a more precise estimate than (1.3.10), that is, for $|x|$ large enough, and $t \geq 0$:

$$|J_1(x)| \leq \frac{C \lambda^{2\alpha-\gamma}}{|x|^\beta} \int_{B_1(x)} \frac{1}{|x - \tilde{x}|^{d+2\alpha-\gamma-1}} d\tilde{x} \leq \frac{C \lambda^{2\alpha-\gamma}}{|x|^\beta}, \quad (1.3.11)$$

where C is a positive constant. This inequality imposes $\gamma > 2\alpha - 1$.

Finally, for any $\lambda \in (0, 1]$, using (1.3.9) and (1.3.11), we have the existence of a constant $D_4 > 0$ such that for $x \in \mathbb{R}^d$ and $t \geq 0$:

$$|J(x)| \leq \frac{\lambda^{2\alpha-\gamma} D_4}{1 + |x|^\beta}.$$

At the point λx , this inequality implies for $x \in \mathbb{R}^d$ and $t \geq 0$

$$\left| \tilde{K}(h(\lambda x)) \right| \leq \frac{\lambda^{2\alpha-\gamma} D_4}{1 + (\lambda |x|)^\beta}.$$

Taking $D = \max_{i \in [1,4]} D_i$ ends the proof. \blacksquare

1.4 Construction of subsolutions and supersolutions

The following lemma makes explicit the choice of the constant a and the function $b(t)$ in the expression of \tilde{u}_* in (1.2.12), in order to have supersolutions and subsolutions to (1.1.1).

Lemma 1.4.1. *Let ϕ_1 be the principal eigenfunction of the operator $(-\Delta)^\alpha - \partial_u f(x, 0)I$, $\delta_1, \delta_2, c_{\delta_1}, c_{\delta_2}$ be given by **Hypothesis 1.1.2** and γ be defined in (1.3.1). Taking D larger if necessary in Lemma 1.3.1, we set*

$$M := D \left((\min \phi_1)^{-1} + 1 \right) > \min(1, |\lambda_1|). \quad (1.4.1)$$

For any positive constants $\underline{a}, \bar{a}, \underline{B}, \bar{B}$, we define for $x \in \mathbb{R}^d$ and $t \geq 0$

$$\bar{u}(x, t) = \frac{\bar{a}\phi_1(x)}{(1 + \bar{b}(t) |x|^{(d+2\alpha)\delta_1})^{\frac{1}{\delta_1}}} \quad \text{with } \bar{b}(t) = (-M |\lambda_1|^{-1} + \bar{B}^{-\frac{2\alpha-\gamma}{(d+2\alpha)\delta_1}} e^{\frac{2\alpha-\gamma}{d+2\alpha} |\lambda_1| t})^{-\frac{d+2\alpha}{2\alpha-\gamma} \delta_1},$$

and

$$\underline{u}(x, t) = \frac{\underline{a}\phi_1(x)}{(1 + \underline{b}(t) |x|^{(d+2\alpha)\delta_2})^{\frac{1}{\delta_2}}} \quad \text{with } \underline{b}(t) = (M |\lambda_1|^{-1} + \underline{B}^{-\frac{2\alpha-\gamma}{(d+2\alpha)\delta_2}} e^{\frac{2\alpha-\gamma}{d+2\alpha} |\lambda_1| t})^{-\frac{d+2\alpha}{2\alpha-\gamma} \delta_2}.$$

The following two facts are true.

– For any constant $\bar{B} > 1$, we set

$$t_0 = \frac{d+2\alpha}{(2\alpha-\gamma) |\lambda_1|} \ln(2M |\lambda_1|^{-1} \bar{B}^{\frac{2\alpha-\gamma}{(d+2\alpha)\delta_1}}), \quad (1.4.2)$$

so that for $t \geq t_0$

$$\bar{B} e^{-\delta_1 |\lambda_1| t} \leq \bar{b}(t) \leq 1. \quad (1.4.3)$$

If $\bar{a} \geq (2\delta_1 M c_{\delta_1}^{-1})^{\frac{1}{\delta_1}} (\min \phi_1)^{-1}$, then \bar{u} is a supersolution to (1.1.1) for $t > t_0$.

– If $\underline{B} \in (0, (|\lambda_1| 2^{-1} M^{-1})^{\frac{d+2\alpha}{2\alpha-\gamma} \delta_2})$ and $\underline{a} \in (0, (\max \phi_1)^{-1} (2^{-1} \delta_2 |\lambda_1| c_{\delta_2})^{\frac{1}{\delta_2}})$, then the function \underline{b} satisfies, for all $t \geq 0$,

$$0 \leq \underline{b}(t) \leq \underline{B} e^{-\delta_2 |\lambda_1| t} \leq \underline{B} \leq 1 \quad \text{and} \quad \underline{b}(0) \geq \left(\frac{2}{3} \right)^{\frac{d+2\alpha}{2\alpha-\gamma} \delta_2} \underline{B}, \quad (1.4.4)$$

and \underline{u} is a subsolution to (1.1.1) for $t > 0$.

Proof : We first construct a supersolution \bar{u} of the form \tilde{u}_* given by (1.2.12) with $\delta = \delta_1$. We have to find a and $b(t)$, that we denote by \bar{a} and $\bar{b}(t)$, such that

$$\bar{u}(x, t) = \phi_1(x) \tilde{v}_*(x, t) = \frac{\bar{a} \phi_1(x)}{(1 + \bar{b}(t) |x|^{(d+2\alpha)\delta_1})^{\frac{1}{\delta_1}}}$$

is a supersolution to (1.1.1).

We take $D > |\lambda_1|$ in (1.3.5) and define M by (1.4.1). Given any constant $\bar{B} > 1$, let \bar{b} be the solution to

$$\begin{cases} \bar{b}'(t) + \delta_1 M \bar{b}(t)^{\frac{2\alpha-\gamma}{(d+2\alpha)\delta_1}+1} + \delta_1 |\lambda_1| \bar{b}(t) = 0, \\ \bar{b}(0) = \left(-M |\lambda_1|^{-1} + \bar{B}^{-\frac{2\alpha-\gamma}{(d+2\alpha)\delta_1}} \right)^{-\frac{d+2\alpha}{2\alpha-\gamma} \delta_1}, \end{cases} \quad (1.4.5)$$

whose explicit solution is

$$\bar{b}(t) = \left(M |\lambda_1|^{-1} + \bar{B}^{-\frac{2\alpha-\gamma}{d+2\alpha}} e^{|\lambda_1| \frac{2\alpha-\gamma}{(d+2\alpha)\delta_1} t} \right)^{-\frac{d+2\alpha}{2\alpha-\gamma} \delta_1}.$$

Let t_0 be given by (1.4.2). For $t \geq t_0$, inequality (1.4.3) is obvious, and implies $\bar{b}(t)^{\frac{2\alpha}{(d+2\alpha)\delta_1}} \leq \bar{b}(t)^{\frac{2\alpha-\gamma}{(d+2\alpha)\delta_1}}$. Using $\lambda_1 < 0$, **Hypothesis 1.1.2** on f and (1.3.5), we get for $x \in \mathbb{R}^d$ and $t > t_0$

$$\begin{aligned} \partial_t \bar{u} + (-\Delta)^\alpha \bar{u} - f(x, \bar{u}) &= \phi_1 \partial_t \tilde{v}_* + \phi_1 (-\Delta)^\alpha \tilde{v}_* - \tilde{K} \tilde{v}_* - |\lambda_1| \bar{u} + \partial_u f(x, \bar{u}) - f(x, \bar{u}) \\ &\geq \frac{\bar{a} \phi_1 |x|^{d+2\alpha}}{\delta_1 (1 + \bar{b}(t) |x|^{(d+2\alpha)\delta_1})^{\frac{1}{\delta_1}+1}} \left(-\bar{b}'(t) - \delta_1 M \bar{b}(t)^{\frac{2\alpha-\gamma}{(d+2\alpha)\delta_1}+1} - \delta_1 |\lambda_1| \bar{b}(t) \right) \\ &\quad + \frac{\bar{a} \phi_1}{(1 + \bar{b}(t) |x|^{(d+2\alpha)\delta_1})^{\frac{1}{\delta_1}+1}} \left(-\delta_1 M \bar{b}(t)^{\frac{2\alpha-\gamma}{(d+2\alpha)\delta_1}} - \delta_1 |\lambda_1| + c_{\delta_1} \bar{a}^{\delta_1} \phi_1^{\delta_1} \right). \end{aligned}$$

We use (1.4.5) and choose $\bar{a} \geq (2\delta_1 M c_{\delta_1}^{-1})^{\frac{1}{\delta_1}} (\min \phi_1)^{-1}$ to make the right hand side to be greater than or equal to 0.

The construction of a subsolution of the form

$$\underline{u}(x, t) = \phi_1(x) \tilde{v}_*(x, t) = \frac{\underline{a} \phi_1(x)}{(1 + \underline{b}(t) |x|^{(d+2\alpha)\delta_2})^{\frac{1}{\delta_2}}},$$

is done in a similar fashion. Given any $\underline{B} \in \left(0, (M^{-1} 2^{-1} |\lambda_1|)^{\frac{d+2\alpha}{2\alpha-\gamma} \delta_2} \right)$, we consider \underline{b} the solution to

$$\begin{cases} \underline{b}'(t) - \delta_2 M \underline{b}(t)^{\frac{2\alpha-\gamma}{(d+2\alpha)\delta_2}+1} + \delta_2 |\lambda_1| \underline{b}(t) = 0, \\ \underline{b}(0) = \left(M |\lambda_1|^{-1} + \underline{B}^{-\frac{2\alpha-\gamma}{(d+2\alpha)\delta_2}} \right)^{-\frac{d+2\alpha}{2\alpha-\gamma} \delta_2}. \end{cases} \quad (1.4.6)$$

An explicit expression of \underline{b} is

$$\underline{b}(t) = (M |\lambda_1|^{-1} + \underline{B}^{-\frac{2\alpha-\gamma}{(d+2\alpha)\delta_2}} e^{|\lambda_1| \frac{2\alpha-\gamma}{d+2\alpha} t})^{-\frac{d+2\alpha}{2\alpha-\gamma} \delta_2}.$$

Since $\underline{B} \in \left(0, (M^{-1} 2^{-1} |\lambda_1|)^{\frac{d+2\alpha}{2\alpha-\gamma} \delta_2}\right)$ and $M \geq |\lambda_1|$, for all $t \geq 0$, we have (1.4.4). As previously, with **Hypothesis 1.1.2** on f , we have

$$\begin{aligned} \partial_t \underline{u} + (-\Delta)^\alpha \underline{u} - f(x, \underline{u}) &= \phi_1 \partial_t \tilde{v}_* + \phi_1 (-\Delta)^\alpha \tilde{v}_* - \tilde{K} \tilde{v}_* - |\lambda_1| \underline{u} + \partial_u f(x, \underline{u}) - f(x, \underline{u}) \\ &\leq \frac{\underline{a} \phi_1 |x|^{d+2\alpha}}{\delta_2 (1 + \underline{b}(t) |x|^{(d+2\alpha)\delta_2})^{\frac{1}{\delta_2} + 1}} \left(-\underline{b}'(t) + \delta_2 M \underline{b}(t)^{\frac{2\alpha-\gamma}{(d+2\alpha)\delta_2} + 1} - \delta_2 |\lambda_1| \underline{b}(t) \right) \\ &\quad + \frac{\underline{a} \phi_1}{(1 + \underline{b}(t) |x|^{(d+2\alpha)\delta_2})^{\frac{1}{\delta_2} + 1}} \left(\delta_2 M \underline{b}(t)^{\frac{2\alpha-\gamma}{(d+2\alpha)\delta_2}} - \delta_2 |\lambda_1| + c_{\delta_2} \underline{a}^{\delta_2} \phi_1^{\delta_2} \right). \end{aligned}$$

Finally, using (1.4.6) and taking $\underline{a} \in (0, (\max \phi_1)^{-1} (2^{-1} \delta_2 |\lambda_1| c_{\delta_2})^{\frac{1}{\delta_2}})$, we get a subsolution to (1.1.1) for $t > 0$. ■

1.5 Proof of Theorem 1.1.3

The first point of Theorem 1.1.3 to be proved is the existence of a constant $c_\lambda > 0$ and a time $t_\lambda > 0$ such that, for $t \geq t_\lambda$

$$\{x \in \mathbb{R}^d \mid |x| > c_\lambda e^{\frac{|\lambda_1|}{d+2\alpha} t}\} \subset \{x \in \mathbb{R}^d \mid u(x, t) < \lambda\}. \quad (1.5.1)$$

From Lemma 1.4.1, we know that \underline{u} is a supersolution to (1.1.1) as soon as $t \geq t_0$, where t_0 is given by (1.4.2). To make it above u for such times, it remains to compare these two solutions at time t_0 .

Let us fix $\bar{B} > 1$. Due to the assumption (1.1.4) on u_0 , there exist constants $\beta > 1$ and $A_\beta > 1$, such that for $|x| \geq A_\beta$,

$$u_0(x) \leq \frac{\beta}{|x|^{d+2\alpha}}.$$

We set

$$a_1 = 2^{\frac{1}{\delta_1}} A_\beta^{d+2\alpha} (\min \phi_1)^{-1} \max_{|x| \leq A_\beta} u_0(x). \quad (1.5.2)$$

In order to use the maximum principle, we have to verify that, given any constant $\bar{B} > 1$ and $\bar{a} \geq \max(2M\beta(\min \phi_1)^{-1}, a_1)$, where a_1 is defined in (1.5.2), we have

$$u_0 \leq \bar{u}(\cdot, t_0).$$

Using (1.4.3), a simple computation gives

- if $|x| \geq A_\beta$: $\bar{u}(x, t_0) \geq \frac{\beta}{|x|^{d+2\alpha}} \geq u_0(x)$,
- if $|x| \leq A_\beta$: $\bar{u}(x, t_0) \geq \frac{a_1 \min \phi_1}{(1 + A_\beta^{(d+2\alpha)\delta_1})^{\frac{1}{\delta_1}}} \geq \max_{|x| \leq A_\beta} u_0(x) \geq u_0(x)$.

Finally, using the maximum principle and (1.4.3), we get for all $x \in \mathbb{R}^d$ and $t \geq 0$

$$\begin{aligned} u(x, t) &\leq \bar{u}(x, t + t_0) = \frac{\bar{a}\phi_1(x)}{(1 + \bar{b}(t + t_0) |x|^{(d+2\alpha)\delta_1})^{\frac{1}{\delta_1}}} \\ &\leq \frac{\bar{a}\phi_1(x)}{(1 + \bar{B}e^{-\delta_1|\lambda_1|t}e^{-\delta_1|\lambda_1|t_0} |x|^{(d+2\alpha)\delta_1})^{\frac{1}{\delta_1}}}. \end{aligned}$$

For any $\lambda > 0$, we set

$$c_\lambda^{d+2\alpha} = \lambda^{-1} \bar{B}^{-\frac{1}{\delta_1}} e^{|\lambda_1|t_0} \bar{a} \max \phi_1,$$

which proves (1.5.1) for $t_\lambda = t_0$.

We now prove the second point of Theorem 1.1.3, that is the existence of constants $\varepsilon > 0$, $C_\varepsilon > 0$, $t_\varepsilon > 0$ such that, for all $t \geq t_\varepsilon$

$$u(x, t) > \varepsilon, \quad \text{if} \quad |x| \leq C_\varepsilon e^{\frac{|\lambda_1|}{d+2\alpha}t}. \quad (1.5.3)$$

Let us define

$$t_1 > \max \left\{ (2^{-1}\delta_2 |\lambda_1| c_{\delta_2})^{\frac{2\alpha}{d\delta_2}}, (\min u_+)^{-\frac{2\alpha}{d}}, (3M |\lambda_1|^{-1})^{\frac{2\alpha}{2\alpha-\gamma}} \right\}. \quad (1.5.4)$$

We prove that $u(\cdot, t)$ is above $\underline{u}(\cdot, t - t_1)$, for all $t \geq t_1$. We first compare $u(\cdot, t_1)$ and $\underline{u}(\cdot, 0)$. From **Hypothesis 1.1.2** on f , for all $x \in \mathbb{R}^d$ and $t \geq t_1$, we have

$$f(x, u) \leq \partial_u f(x, 0)u - c_{\delta_1} u^{1+\delta_1} \leq (\max \partial_u f(x, 0) - c_{\delta_1} u^{\delta_1})u.$$

The standard maximum principle applied to (1.1.1) gives

$$u \in \left[0, (c_{\delta_1}^{-1} \max \partial_u f(x, 0))^{\frac{1}{\delta_1}} \right].$$

Thus, from **Hypothesis 1.1.2** once again, we have

$$f(x, u) \geq \partial_u f(x, 0)u - c_{\delta_2} u^{1+\delta_2} \geq -c_\mu u,$$

where

$$c_\mu = \max \left(0, c_{\delta_2} (c_{\delta_1}^{-1} \max \partial_u f(x, 0))^{\frac{\delta_2}{\delta_1}} - \min \partial_u f(x, 0) \right).$$

From the proof of Lemma 2.2 in [26], we know that for $|x| \geq 1$

$$u(x, t_1) \geq \frac{ct_1 e^{-c_\mu t_1}}{t_1^{\frac{d}{2\alpha}+1} + |x|^{d+2\alpha}}, \quad (1.5.5)$$

where $c \in (0, 1)$ is a constant. For $|x| \leq 1$, we use Theorem 1.2 in [16] to have $u(x, t_1) \geq 2^{-1} \min u_+$. To get a subsolution, we choose

$$\underline{a} = \frac{ce^{-c_\mu t_1}}{2t_1^{\frac{d}{2\alpha}} \max \phi_1} \quad \text{and} \quad \underline{B} = \left(\frac{3}{2}\right)^{\frac{d+2\alpha}{2\alpha-\gamma} \delta_2} t_1^{-(\frac{d}{2\alpha}+1)\delta_2}. \quad (1.5.6)$$

Simple computations give :

$$- \text{ for } |x| \leq 1 : \underline{u}(x, 0) \leq \underline{a} \max \phi_1 = 2^{-1} ct_1^{-\frac{d}{2\alpha}} e^{-c_\mu t_1} \leq 2^{-1} \min u_+ \leq u(x, t_1),$$

$$- \text{ for } |x| \in (1, t_1^{\frac{1}{2\alpha}}), \text{ we have } |x|^{d+2\alpha} \leq t_1^{\frac{d}{2\alpha}+1} \text{ and using (1.5.5) :}$$

$$\underline{u}(x, 0) \leq \underline{a} \max \phi_1 = 2^{-1} ct_1^{-\frac{d}{2\alpha}} e^{-c_\mu t_1} \leq \frac{ct_1 e^{-c_\mu t_1}}{t_1^{\frac{d}{2\alpha}+1} + |x|^{d+2\alpha}} \leq u(x, t_1),$$

$$- \text{ for } |x| \geq t_1^{\frac{1}{2\alpha}}, \text{ we have } |x|^{d+2\alpha} \geq t_1^{\frac{d}{2\alpha}+1} \text{ and using (1.4.4) and (1.5.6) :}$$

$$\underline{u}(x, 0) \leq \frac{\underline{a} \max \phi_1}{\underline{b}(0)^{\frac{1}{\delta_2}} |x|^{d+2\alpha}} \leq \left(\frac{2}{3}\right)^{\frac{d+2\alpha}{2\alpha-\gamma} \delta_2} \frac{\underline{a} \max \phi_1}{\underline{B}^{\frac{1}{\delta_2}} |x|^{d+2\alpha}} = \frac{ct_1 e^{-c_\mu t_1}}{2|x|^{d+2\alpha}} \leq u(x, t_1).$$

Thus, we have $\underline{u}(\cdot, 0) \leq u(\cdot, t_1)$ in \mathbb{R}^d .

From the choice of t_1 done in (1.5.4), the constants \underline{a} and \underline{B} imposed in (1.5.6) satisfy the assumptions of Lemma 1.4.1. Consequently \underline{u} , defined in the same lemma, is a subsolution to (1.1.1) for $t > t_1$. By the maximum principle applied to (1.1.1), we have for all $x \in \mathbb{R}^d$ and $t \geq t_1$

$$\underline{u}(x, t - t_1) \leq u(x, t).$$

Finally, we define

$$\varepsilon = \frac{\underline{a} \min \phi_1}{2^{\frac{1}{\delta_2}}} \quad \text{and} \quad C_\varepsilon^{d+2\alpha} = e^{-|\lambda_1| t_1} \underline{B}^{-\frac{1}{\delta_2}},$$

and take x such that $|x| < C_\varepsilon e^{\frac{|\lambda_1|}{d+2\alpha} t}$. Using (1.4.4), we have for $t \geq t_1$ and $x \in \mathbb{R}^d$

$$u(x, t) > \frac{\underline{a} \min \phi_1}{(1 + \underline{B} e^{\delta_2 |\lambda_1| t_1} C_\varepsilon^{(d+2\alpha)\delta_2})^{\frac{1}{\delta_2}}} = \frac{\underline{a} \min \phi_1}{2^{\frac{1}{\delta_2}}} = \varepsilon, \quad (1.5.7)$$

which proves (1.5.3) for $t_\varepsilon = t_1$.

1.6 Proof of Theorem 1.1.4

Let u_+ be the unique bounded positive steady solution to (1.1.1). For all $\beta > 1$, the function βu_+ is a supersolution to (1.1.1). For any initial condition u_0 that satisfies the hypotheses of Theorem 1.1.4, the standard principle comparison applied to (1.1.1) gives for all $t \geq 0$ and all $x \in \mathbb{R}^d$

$$u(x, t) \leq \beta u_+(x).$$

The important part of Theorem 1.1.4 is to prove that there exist a constant $c_\beta > 0$ and a time $t_\beta > 0$ such that

$$\text{for all } t \geq t_\beta \text{ and for all } |x| \leq c_\beta e^{\frac{|\lambda_1|}{d+2\alpha}t}, \quad \beta^{-1}u_+(x) \leq u(x, t). \quad (1.6.1)$$

The proof, detailed later, is based on the fact that, for any constants $t > 0$ and $c > 0$, we can cover the ball of radius $ce^{\frac{|\lambda_1|}{d+2\alpha}t}$, centered at 0, by a finite number of balls with radius $M \in (0, ce^{\frac{|\lambda_1|}{d+2\alpha}t})$ large enough, in a sense explained later. Then, on each ball of radius M , we use the usual notations and known results recalled in what follows.

For any $\lambda > 0$, we consider the Cauchy problem

$$\begin{cases} \partial_t u_M + (-\Delta)^\alpha u_M = f(x, u_M), & x \in B_M, t > 0, \\ u_M(x, t) = 0, & x \in \mathbb{R}^d \setminus B_M, t > 0, \\ u_0^M(x, 0) = \lambda \mathbf{1}_{B_M}(x), & x \in \mathbb{R}^d. \end{cases} \quad (1.6.2)$$

The principal eigenvalue $\lambda_{M,1}$ of $(-\Delta)^\alpha - \partial_u f(x, 0)I$ in B_M is defined as the unique real number such that there exists a function $\phi_{M,1}$ satisfying

$$\begin{cases} (-\Delta)^\alpha \phi_{M,1} = \partial_u f(x, 0)\phi_{M,1} + \lambda_{M,1}\phi_{M,1}, & x \in B_M, t > 0, \\ \phi_{M,1}(x, t) = 0, & x \in \mathbb{R}^d \setminus B_M, t > 0, \\ \phi_{M,1} > 0, \quad \|\phi_{M,1}\|_\infty = 1. \end{cases}$$

In the sequel, for any $M > 0$, $u_{M,+}$ denotes the unique positive bounded steady solution to (1.6.2).

- **Result 1** : From Theorem 5.1 in [16], if $\lambda_{M,1} < 0$, then the solution u_M to (1.6.2) tends to $u_{M,+}$ as t goes to $+\infty$. In other words, for all $\beta_1 > 1$, there exists $t_{M,\beta_1} > 0$, that depends on M and β_1 , such that, for all $t \geq t_{M,\beta_1}$ and all $x \in B_M$,

$$\beta_1^{-1}u_{M,+}(x) \leq u_M(x, t) \leq \beta_1 u_{M,+}(x). \quad (1.6.3)$$

- **Result 2** : The function $M \mapsto \lambda_{M,1}$ is decreasing, and from Theorem 1.1 in [16], we have

$$\lim_{M \rightarrow +\infty} \lambda_{M,1} = \lambda_1 < 0.$$

- **Result 3** : Assume $M > 0$ is such that $\lambda_{M,1} < 0$. The function $M \mapsto u_{M,+}$ is non decreasing and bounded from above by u_+ . By standard elliptic estimates and by the uniqueness of u_+ , we have

$$\lim_{M \rightarrow +\infty} u_{M,+}(x) = u_+(x), \quad \text{on every compact sets.}$$

Consequently, for all $\beta_2 > 1$, there exists $M_{\beta_2} > 0$ such that

$$\text{for all } M \geq M_{\beta_2} \text{ and all } x \in B_M, \quad u_{M,+}(x) \geq \beta_2^{-1} u_+(x). \quad (1.6.4)$$

We can now prove (1.6.1). Let $\beta > 1$ and $\tilde{\beta} \in (1, \beta)$. In the sequel, $M_{\tilde{\beta}}$ is given by (1.6.4), with $\beta_2 = \tilde{\beta}$. Since $\lambda_1 < 0$, **Result 2** gives the existence of a constant $M > \max_{i \in \llbracket 1, d \rrbracket} (\ell_i, M_{\tilde{\beta}})$, where the constants ℓ_i , defined in (1.1.2), are linked to the period cell of $\partial_u f(x, 0)$, such that

$$\lambda_{M,1} < 0.$$

In what follows, the constants $\varepsilon > 0$, $C_\varepsilon > 0$ and $t_\varepsilon > 0$ are the one obtained in the second point of Theorem 1.1.3. We set $\tilde{t}_1 = \max\left(t_\varepsilon, \frac{d+2\alpha}{|\lambda_1|} \ln(MC_\varepsilon)\right) + 1$ and $\tilde{C}_\varepsilon = \frac{1}{2}(C_\varepsilon - Me^{-\frac{|\lambda_1|}{d+2\alpha}\tilde{t}_1}) > 0$, so that

$$M < C_\varepsilon e^{\frac{|\lambda_1|}{d+2\alpha}\tilde{t}_1} - \tilde{C}_\varepsilon e^{\frac{|\lambda_1|}{d+2\alpha}\tilde{t}_1} < C_\varepsilon e^{\frac{|\lambda_1|}{d+2\alpha}\tilde{t}_1}.$$

For t_{M,β_1} the time obtained in (1.6.3) with $\beta_1 = \beta\tilde{\beta}^{-1} > 1$, we define $t_\beta = \tilde{t}_1 + t_{M,\beta_1}$, and $c_\beta = \tilde{C}_\varepsilon e^{-\frac{|\lambda_1|}{d+2\alpha}t_{M,\beta_1}}$. Take $t \geq t_\beta$. Theorem 1.1.3 gives

$$u(x, t - t_{M,\beta_1}) > \varepsilon, \quad \text{for all } |x| < C_\varepsilon e^{\frac{|\lambda_1|}{d+2\alpha}(t - t_{M,\beta_1})}. \quad (1.6.5)$$

We cover the ball of radius $\tilde{C}_\varepsilon e^{\frac{|\lambda_1|}{d+2\alpha}(t - t_{M,\beta_1})}$ and centered at the origin by a finite number N of balls $B_M(z_j)$ of radius M , centered at points $z_j \in \mathbb{R}^d$. Since $M > \max_{i \in \llbracket 1, d \rrbracket} \ell_i$,

taking N larger if necessary, we can consider that, for all $j \in \llbracket 1, N \rrbracket$, $z_j \in \prod_{i=1}^d \ell_i \mathbb{Z}$.

Since $\partial_u f(x, 0)$ is periodic in each x_i -variable, the function v_j defined in $\mathbb{R}^d \times \mathbb{R}_+$ by

$$\text{for all } j \in \llbracket 1, N \rrbracket, \quad v_j(\cdot, \cdot) = u(\cdot - z_j, \cdot)$$

is the solution to (1.1.1) with initial datum equal to $u_0(\cdot - z_j)$ in \mathbb{R}^d . Using (1.6.5), we can apply the maximum principle to (1.6.2), to get for all $x \in B_M$,

$$v_j(x, t) \geq u_M(x, t_{M, \beta_1}), \quad (1.6.6)$$

where u_M is the solution to (1.6.2) with $\lambda = \varepsilon$.

From **Result 1** and **Result 3**, we have for all $x \in B_M$

$$u_M(x, t_{M, \beta_1}) \geq \tilde{\beta} \beta^{-1} u_{M,+}(x) \geq \beta^{-1} u_+(x). \quad (1.6.7)$$

Thus, for all $j \in \llbracket 1, N \rrbracket$, all $x \in B_M$, (1.6.6) and (1.6.7) lead to

$$v_j(x, t) \geq \beta^{-1} u_+(x).$$

Since $\bigcup_{j=1}^N B_M(z_j)$ covers the ball of radius $\tilde{C}_\varepsilon e^{\frac{|\lambda_1|}{d+2\alpha}(t-t_{M, \beta_1})}$, centered at 0, we have

$$u(x, t) \geq \beta^{-1} u_+(x), \quad \text{for all } |x| \leq \tilde{C}_\varepsilon e^{\frac{|\lambda_1|}{d+2\alpha}(t-t_{M, \beta_1})} = c_\beta e^{\frac{|\lambda_1|}{d+2\alpha}t}.$$

This is true for all $t \geq t_\beta$, which ends the proof.

1.7 Numerical simulations in space dimension 2

The aim of this section is to get further information about the constant c_λ that appears in Theorem 1.1.3, and more precisely to understand its dependence on the initial condition u_0 . Indeed, for any direction $e \in S^{d-1}$, is there a universal function $C(e) > 0$, such that, for all $\lambda \in (0, \min u_+)$, the family of functions $x_\lambda(t)$ defined by $u(x_\lambda(t), t) = \lambda$, satisfies, for large times,

$$|x_\lambda(t)| \underset{t \rightarrow +\infty}{\sim} C(e) e^{\frac{|\lambda_1|}{d+2\alpha}t} ? \quad (1.7.1)$$

In other words, is there a universal shape of the level sets of the solution to problem (1.1.1), may be depending on the decay at infinity of the initial condition?

We will see that the result is far from obvious, as will already be clear from the study of the homogeneous model. We thank Professor H. Berestycki for raising this question.

Let us therefore investigate the homogeneous model in \mathbb{R}^2 :

$$\begin{cases} \partial_t u + (-\Delta)^\alpha u = u - u^2, & \mathbb{R}^2, t > 0, \\ u(x, 0) = u_0(x), & x \in \mathbb{R}^2, \end{cases} \quad (1.7.2)$$

where u_0 is a piecewise continuous, nonnegative and non identically equal to 0 function, and we carry out numerical computations. Our simulations tend to suggest that there

is symmetrisation of the level sets as soon as $|x|^{2+2\alpha} u_0(x)$ tends to 0 as $|x|$ tends to infinity.

Let us describe the numerical procedure. The solution to (1.7.2) will be denoted by $T^t u_0$, where T^t is the semi flow associated with (1.7.2). A natural approach to estimate $T^t u_0$ is based on the decomposition of the Cauchy problem (1.7.2) into simpler subproblems that are explicitly solvable. The most popular and widely used is the Strang splitting, explained below.

We split problem (1.7.2) into two evolution problems with explicit solutions and we treat them individually using specialised numerical algorithms. The two subproblems under consideration are the following.

- The first step of the splitting treats the diffusive part of (1.7.2), which is

$$\begin{cases} \partial_t v + (-\Delta)^\alpha v = 0, & \mathbb{R}^2, t > 0, \\ v(x, 0) = v_0(x), & x \in \mathbb{R}^2, \end{cases} \quad (1.7.3)$$

for any function $v_0 \in \mathcal{C}^{1,\alpha}(\mathbb{R}^2) \cap L^\infty(\mathbb{R}^2)$. The solution to (1.7.3) is denoted by $X^t v_0$ and is explicitly given, for $x \in \mathbb{R}^2$ and $t > 0$, by

$$X^t v_0(x, t) = \mathcal{F}^{-1} \left(\xi \mapsto e^{-|\xi|^{2\alpha} t} \mathcal{F}(v_0)(\xi) \right) (x),$$

where \mathcal{F} and \mathcal{F}^{-1} are respectively the Fourier transform and the inverse Fourier transform in the space variable. The solution $X^t v_0$ is computed with Fast Fourier Transform techniques.

- The nonlinear part of (1.7.2) appears in the second step of the splitting, and is given by the ordinary differential equation :

$$\begin{cases} \partial_t w = w - w^2, & \mathbb{R}^2, t > 0, \\ w(x, 0) = w_0(x), & x \in \mathbb{R}^2, \end{cases} \quad (1.7.4)$$

for any function $w_0 : \mathbb{R}^2 \rightarrow \mathbb{R}$. The solution, denoted by $Y^t w_0$, has the explicit expression

$$Y^t w_0(x, t) = \frac{w_0(x)}{w_0(x) + (1 - w_0(x))e^{-t}}.$$

This does not require any numerical approximation.

The two Strang approximation formulas are given in [82], for $t \geq 0$, by

$$S_1^t u_0 = X^{\frac{t}{2}} Y^t X^{\frac{t}{2}} u_0, \quad S_2^t u_0 = Y^{\frac{t}{2}} X^t Y^{\frac{t}{2}} u_0. \quad (1.7.5)$$

The study of the convergence of these approximations to $T^t u_0$ is not the aim of this work; general results are given for example in [52]. In our case, both approximations S_1 and S_2 lead to the same results.

The following numerical computations are done in the domain $(-2000, 2000) \times (-2000, 2000)$. We investigate different initial conditions and distinguish the cases $\alpha = 1$ and $\alpha \in (0, 1)$, for which the fundamental solution p_α has a completely different decay at infinity. Indeed, recall that p_α satisfies, for all $x \in \mathbb{R}^2$ and $t > 0$:

$$\begin{cases} p_\alpha(x, t) = \frac{e^{-\frac{|x|^2}{4t}}}{4\pi t}, & \text{if } \alpha = 1, \\ \frac{B^{-1}t}{t^{\frac{1}{\alpha}+1} + |x|^{2+2\alpha}} \leq p_\alpha(x, t) \leq \frac{Bt}{t^{\frac{1}{\alpha}+1} + |x|^{2+2\alpha}}, & \text{if } \alpha \in (0, 1). \end{cases}$$

First, we treat a spherical initial datum u_{01} , for which the level sets are also spherical. This gives an indication of the validity of our numerical procedure. Then, we consider four non symmetric initial conditions u_{0i} , for $i \in \llbracket 2, 5 \rrbracket$, all with level set of value 0,5 given by Figure 1.1, but with different decays at infinity :

- u_{02} compactly supported,
- u_{03} decaying strictly faster than the heat kernel p_α ,
- u_{04} decaying exactly like the heat kernel p_α ,
- u_{05} decaying slower than the heat kernel p_α .

The explicit expression of u_{0i} , for $i \in \llbracket 2, 5 \rrbracket$, will be given later.

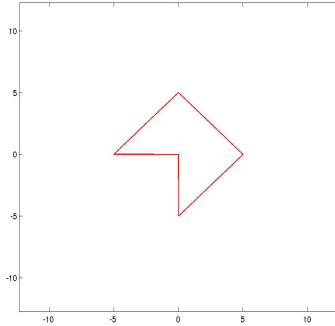

Figure 1.1: Shape of the level set of value 0,5 of the initial data.

Let us start with the following spherical initial condition :

$$u_{01}(x_1, x_2) = e^{-\frac{1}{25}(|x_1|^2 + |x_2|^2)},$$

for which the level sets are also spherical. The shape of the level sets of the solution to (1.7.2), with u_{01} as initial datum, is given on Figure 1.2 for times smaller than 15. Surprisingly enough, such times are large enough to have a correct approximation of the speed of propagation.

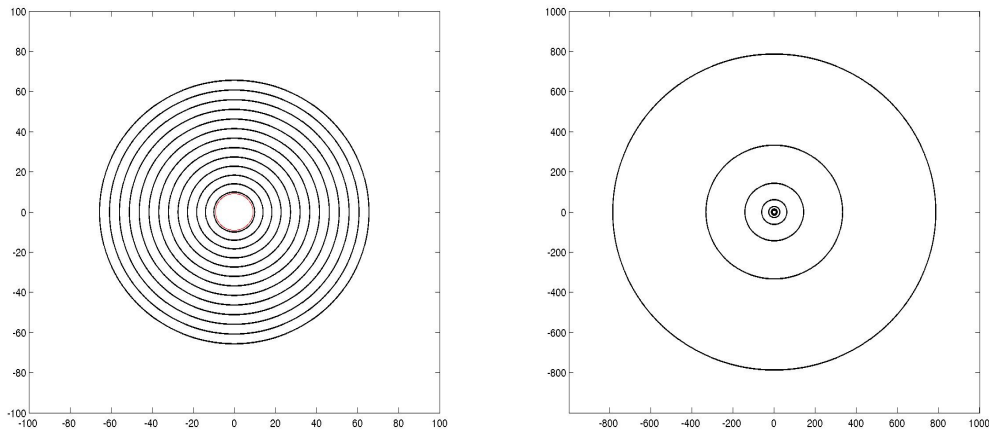

Figure 1.2: Level sets of value 0,5 of the solution u to (1.7.2), starting from u_{01} , at successive times $t = 0, 2.5, 5, \dots, 30$, for $\alpha = 1$ on the left and at successive times $t = 0, 2.5, 5, \dots, 15$, for $\alpha = 0,5$ on the right.

For $\alpha = 1$, in any directions, the distance between two successive level sets is constant as time grows, whereas for $\alpha = \frac{1}{2}$, this distance becomes larger with time, which illustrates the infinite speed of propagation. More precisely, the level sets displayed on Figure 1.2 give, let us say for $n \in \llbracket 1, 7 \rrbracket$, sequences ρ_n and $t_n = 2, 5n$, that satisfy, for any $\theta \in [0, 2\pi]$,

$$u(\rho_n \cos(\theta), \rho_n \sin(\theta), t_n) = \frac{1}{2}.$$

The left side of Figure 1.2 gives, for $n \in \llbracket 2, 6 \rrbracket$, $\rho_{n+1} - \rho_n$ close to 5, which corresponds, according to our time scale, to the expected KPP velocity equal to 2. The right side of this figure gives, for $n \in \llbracket 3, 6 \rrbracket$, $\frac{\rho_{n+1}}{\rho_n}$ close to 2,3, which corresponds to the expected value $e^{\frac{2,5}{2+2\alpha}}$ for $\alpha = \frac{1}{2}$. This analysis enables us to take any time $t \geq 10$ as stopping criterion, when considering non symmetric initial conditions.

From now on, we consider non symmetric initial conditions with level set of value 0,5 displayed on Figure 1.1. We begin with the following compactly supported initial condition :

$$u_{02}(x_1, x_2) = \begin{cases} e^{-\frac{1}{25}(|x_1|+|x_2|)^2}, & \text{if } (x_1 > 0 \text{ or } x_2 > 0) \text{ and } |x_1| + |x_2| \leq 20, \\ 0, & \text{otherwise.} \end{cases}$$

For $\alpha = 1$, the shape of the level sets corresponds to the one described by Jones in [57], and reproved by Berestycki in Theorem 2.9 of [10], where the proof is flexible and does not depend on the nonlinearity. This result shows an asymptotic symmetrisation of the solution to (1.7.2). This means that, in the limit of $t \rightarrow +\infty$, the level sets, once rescaled to be at finite distance, have their normal at every point going through the

same fixed point. It is also known (see [77]) that the level sets may have perturbations of order one, that survive for all times. This result is illustrated by Figure 1.3.

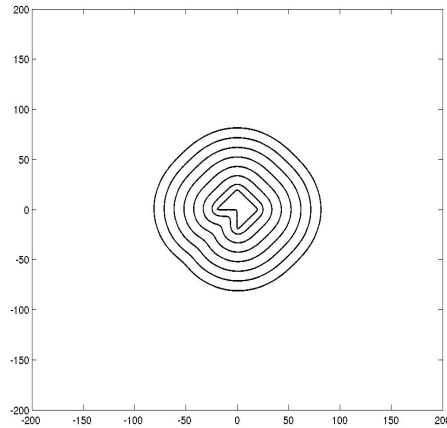

Figure 1.3: Level sets of value 0,5 of the solution u to (1.7.2), with $\alpha = 1$, starting from u_{02} , at successive times $t = 0, 2.5, 5, \dots, 17.5$.

For $\alpha \in (0, 1)$, the proof of Berestycki does not apply (at least right away), but the result of symmetrisation, in the sense of Jones in [57], seems to be true, as illustrated by Figure 1.4. Note that, as expected, the smaller α is, the greater the speed of propagation is.

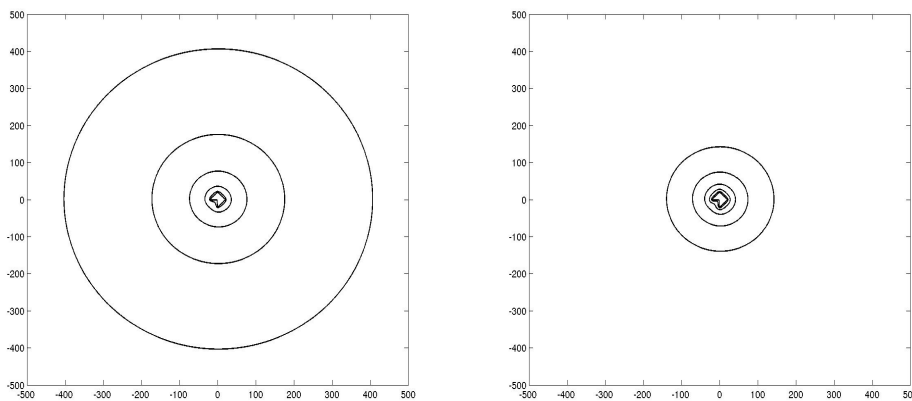

Figure 1.4: Level sets of value 0,5 of the solution u to (1.7.2), starting from u_{02} , with $\alpha = 0,5$ on the left and $\alpha = 0,8$ on the right, at successive times $t = 0, 2.5, 5, \dots, 12.5$.

Before solving (1.7.2) with other non symmetric initial conditions, we want to illustrate the method used to prove Theorem 1.1.3. Indeed, recall that, in the formal analysis done in section 1.2 for $\alpha \in (0, 1)$, we rescale the space variable and neglect the

diffusive term. This reveals that, the diffusive term $(-\Delta)^\alpha u$ in (1.7.2) only plays a role for small times, having a regularisation effect on the initial condition. Thus, after a time $t_0 > 0$, the diffusion seems not to have an impact on the solution to (1.7.2). The right side of Figure 1.5 compares the level sets of value 0,5 of the solution u to (1.7.2), starting from u_{02} , with those of the solution to the ordinary differential equation

$$\partial_t v = v - v^2, \quad x \in \mathbb{R}^2, \quad t > t_0, \quad (1.7.6)$$

starting from $u(\cdot, t_0)$, with $t_0 = 8$. The similarity between the level sets of these two solutions is a good indication that the diffusive term seems not to act after a time $t_0 > 0$, time from which the ordinary differential equation (1.7.6) gives the behaviour of the solution. The left side of Figure 1.5 compares the level sets of the same solutions, but in the case $\alpha = 1$. In this case, the level sets of the solution to (1.7.6), that starts at $u(\cdot, 8)$, are expected to grow like \sqrt{t} . This confirms that the method set up for $\alpha \in (0, 1)$, does not apply to standard diffusion ($\alpha = 1$), for which the term $-\Delta u$ in (1.7.2) acts at any time.

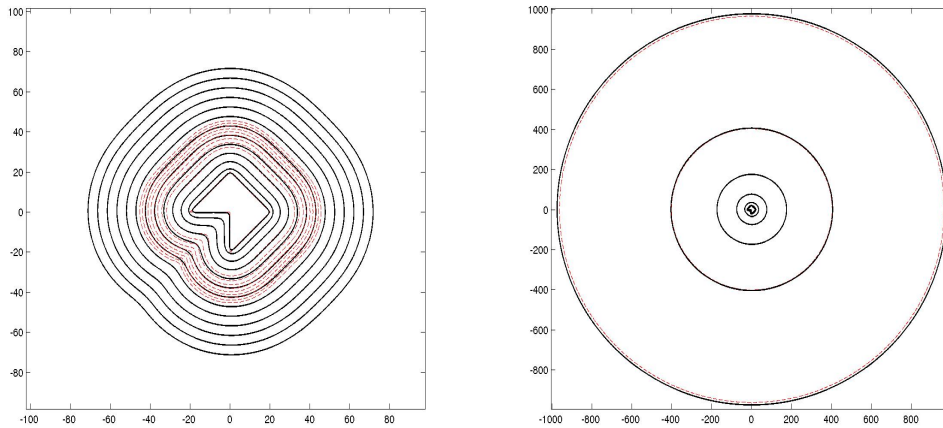

Figure 1.5: Level sets of value 0,5 of the solution u to (1.7.2), starting from u_{02} (in black) and of the solution to (1.7.6) starting at $u(\cdot, 8)$ (in red dotted lines), with $\alpha = 1$, at successive times $t = 0, 2.5, 5, \dots, 30$ on the left and $\alpha = 0, 5$, at successive times $t = 0, 2.5, 5, \dots, 15$ on the right.

We now consider the initial datum u_{03} , that decays faster than the heat kernel p_α :

$$u_{03}(x_1, x_2) = \begin{cases} \begin{cases} e^{-\frac{1}{25}(|x_1|+|x_2|)^3}, & \text{if } x_1 > 0 \text{ or } x_2 > 0, \\ 0, & \text{otherwise,} \end{cases} & \text{if } \alpha = 1, \\ \begin{cases} \left(1 + \frac{(|x_1|+|x_2|)^4}{25}\right)^{-1}, & \text{if } x_1 > 0 \text{ or } x_2 > 0, \\ 0, & \text{otherwise,} \end{cases} & \text{if } \alpha \in (0, 1). \end{cases}$$

Figure 1.6 shows that in both cases $\alpha = 1$ and $\alpha = \frac{1}{2}$, we have symmetrisation of the level sets.

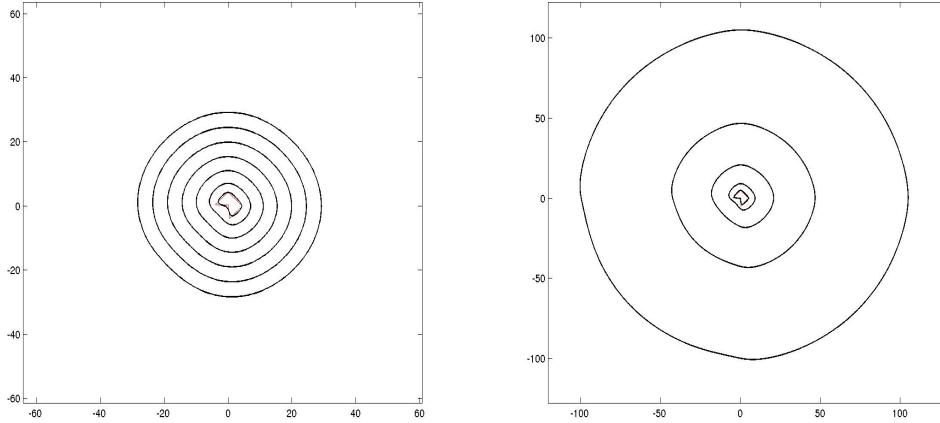

Figure 1.6: Level sets of value 0, 5 of the solution u to (1.7.2), starting from u_{03} , with $\alpha = 1$ on the left and $\alpha = 0, 5$ on the right, at successive times $t = 0, 2.5, 5, \dots, 15$.

This reveals that, for any $\alpha \in (0, 1)$ and any initial conditions decaying faster than the heat kernel p_α , there might exist a universal function $C(e) > 0$, depending on a direction $e \in S^{d-1}$, that satisfies (1.7.1), that is to say such that

$$|x_\lambda(t)| \underset{t \rightarrow +\infty}{\sim} C(e) e^{\frac{|\lambda_1|}{d+2\alpha} t},$$

where $u(x_\lambda(t), t) = \lambda$, for all $\lambda \in (0, \min u_+)$.

The non symmetric initial datum u_{04} , that we now consider, decays like the heat kernel p_α .

- For $\alpha = 1$, u_{04} is defined by

$$u_{04}(x_1, x_2) = \begin{cases} e^{-\frac{1}{25}(|x_1|+|x_2|)^2}, & \text{if } x_1 > 0 \text{ or } x_2 > 0, \\ 0, & \text{otherwise.} \end{cases}$$

It is well known (see [61] for instance) that the level sets of the solution u to (1.7.2) move at the finite speed 2, at large times, which is readable on Figure 1.7.

- For $\alpha \in (0, 1)$, u_{04} is defined by

$$\begin{cases} \left(1 + \frac{(|x_1|+|x_2|)^{2+2\alpha}}{25}\right)^{-1}, & \text{if } x_1 > 0 \text{ or } x_2 > 0, \\ 0, & \text{otherwise.} \end{cases}$$

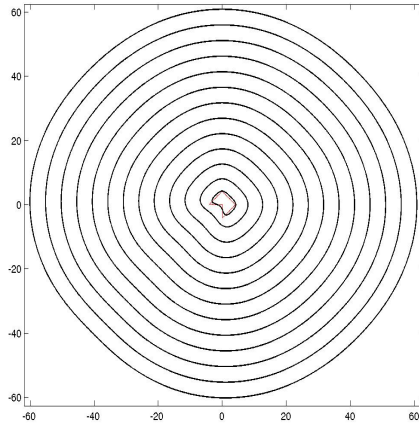

Figure 1.7: Level sets of value 0, 5 of the solution u to (1.7.2) with $\alpha = 1$, starting from u_{04} , at successive times $t = 0$ in red and $t = 2.5, 5, \dots, 20$ in black.

From Theorem 1.1.5, we know that the propagation is exponential in time with an exponent equal to $\frac{1}{d+2\alpha}$.

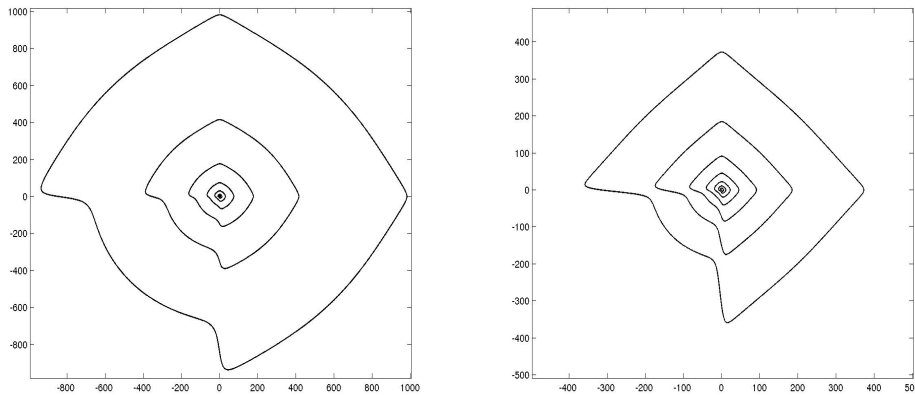

Figure 1.8: Level sets of value 0, 5 of the solution u to (1.7.2), starting from u_{04} , at successive times $t = 0, 2.5, 5, \dots, 15$, for $\alpha = 0, 5$ on the left and $\alpha = 0, 8$ on the right.

On Figure 1.8, we can see, in both cases $\alpha = 0, 5$ and $\alpha = 0, 8$, an homogeneous dilation of the level sets as soon as t is greater than 10. Indeed, the structure of the initial datum seems to be preserved as time grows. This shows that there exists no universal function $C(e) > 0$ that satisfies (1.7.1) for such initial conditions.

Note that the spherical part obtained in both cases $\alpha = 0, 5$ and $\alpha = 0, 8$, in the left lower quadrant, is due to the initial condition being equal to 0 in this part

of the plane. For any time $t > 0$, the solution $u(\cdot, t)$ behaves in this quadrant like the symmetric function p_α , that is to say, it decays like $|x|^{-(2+2\alpha)}$ for large values of $|x|$.

Finally, we consider :

$$u_{05}(x_1, x_2) = \begin{cases} \left(1 + \frac{(|x_1|+|x_2|)^2}{25}\right)^{-1}, & \text{if } x_1 > 0 \text{ or } x_2 > 0, \\ 0, & \text{otherwise,} \end{cases}$$

that decays slower than the fundamental solution p_α in both cases $\alpha = 1$ and $\alpha \in (0, 1)$. The results are given on Figure 1.9.

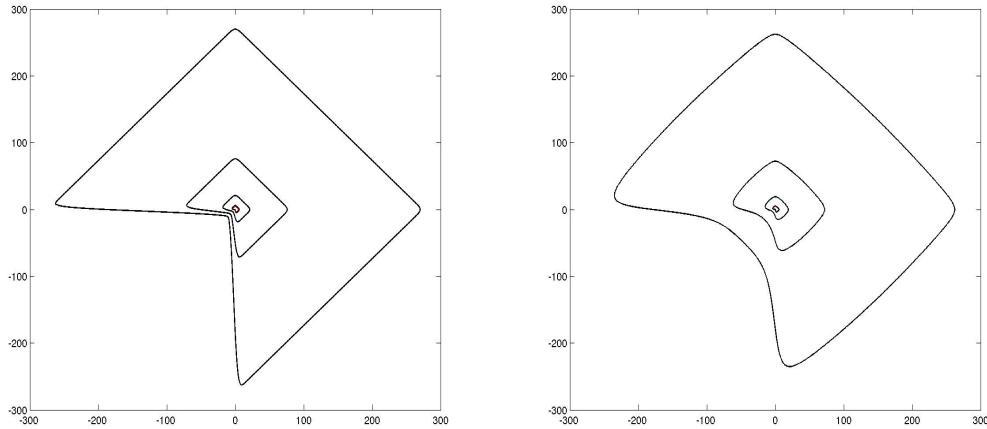

Figure 1.9: Level sets of value 0,5 of the solution u to (1.7.2), starting from u_{05} , at successive times $t = 0, 2.5, 5, 7.5$, for $\alpha = 1$ on the left and $\alpha = 0, 5$ on the right.

For $\alpha = 1$, from [51], we know that the level sets of the solution u to (1.7.2), starting from u_{05} , move exponentially fast in time, with an exponent equal to $\frac{1}{4}$, at large times. The left side of Figure 1.9 shows that the initial structure of u_{05} is preserved as time grows. If $x = (x_1, x_2)$ belongs to the quadrant where x_1 and x_2 are both negative, then $u_{05}(x) = 0$, and consequently, at any time $t > 0$, the solution $u(\cdot, t)$ decays like $e^{-\frac{|x|^2}{4t}}$, for large values of $|x|$. This explains the linear propagation in time in this quadrant in the left side of Figure 1.9. On the contrary, if $x = (x_1, x_2)$ is such that $x_1 > 0$ or $x_2 > 0$, then the speed of propagation is infinite as rigorously proved in [51].

For $\alpha = \frac{1}{2}$, Theorem 1.1.5 does not apply with u_{05} as initial condition. However, it is natural to think that the initial structure of u_{05} is preserved as time grows. Moreover, we may expect the speed of propagation to be exponential in time with exponent equal to $\frac{1}{2+2\alpha}$, in the quadrant where $x_1 < 0$ and $x_2 < 0$, and equal to $\frac{1}{4}$ in the three other quadrants. This intuition is illustrated by the right side of Figure 1.9. Indeed, the

distance between two successive level sets is close to 2,8 in the bottom left quadrant, that corresponds to an exponential propagation in time with exponent $\frac{1}{2+2\alpha}$, whereas this distance is close to 3,5 in the other quadrants, that corresponds to an exponential propagation in time with exponent $\frac{1}{4}$.

Chapter 2

Monotone systems

2.1 Introduction

In this chapter, we focus on the large time behaviour of the solution $u = (u_i)_{i=1}^m$, for $m \in \mathbb{N}^*$, to the fractional reaction-diffusion system :

$$\begin{cases} \partial_t u_i + (-\Delta)^{\alpha_i} u_i = f_i(u), & x \in \mathbb{R}^d, t > 0, \\ u_i(x, 0) = u_{0i}(x), & x \in \mathbb{R}^d. \end{cases} \quad (2.1.1)$$

We consider that at least one equation has a fractional diffusive term, that is to say

$$\text{for all } i \in \llbracket 1, m \rrbracket, \quad \alpha_i \in (0, 1] \quad \text{and} \quad \alpha := \min_{\llbracket 1, m \rrbracket} \alpha_i < 1.$$

As general assumptions, for all $i \in \llbracket 1, m \rrbracket$, we impose the initial condition u_{0i} to be nonnegative, non identically equal to 0, continuous and to satisfy

$$u_{0i}(x) = O(|x|^{-(d+2\alpha_i)}) \quad \text{as } |x| \rightarrow +\infty. \quad (2.1.2)$$

We also assume that, for all $i \in \llbracket 1, m \rrbracket$, the function f_i satisfies $f_i(0) = 0$ and that system (2.1.1) is cooperative, which means :

$$f_i \in C^1(\mathbb{R}^m) \quad \text{and} \quad \partial_j f_i > 0, \quad \text{on } \mathbb{R}^m, \quad \text{for } j \in \llbracket 1, m \rrbracket, j \neq i. \quad (2.1.3)$$

The aim of this chapter is to understand the time asymptotic location of the level sets of the solution to (2.1.1), using the method described in the introduction of the thesis. We prove that the speed of propagation is exponential in time, with a precise exponent depending on the smallest index $\alpha = \min_{i \in \llbracket 1, m \rrbracket} \alpha_i$ and on the principal eigenvalue of the matrix $DF(0)$ where $F = (f_i)_{i=1}^m$. This exponent does not depend on the direction of propagation.

In what follows, and without loss of generality, we suppose that $\alpha_{i+1} \leq \alpha_i$ for all $i \in \llbracket 1, m-1 \rrbracket$. Before stating the main results, we need some additional hypotheses on the nonlinearities f_i , for all $i \in \llbracket 1, m \rrbracket$.

- (H1) The principal eigenvalue λ_1 of the matrix $DF(0)$ is positive,
- (H2) There exists $\Lambda > 1$ such that, for all $s = (s_i)_{i=1}^m \in \mathbb{R}_+^m$ satisfying $|s| \geq \Lambda$, we have $f_i(s) \leq 0$,
- (H3) For all $s = (s_i)_{i=1}^m \in \mathbb{R}_+^m$ satisfying $|s| \leq \Lambda$, $Df_i(0)s - f_i(s) \geq c_{\delta_1} s_i^{1+\delta_1}$,
- (H4) For all $s = (s_i)_{i=1}^m \in \mathbb{R}_+^m$ satisfying $|s| \leq \Lambda$, $Df_i(0)s - f_i(s) \leq c_{\delta_2} |s|^{1+\delta_2}$,
- (H5) $F = (f_i)_{i=1}^m$ is globally Lipschitz on \mathbb{R}^m ,

where the constants c_{δ_1} and c_{δ_2} are positive and independent of $i \in \llbracket 1, m \rrbracket$, and for all $j \in \{1, 2\}$

$$\delta_j \geq \frac{2}{d + 2\alpha}.$$

This lower bound on δ_1 and δ_2 is a technical assumption to make the supersolution and subsolution to (2.1.1), we construct, to be regular enough.

Remark 2.1.1. From hypothesis (H2), we deduce that the positive vector $M = \Lambda \mathbf{1}$, where $\mathbf{1}$ is the vector of size m with all entries equal to 1, is a supersolution to (2.1.1), if the initial condition $u_0 = (u_{0i})_{i=1}^m$ is smaller than M .

Before going further on, let us state at least one example of nonlinearity F satisfying all the assumptions (2.1.3) and (H1) to (H5). Let $A = (a_{ij})_{i,j=1}^m$ be a matrix, with negative non diagonal entries and with positive principal eigenvalue. For a constant $\Lambda > 1$, for all $i \in \llbracket 1, m \rrbracket$ and all $s \in \mathbb{R}^m$, we define

$$f_i(s) = As - \phi_i(s_i),$$

where

$$\phi_i(s_i) = \begin{cases} s_i |s_i|^\delta, & \text{if } |s_i| \leq \Lambda - 1, \\ \chi(s_i), & \text{if } \Lambda - 1 \leq |s_i| \leq \Lambda, \\ a_{ii} |s_i|, & \text{if } |s_i| \geq \Lambda, \end{cases}$$

with $\delta \geq \frac{2}{d+2\alpha}$, and χ a smooth function defined in \mathbb{R} , chosen so that $\phi_i \in \mathcal{C}^1(\mathbb{R})$, which implies $f_i \in \mathcal{C}^1(\mathbb{R}^m)$. These choices easily ensure (2.1.3), (H1) and (H5) since $DF(0) = A$. Moreover, for all $s \in \mathbb{R}_+^m$ such that $|s| \geq \Lambda$, we have

$$f_i(s) = \sum_{j=1}^m a_{ij} s_j - a_{ii} s_i \leq 0,$$

from the choice of A , which proves that (H2) is satisfied. The assumptions (H3) and (H4) are easily fulfilled taking $\delta_1 = \delta_2 = \delta$ and

$$c_{\delta_1} = \min \left(\min_{\tilde{s} \in \mathbb{R}, \Lambda-1 \leq |\tilde{s}| \leq \Lambda} \frac{\chi(\tilde{s})}{\Lambda^{1+\delta}}, 1 \right), \quad c_{\delta_2} = \max \left(\max_{\frac{\Lambda-1}{2} \leq |\tilde{s}| \leq \Lambda} \frac{\chi(\tilde{s})}{(\Lambda-1)^{1+\delta}}, 1 \right).$$

We are now in a position to state our main theorem. We consider the Banach space $C_0(\mathbb{R}^d)$, with the $L^\infty(\mathbb{R}^d)$ norm and we set $D_0(A_i)$ the domain of the operator $A_i = (-\Delta)^{\alpha_i}$ in $C_0(\mathbb{R}^d)$. In what follows, we assume that, for all $i \in \llbracket 1, m \rrbracket$, the initial condition u_{0i} is in $D_0(A_i)$. The following theorem proves that the solution u to (2.1.1) move exponentially fast in time with an exponent equal to $\frac{\lambda_1}{d+2\alpha}$, where λ_1 is the principal eigenvalue of $DF(0)$ and $\alpha = \min_{i \in \llbracket 1, m \rrbracket} \alpha_i$.

Theorem 2.1.2. *Let $d \geq 1$ and assume that $F = (f_i)_{i=1}^m$ satisfies (2.1.3), (H1), (H2), (H3), (H4) and (H5). Let u be the solution to (2.1.1) with $u_0 = (u_{0i})_{i=1}^m$ such that for all $i \in \llbracket 1, m \rrbracket$, u_{0i} is nonnegative, non identically equal to 0, continuous and satisfies (2.1.2). Then, there exists $\tau > 0$ large enough such that, for all $i \in \llbracket 1, m \rrbracket$, the following two facts are satisfied :*

a) *For every $\mu_i > 0$, there exists a constant $c > 0$ such that,*

$$u_i(x, t) < \mu_i, \quad \text{for all } t \geq \tau \text{ and } |x| > ce^{\frac{\lambda_1}{d+2\alpha}t}.$$

b) *There exist constants $\varepsilon_i > 0$ and $C > 0$ such that,*

$$u_i(x, t) > \varepsilon_i, \quad \text{for all } t \geq \tau \text{ and } |x| < Ce^{\frac{\lambda_1}{d+2\alpha}t}.$$

This theorem only gives the location of the level sets of small values. The convergence of the solution to (2.1.1) to the stationary state is proved in [85].

This chapter is dedicated to the proof of Theorem 2.1.2. First, in sections 2.2 and 2.3, we present some preliminaries in which we prove the existence and uniqueness of mild solutions for cooperative systems. We also state a comparison principle for this type of solutions. The results established by Cabré and Roquejoffre in [26] are easily adaptable to our system (2.1.1), that is why we have chosen to adopt this framework. We extend the principle comparison to classical solutions that have a particular decay at infinity. In section 2.4, we prove that our solution has the correct decay. This prove Step 1 of the method presented in the introduction of the thesis. A more original - and involved - part is to set an algebraically lower bound for the solution to (2.1.1), which is done in section 2.5 and corresponds to Step 3 of the method described in B.1.. The proof of Theorem 2.1.2 relies on the construction of explicit classical supersolutions and subsolutions, as set in Step 2 and Step 4 of the method. The computations are inspired from the results of Chapter 1. This is done in section 2.6.

2.2 Mild solutions

In order to state the existence of a unique solution of the system (2.1.1), we consider a Banach space of functions X and $G : [0, +\infty) \times X^m \rightarrow X^m$, $G = (G_i(u, t))_{i=1}^m$ a function that satisfies, for all $i \in \llbracket 1, m \rrbracket$,

$$\begin{aligned} G_i &\in C^1(X^m \times [0, +\infty); X), \\ G_i(\cdot, t) &\text{ is globally Lipschitz in } X^m \text{ uniformly in } t \geq 0, \end{aligned} \tag{2.2.1}$$

where X^m is the product space endowed with the norm $\|u\|_{X^m} = \sum_{i=1}^m \|u_i\|$, where $\|\cdot\|$ denotes the norm on X .

We are interested in the nonlinear problem

$$\begin{cases} \partial_t u + Lu &= G(u, t), & t > 0, x \in \mathbb{R}^d, \\ u(x, 0) &= u_0(x), & x \in \mathbb{R}^d, \end{cases} \quad (2.2.2)$$

where $L = \text{diag}((-\Delta)^{\alpha_1}, \dots, (-\Delta)^{\alpha_m})$, $u = (u_i)_{i=1}^m$ and $u_0 \in X^m$.

As in [26], we define the map $N_{u_0} : C([0, T]; X)^m \rightarrow C([0, T]; X)^m$ by

$$N_{u_0}(u)(t) := \mathbb{T}_t u_0 + \int_0^t \mathbb{T}_{t-s} G(u(s), s) ds,$$

where $\mathbb{T}_t = \text{diag}(T_{t,1}, \dots, T_{t,m})$, and, for all $i \in [1, m]$, $T_{t,i} w = p_{\alpha_i}(\cdot, t) \star w$.

Adapting the computations given in section 2 of [26] to the product space X^m , we can prove that there exists $u \in C([0, T]; X)^m$ such that

$$u = \lim_{i \rightarrow +\infty} (N_{u_0})^i(u^0),$$

where $u^0(t) = \mathbb{T}_t u_0$. The limit u is the unique fixed point of N_{u_0} . In what follows, we prove that u is the unique mild solution of (2.2.2).

Given any $0 < T < T'$, by uniqueness, the mild solution in $(0, T')$ must coincide in $(0, T)$ with the mild solution defined in $(0, T)$. Thus, under assumption (2.2.1) on the source term G , the mild solution to (2.2.2) extends uniquely to all $t \in [0, +\infty)$, i.e., it is global in time.

Let $u = (u_i)_{i=1}^m$ be the unique mild solution of (2.2.2). We define

$$H_i(w, t) = G_i(u_1, \dots, u_{i-1}, w, u_{i+1}, \dots, u_m, t),$$

so that

$$\begin{aligned} H_i &\in C^1(X \times [0, +\infty); X), \\ H_i(\cdot, t) &\text{ is globally Lipschitz in } X \text{ uniformly in } t \geq 0. \end{aligned} \quad (2.2.3)$$

Consider the problem

$$\begin{cases} \partial_t w_i + (-\Delta)^{\alpha_i} w_i &= H_i(w_i, t), & x \in \mathbb{R}^d, t > 0, \\ w_i(x, 0) &= u_{0i}(x), & x \in \mathbb{R}^d. \end{cases} \quad (2.2.4)$$

Following the computations of section 2.3 in [26], we conclude that, for any $T > 0$, this problem has a unique mild solution in $C([0, T]; X)$, given by $w_i = u_i$. Thus, if the initial datum belongs to the domain $D(A_i)$ in X of $A_i = (-\Delta)^{\alpha_i}$, we have further regularity in t of the mild solution u_i , that we will denote by $u_i(t)$ in the sequel. Under hypothesis (2.2.3), the mild solution u_i of (2.2.4) satisfies

$$u_i \in C^1([0, T]; X) \quad \text{and,} \quad \text{if } u_{0i} \in D(A_i), \quad u_i([0, T]) \subset D(A_i), \quad (2.2.5)$$

and is a classical solution, i.e., a solution satisfying (2.2.4) pointwise for all $t \in (0, T)$. Doing the same procedure for all $i \in \llbracket 1, m \rrbracket$ and for all $T > 0$, we conclude that $u = (u_i)_{i=1}^m$ is a global in time classical solution to (2.2.2).

Remark 2.2.1. If u is the solution to system (2.2.2) with $u_0 \in X^m$, and G satisfies (2.2.1), then for any $a \in \mathbb{R}$, $\tilde{u}(t) = e^{at}u(t)$ is the mild solution to (2.2.2) with $u_0 \in X^m$, and G replaced by \tilde{G} defined on $X^m \times [0, +\infty)$ by $\tilde{G}(\tilde{u}, t) = a\tilde{u} + e^{at}G(e^{-at}\tilde{u}, t)$. This fact is proved in the same way as in [26].

From now on, we consider the Banach space $X = C_0(\mathbb{R}^d)$ and set, for all $i \in \llbracket 1, m \rrbracket$,

$$G_i(u, t)(x) := f_i(u(x)),$$

so that G_i satisfies (2.2.1). Since $f_i \in C^1(\mathbb{R}^m)$ and $f_i(0) = 0$, the map

$$u \in C_0(\mathbb{R}^d)^m \mapsto f_i(u) \in C_0(\mathbb{R}^d)$$

is continuously differentiable. Thus, by the previous considerations and (H5), there is a unique mild solution u to (2.1.1), starting from $u_0 \in X^m$. If the initial datum u_0 belongs to $\prod_{i=1}^m D_0(A_i)$, where $D_0(A_i)$ is the domain of $A_i = (-\Delta)^{\alpha_i}$ in $C_0(\mathbb{R}^d)$, then the mild solution u satisfies (2.2.5) for all $T > 0$, and is a global in time classical solution.

2.3 Comparison principles

2.3.1 Comparison principle for mild solutions

Before proving Theorem 2.1.2, we need to establish a comparison principle for mild solutions in the Banach space $X = C_0(\mathbb{R}^d)$.

Theorem 2.3.1. *For every $j \in \{1, 2\}$, set $F^j = (f_i^j)_{i=1}^m$ where, for all $i \in \llbracket 1, m \rrbracket$, f_i^j is $C^1(\mathbb{R}^m)$, satisfies (2.1.3) and is globally Lipschitz. Let $u^j = (u_i^j)_{i=1}^m$ be the mild solution to*

$$\partial_t u^j + Lu^j = F^j(u^j),$$

with initial condition $u^j(\cdot, 0) \in X^m$. If, for all $i \in \llbracket 1, m \rrbracket$, $f_i^1 \leq f_i^2$ in \mathbb{R}^m and $u_i^1(\cdot, 0) \leq u_i^2(\cdot, 0)$ in \mathbb{R}^d , then

$$u_i^1(x, t) \leq u_i^2(x, t) \quad \text{for all } (x, t) \in \mathbb{R}^d \times [0, +\infty).$$

Proof : We set $a = \max_{i \in \llbracket 1, m \rrbracket, j \in \{1, 2\}} \text{Lip}(f_i^j)$, where $\text{Lip}(f_i^j)$ denotes the Lipschitz constant of f_i^j , and for $i \in \llbracket 1, m \rrbracket$, $j \in \{1, 2\}$ and $t \geq 0$, we define \tilde{f}_i^j on $\mathbb{R}^m \times [0, +\infty)$ by

$$\tilde{f}_i^j(v, t) = av_i + e^{at}f_i^j(e^{-at}v).$$

For $i \in \llbracket 1, m \rrbracket$ and $j \in \{1, 2\}$, by the choice of a and since \tilde{f}_i^j satisfy (2.1.3), the function \tilde{f}_i^j is nondecreasing in its first argument. Since $f_i^1 \leq f_i^2$ in \mathbb{R}^m , we have at any time $t \geq 0$, $\tilde{f}_i^1(\cdot, t) \leq \tilde{f}_i^2(\cdot, t)$.

For $j \in \{1, 2\}$, we define $\tilde{F}^j = (\tilde{f}_i^j)_{i=1}^m$, and consider the system

$$\begin{cases} \partial_t \tilde{u}^j + L\tilde{u}^j &= \tilde{F}^j(\tilde{u}^j, t) & x \in \mathbb{R}^d, t > 0, \\ \tilde{u}^j(\cdot, 0) &= u_0^j, & x \in \mathbb{R}^d. \end{cases} \quad (2.3.1)$$

From Remark 2.2.1, we know that $\tilde{u}^j(\cdot, t) = e^{at}u^j(\cdot, t)$ is the solution to (2.3.1), where u^j is the mild solution defined in Theorem 2.3.1. Therefore, it is enough to prove that $\tilde{u}^1 \leq \tilde{u}^2$ on $\mathbb{R}^d \times (0, +\infty)$. Consider the mapping N^j for $j = \{1, 2\}$, defined by

$$N^j(w)(\cdot, t) := \mathbb{T}_t u_0^j + \int_0^t \mathbb{T}_{t-s} \tilde{F}^j(w(\cdot, s), s) ds.$$

Taking $u^{0,j}(\cdot, t) = \mathbb{T}_t u_0^j$, we know that

$$\tilde{u}^j = \lim_{n \rightarrow +\infty} (N^j)^n(u^{0,j}).$$

Thus, by a standard induction argument, we only need to show that, for all $n \in \mathbb{N}$,

$$(N^1)^n(u^{0,1}) \leq (N^2)^n(u^{0,2}) \quad \text{on} \quad \mathbb{R}^d \times [0, +\infty). \quad (2.3.2)$$

Since, for all $i \in \llbracket 1, m \rrbracket$ and $j \in \{1, 2\}$, $u_i^1(0, \cdot) \leq u_i^2(0, \cdot)$, \tilde{f}_i^j is nondecreasing in its first argument and $\tilde{f}_i^1 \leq \tilde{f}_i^2$, then inequality (2.3.2) is true. This ends the proof of the theorem. \blacksquare

Remark 2.3.2. If, for all $i \in \llbracket 1, m \rrbracket$, we suppose $f_i^1 \leq f_i^2$ in \mathbb{R}_+^m , and $0 \leq u_i^1(\cdot, 0) \leq u_i^2(\cdot, 0)$ in \mathbb{R}^d , we obtain the same result as in Theorem 2.3.1.

Remark 2.3.3. Since $F(0) = 0$, Theorem 2.3.1 enables us to conclude that the solution $u = (u_i)_{i=1}^m$ to (2.1.1), starting from a non negative initial condition in X^m , satisfies $u_i(x, t) \geq 0$ for all $(x, t) \in \mathbb{R}^d \times [0, +\infty)$ and all $i \in \llbracket 1, m \rrbracket$.

2.3.2 Comparison principle for classical solutions

Now, we state the following comparison principle for classical solutions, required by Step 1 of the method given in the introduction of the thesis. This result will be useful in the following sections to deal with subsolutions and supersolutions to (2.1.1). Indeed, we have not devised a mild representation for subsolutions and supersolutions to this system, consequently the comparison principle stated in Theorem 2.3.1 will not, strictly speaking, be applicable.

Theorem 2.3.4. Let $u = (u_i)_{i=1}^m$ and $v = (v_i)_{i=1}^m$ be functions in $C^1([0, +\infty); C_0(\mathbb{R}^d))^m \cap \prod_{i=1}^m D_0((-\Delta)^{\alpha_i})$ such that, for all $i \in \llbracket 1, m \rrbracket$,

$$\partial_t u_i + (-\Delta)^{\alpha_i} u_i \leq f_i(u), \quad \text{and} \quad \partial_t v_i + (-\Delta)^{\alpha_i} v_i \geq f_i(v),$$

where f_i satisfies (2.1.3). If for all $i \in \llbracket 1, m \rrbracket$ and $x \in \mathbb{R}^d$, $u_i(x, 0) \leq v_i(x, 0)$ and for all $t \geq 0$

$$u_i(x, t) = O(|x|^{-(d+2\alpha)}) \quad \text{and} \quad v_i(x, t) = O(|x|^{-(d+2\alpha)}) \quad \text{as } |x| \rightarrow +\infty, \quad (2.3.3)$$

then

$$u(x, t) \leq v(x, t) \quad \text{for all } (x, t) \in \mathbb{R}^d \times \mathbb{R}_+.$$

Remark 2.3.5. The assumptions on u and v done in (2.3.3) are not optimal and seem to be restrictive, but are sufficient to prove our main result. In fact, in Lemma 2.4.2, we prove that the solution to (2.1.1) has the decay at infinity required by (2.3.3) and thus satisfies the hypotheses of Theorem 2.3.4.

Proof : For all $i \in \llbracket 1, m \rrbracket$, we define

$$w_i := u_i - v_i.$$

Then w_i satisfies $w_i(x, 0) \leq 0$ and, in $\mathbb{R}^d \times \mathbb{R}_+$, we have

$$\begin{aligned} \partial_t w_i + (-\Delta)^{\alpha_i} w_i &\leq f_i(u) - f_i(v) = \int_0^1 Df_i(\sigma u + (1-\sigma)v) d\sigma \cdot (u - v) \\ &= \int_0^1 Df_i(\zeta_\sigma) d\sigma \cdot w, \end{aligned} \quad (2.3.4)$$

where $\zeta_\sigma = \sigma u + (1-\sigma)v$. Let $T > 0$. By assumption, for all $i \in \llbracket 1, m \rrbracket$, the function w_i belongs to $C^1([0, +\infty); C_0(\mathbb{R}^d))$ and, consequently, there exist two positive constants $C_1(T)$ and $C_2(T)$ such that, for all $(x, t) \in \mathbb{R}^d \times [0, T]$,

$$|w_i(x, t)| \leq C_1(T) \quad \text{and} \quad |\partial_t w_i(x, t)| \leq C_2(T). \quad (2.3.5)$$

By (2.3.3), for all $t \in [0, T]$, we also have

$$w_i(x, t) = O(|x|^{-(d+2\alpha)}) \quad \text{as } |x| \rightarrow +\infty. \quad (2.3.6)$$

Let w_i^+ be the positive part of w_i . Since, for all $i \in \llbracket 1, m \rrbracket$, $w_i \in D_0((-\Delta)^{\alpha_i})$, we have

$$\int_{\mathbb{R}^d} w_i^+ (-\Delta)^{\alpha_i} w_i dx \geq 0.$$

Thus, using (2.3.5) and (2.3.6), we can multiply each term of (2.3.4) by w_i^+ and integrate over \mathbb{R}^d to get

$$\int_{\mathbb{R}^d} w_i^+ \partial_t w_i dx + \int_{\mathbb{R}^d} w_i^+ (-\Delta)^{\alpha_i} w_i dx \leq \int_{\mathbb{R}^d} w_i^+ \int_0^1 Df_i(\zeta_\sigma) d\sigma \cdot w dx. \quad (2.3.7)$$

Since $(w_i^+)^2$ and $\partial_t [(w_i^+)^2]$ are continuous in $\mathbb{R}^d \times (0, T)$, and since w_i satisfies (2.3.3), we also have

$$\frac{d}{dt} \left[\int_{\mathbb{R}^d} (w_i^+)^2 dx \right] = \int_{\mathbb{R}^d} \partial_t [(w_i^+)^2] dx.$$

Moreover, since the system is cooperative (i.e. $\partial_j f_i > 0$ on $[0, M]$), we have, for all $i \in \llbracket 1, m \rrbracket$

$$\begin{aligned} \frac{1}{2} \frac{d}{dt} \left[\int_{\mathbb{R}^d} (w_i^+)^2 dx \right] &\leq \int_{\mathbb{R}^d} \int_0^1 \partial_i f_i(\zeta_\sigma) d\sigma (w_i^+)^2 dx + \sum_{j=1, j \neq i}^m \int_{\mathbb{R}^d} \int_0^1 \partial_j f_i(\zeta_\sigma) d\sigma w_i^+ w_j^+ dx \\ &\leq C \sum_{j=1}^m \int_{\mathbb{R}^d} (w_j^+)^2 dx, \end{aligned}$$

where C is a constant that depends on m and T . Thus, for $t \in [0, T]$, we have

$$\frac{d}{dt} \left[\sum_{j=1}^m \int_{\mathbb{R}^d} (w_j^+)^2 dx \right] \leq C \sum_{j=1}^m \int_{\mathbb{R}^d} (w_j^+)^2 dx.$$

Finally Gronwall's inequality gives

$$0 \leq \sum_{j=1}^m \int_{\mathbb{R}^d} (w_j^+)^2 dx \leq e^{Ct} \sum_{j=1}^m \int_{\mathbb{R}^d} (w_j^+(0, x))^2 dx = 0,$$

which proves that, for all $j \in \llbracket 1, m \rrbracket$ and all $(x, t) \in \mathbb{R}^d \times [0, T]$,

$$w_j(x, t) \leq 0.$$

■

2.4 Upper bound for the solution to (2.1.1)

In this section, we prove that the solution u to (2.1.1) fulfills the hypothesis (2.3.3) of Theorem 2.3.4.

From (H5), we know that, for all $i \in \llbracket 1, m \rrbracket$, the functions f_i satisfy for all $j \in \llbracket 1, m \rrbracket$

$$|\partial_j f_i(s)| \leq Lip(f_i), \quad \text{for all } s \in \mathbb{R}^m,$$

where $Lip(f_i)$ is the Lipschitz constant of f_i . Taking $a = \max_{i \in \llbracket 1, m \rrbracket} Lip(f_i)$, we have for all $s = (s_i)_{i=1}^m \geq 0$

$$f_i(s) = \int_0^1 Df_i(\sigma s) d\sigma \cdot s \leq \left| \sum_{j=1}^m s_j \int_0^1 \partial_j f_i(\sigma s) d\sigma \right| \leq a \sum_{j=1}^m s_j. \quad (2.4.1)$$

Let us consider $v = (v_i)_{i=1}^m$ the mild solution of the following system

$$\begin{cases} \partial_t v + Lv = Bv, & x \in \mathbb{R}^d, t > 0, \\ v(\cdot, 0) = u_0, & \mathbb{R}^d, \end{cases} \quad (2.4.2)$$

where $B = (b_{ij})_{i,j=1}^m$ is a matrix with $b_{ij} = a$ for all $i, j \in \llbracket 1, m \rrbracket$. By (2.4.1) and Remark 2.3.2, we conclude that

$$u \leq v, \quad \text{in } \mathbb{R}^d \times [0, +\infty).$$

Since u_0 belongs to the domain $\prod_{i=1}^m D_0(A_i)$, u and v are global in time classical solutions. Taking Fourier transform in space in each term of system (2.4.2), we have

$$\begin{cases} \partial_t \mathfrak{F}(v) = (A(|\xi|) + B)\mathfrak{F}(v), & \xi \in \mathbb{R}^d, t > 0, \\ \mathfrak{F}(v)(\cdot, 0) = \mathfrak{F}(u_0), & \mathbb{R}^d, \end{cases}$$

where $A(|\xi|) = \text{diag}(-|\xi|^{2\alpha_1}, \dots, -|\xi|^{2\alpha_m})$. Thus, we have

$$\mathfrak{F}(v)(t, \xi) = e^{(A(|\cdot|) + B)t} \mathfrak{F}(u_0)(\xi),$$

and for all $x \in \mathbb{R}^d$ and all $t \geq 0$:

$$u(x, t) \leq v(x, t) = \mathfrak{F}^{-1}(e^{(A(|\cdot|) + B)t}) \star u_0(x). \quad (2.4.3)$$

In what follows, we prove that for each time $t > 0$, the solution u of (2.1.1) decays as $|x|^{-d-2\alpha}$ for large values of $|x|$, which proves that u satisfies (2.3.3). Due to (2.4.3) and since u_0 satisfies (2.1.2), we only need to prove that the entries of $\mathfrak{F}^{-1}(e^{(A(|\cdot|) + B)t})$ have the desired decay. To estimate from above these quantities, as done in [20] and [75], we need to rotate the integration line of a small angle $\varepsilon > 0$ in the expression of $\mathfrak{F}^{-1}(e^{(A(|\cdot|) + B)t})$. The following lemma will be needed when doing this rotation.

Lemma 2.4.1. *For all $z \in \left\{ z \in \mathbb{C} \mid |\arg(z)| < \frac{\pi}{4\alpha_1} \right\}$ and $t \geq 0$, we have :*

1. *the following estimate :*

$$\left| e^{(A(z) + B)t} \right| \leq e^{(m^2|B| - |z|^{2\alpha_1} \cos(2\alpha_1 \arg(z)))t} + e^{(m^2|B| - |z|^{2\alpha} \cos(2\alpha_1 \arg(z)))t}, \quad (2.4.4)$$

2. the existence of a locally bounded function $C_2 : (0, +\infty) \rightarrow \mathbb{R}_+$ such that

$$|I_t(z)| \leq C_2(t)(|z|^{2\alpha_1} e^{-|z|^{2\alpha} \cos(2\alpha_1 \arg(z))t} + |z|^{2\alpha} e^{-|z|^{2\alpha_1} \cos(2\alpha_1 \arg(z))t}), \quad (2.4.5)$$

where

$$I_t(z) := \int_0^t e^{(t-s)(A(z)+B)} [e^{sB}, A(z)] e^{sA(z)} ds. \quad (2.4.6)$$

Proof : Let z be in $\{z \in \mathbb{C} \mid |\arg(z)| < \frac{\pi}{4\alpha_1}\}$. Consider, for $j \in \llbracket 1, m \rrbracket$, the system

$$\begin{cases} \partial_t w &= (A(z) + B)w, & z \in \mathbb{C}, t > 0, \\ w(z, 0) &= e_j & z \in \mathbb{C}, \end{cases}$$

where e_j is the j th vector of the canonical basis of \mathbb{R}^d . Thus, we have

$$w(z, t) = e^{(A(z)+B)t} e_j. \quad (2.4.7)$$

Multiply the equation solved by w by the conjugate transpose \bar{w} and take the real part to get

$$\frac{1}{2} \partial_t |w|^2 + \sum_{l=1}^m \cos(2\alpha_l \arg(z)) |z|^{2\alpha_l} |w_l|^2 = \operatorname{Re}(Bw \cdot \bar{w}) \leq m^2 |B| |w|^2.$$

The choice of $\arg(z)$, Gronwall's Lemma and equation (2.4.7) end the proof of the first point of the lemma.

To prove (2.4.5), it is sufficient to notice that, for $s \in [0, t]$, we have

$$\left| e^{sA(|z|e^{i\arg(z)})} \right| \leq e^{-|z|^{2\alpha} \cos(2\alpha_1 \arg(z))s} + e^{-|z|^{2\alpha_1} \cos(2\alpha_1 \arg(z))s},$$

and

$$\left| [e^{sB}, A(|z|e^{i\arg(z)})] \right| \leq C(s)(|z|^{2\alpha} + |z|^{2\alpha_1}),$$

where $C : (0, +\infty) \rightarrow \mathbb{R}_+$ is a locally bounded function. Due to (2.4.4), we also have

$$\left| e^{(A(|z|e^{i\arg(z)})+B)(t-s)} \right| \leq e^{(m^2|B|-|z|^{2\alpha_1} \cos(2\alpha_1 \arg(z)))(t-s)} + e^{(m^2|B|-|z|^{2\alpha} \cos(2\alpha_1 \arg(z)))(t-s)}.$$

These three estimates end the proof of the lemma. ■

We are now in position to prove that u , the solution to (2.1.1), satisfies the assumption of our comparison principle for classical solutions.

Lemma 2.4.2. *Let $d \geq 1$ and let $u = (u_i)_{i=1}^m$ be the mild solution of system (2.1.1), with initial condition u_0 satisfying (2.1.2) and reaction term $F = (f_i)_{i=1}^m$ satisfying (2.1.3) and hypotheses (H1) to (H5). Then, for all $i \in \llbracket 1, m \rrbracket$, there exists a locally bounded function $C_1 : (0, +\infty) \rightarrow \mathbb{R}_+$ such that for all $t > 0$ and for large values of $|x|$, we have*

$$u_i(x, t) \leq \frac{C_1(t)}{|x|^{d+2\alpha}}.$$

We split the proof of Lemma 2.4.2 into two cases. First, for the sake of simplicity, we consider the one space dimension case to underline the idea of the proof. The higher space dimension case is treated after and requires the use of the Bessel function of first kind and the Whittaker function.

Proof for $d = 1$: In this proof, we denote by $C : (0, +\infty) \rightarrow \mathbb{R}_+$ any locally bounded function. As explained before, from (2.4.3), we only have to find an upper bound to the entries of $\mathfrak{F}^{-1}(e^{A(\cdot|\cdot)+B}t)$. First, we define for $t \geq 0$ and $z \in \mathbb{C}$, the function w by

$$w(z, t) := e^{tB} e^{tA(z)}.$$

This function w solves the Cauchy problem

$$\begin{cases} \partial_t w = (A(z) + B)w + [e^{tB}, A(z)]e^{tA(z)}, & z \in \mathbb{C}, t > 0, \\ w(z, 0) = Id, & z \in \mathbb{C}, \end{cases}$$

where $[e^{tB}, A(z)] = e^{tB}A(z) - A(z)e^{tB}$. By Duhamel's formula, we get for all $z \in \mathbb{C}$ and $t \geq 0$:

$$e^{t(A(z)+B)} = e^{tB} e^{tA(z)} - \int_0^t e^{(t-s)(A(z)+B)} [e^{sB}, A(z)] e^{sA(z)} ds. \quad (2.4.8)$$

Thus, for all $t > 0$ and all $x \in \mathbb{R}$, we have

$$\begin{aligned} \mathfrak{F}^{-1}(e^{A(\cdot|\cdot)+B}t)(x) &= \int_{\mathbb{R}} e^{ix\xi} e^{A(|\xi|)+B}t d\xi = \int_{\mathbb{R}} e^{ix\xi} e^{tB} e^{tA(|\xi|)} d\xi - \int_{\mathbb{R}} e^{ix\xi} I_t(|\xi|) d\xi \\ &= e^{tB} \text{diag}(p_{\alpha_1}(x, t), \dots, p_{\alpha_m}(x, t)) - \int_{\mathbb{R}} e^{ix\xi} I_t(|\xi|) d\xi, \end{aligned} \quad (2.4.9)$$

where, for $i \in \llbracket 1, m \rrbracket$, p_{α_i} is the heat kernel of the operator $(-\Delta)^{\alpha_i}$ in \mathbb{R} , that satisfies for $x \in \mathbb{R}$ and $t > 0$

$$\begin{cases} p_{\alpha_i}(x, t) = \frac{e^{-\frac{|x|^2}{4t}}}{\sqrt{4\pi t}}, & \text{if } \alpha_i = 1, \\ \frac{B^{-1}t}{t^{\frac{1}{2\alpha_i}+1} + |x|^{1+2\alpha_i}} \leq p_{\alpha_i}(x, t) \leq \frac{Bt}{t^{\frac{1}{2\alpha_i}+1} + |x|^{1+2\alpha_i}}, & \text{if } \alpha_i \in (0, 1). \end{cases} \quad (2.4.10)$$

Since $\alpha = \min_{i \in \llbracket 1, m \rrbracket} \alpha_i \in (0, 1)$, for large values of $|x|$, we clearly have

$$\|e^{tB} \text{diag}(p_{\alpha_1}(x, t), \dots, p_{\alpha_m}(x, t))\| \leq \frac{C(t)}{|x|^{1+2\alpha}}. \quad (2.4.11)$$

It remains to bound from above the following quantity :

$$\int_{\mathbb{R}} e^{ix\xi} I_t(|\xi|) d\xi = 2 \int_0^{+\infty} \cos(|x|r) I_t(r) dr = 2 \Re \left(\int_0^{+\infty} e^{i|x|r} I_t(r) dr \right).$$

We use the following two facts. First, for all $t \geq 0$, the function

$$z \mapsto e^{ixz} I_t(z)$$

is holomorphic on $\mathbb{C} \setminus \{0\}$. Second, taking $\varepsilon \in (0, \frac{\pi}{4\alpha_1})$, for $\delta > 0$ (respectively $R > 0$), on the arc $\{\pm\delta e^{i\theta}, \theta \in [0, \varepsilon]\}$ (respectively $\{\pm R e^{i\theta}, \theta \in [0, \varepsilon]\}$), the entries of I_t tends to 0 as δ tends to 0 (respectively R tends to $+\infty$), due to Lemma 2.4.1. Consequently, we can rotate the integration line of a small angle $0 < \varepsilon < \min(\pi, \frac{\pi}{4\alpha_1})$, and the quantity we have to bound from above becomes

$$\int_0^{+\infty} e^{i|x|re^{i\varepsilon}} I_t(re^{i\varepsilon}) dr \quad \text{with} \quad I_t(re^{i\varepsilon}) = \int_0^t e^{(t-s)(A(re^{i\varepsilon})+B)} [e^{sB}, A(re^{i\varepsilon})] e^{sA(re^{i\varepsilon})} ds.$$

From Lemma 2.4.1, we get for large values of $|x|$

$$\begin{aligned} \left| \int_0^{+\infty} e^{i|x|re^{i\varepsilon}} I_t(re^{i\varepsilon}) e^{i\varepsilon} dr \right| &\leq C(t) \left(\int_0^{+\infty} e^{-|x|r \sin(\varepsilon)} r^{2\alpha_1} e^{-r^{2\alpha} \cos(2\alpha_1\varepsilon)t} \right. \\ &\quad \left. + e^{-|x|r \sin(\varepsilon)} r^{2\alpha} e^{-r^{2\alpha_1} \cos(2\alpha_1\varepsilon)t} dr \right) \\ &\leq \frac{C(t)}{|x|^{1+2\alpha}} \left(\int_0^{+\infty} e^{-\tilde{r} \sin(\varepsilon)} \tilde{r}^{2\alpha_1} e^{-\frac{\tilde{r}^{2\alpha}}{|x|^{2\alpha}} \cos(2\alpha_1\varepsilon)t} \right. \\ &\quad \left. + e^{-\tilde{r} \sin(\varepsilon)} \tilde{r}^{2\alpha} e^{-\frac{\tilde{r}^{2\alpha}}{|x|^{2\alpha}} \cos(2\alpha_1\varepsilon)t} d\tilde{r} \right) \\ &\leq \frac{C(t)}{|x|^{1+2\alpha}}. \end{aligned} \tag{2.4.12}$$

With (2.4.9), (2.4.11) and (2.4.12), we conclude that for large values of $|x|$ and for all $t \geq 0$

$$|\mathfrak{F}^{-1}(e^{(A(|\cdot|)+B)t})(x)| \leq \frac{C(t)}{|x|^{1+2\alpha}},$$

which concludes the proof. ■

Proof for $d \geq 2$: As previously, from (2.4.3), we only need to bound from above the function $\mathfrak{F}^{-1}(e^{(A(|\cdot|)+B)t})$. Let $t > 0$ and $|x| > 1$. Using the spherical coordinates system in dimension $d \geq 2$ and the definition of the Bessel Function of first kind (see [1] and [41]), we have

$$\begin{aligned} \mathfrak{F}^{-1}(e^{(A(|\cdot|)+B)t})(x) &= C_d \int_0^{+\infty} \int_{-1}^1 e^{(A(r)+B)t} \cos(|x|rs) r^{d-1} (1-s^2)^{\frac{d-3}{2}} ds dr \\ &= \frac{C_d}{|x|^{\frac{d}{2}-1}} \int_0^{+\infty} e^{(A(r)+B)t} J_{\frac{d}{2}-1}(|x|r) r^{\frac{d}{2}} dr, \end{aligned}$$

where C_d is a positive constant depending on d .

The matrix $e^{(A(r)+B)t}$ is split into two pieces as done in (2.4.9), to get

$$\mathfrak{F}^{-1}(e^{(A(\cdot)+B)t})(x) = e^{tB} \operatorname{diag}(p_{\alpha_1}(x, t), \dots, p_{\alpha_m}(x, t)) - \frac{C_d}{|x|^{\frac{d}{2}-1}} \int_0^{+\infty} I_t(r) J_{\frac{d}{2}-1}(|x|r) r^{\frac{d}{2}} dr,$$

where I_t has been defined in (2.4.6). Since for $x \in \mathbb{R}^d$ and $t > 0$

$$\begin{cases} p_{\alpha_i}(x, t) = \frac{e^{-\frac{|x|^2}{4t}}}{(4\pi t)^{\frac{d}{2}}}, & \text{if } \alpha_i = 1, \\ \frac{Bt}{t^{\frac{d}{2\alpha_i}+1} + |x|^{d+2\alpha_i}} \leq p_{\alpha_i}(x, t) \leq \frac{Bt}{t^{\frac{d}{2\alpha_i}+1} + |x|^{d+2\alpha_i}}, & \text{if } \alpha_i \in (0, 1), \end{cases}$$

the first piece of the right hand side has the correct algebraic decay. It remains to bound from above the second piece. In fact, using the Whittaker function (defined in [41] for example), we have for all $x \in \mathbb{R}^d$ and all $t > 0$:

$$\begin{aligned} \int_0^{+\infty} I_t(r) J_{\frac{d}{2}-1}(|x|r) r^{\frac{d}{2}} dr &= \frac{\sqrt{2}}{\sqrt{\pi}} \Re \left(\int_0^{+\infty} I_t(r) e^{\frac{d-1}{4}i\pi} W_{0, \frac{d}{2}-1}(2i|x|r) r^{\frac{d-1}{2}} dr \right) \\ &= \frac{\sqrt{2\pi^{-1}}}{|x|^{\frac{d+1}{2}}} \Re \left(\int_0^{+\infty} I_t(\tilde{r}|x|^{-1}) e^{\frac{d-1}{4}i\pi} W_{0, \frac{d}{2}-1}(2i\tilde{r}) \tilde{r}^{\frac{d-1}{2}} d\tilde{r} \right). \end{aligned}$$

As done in the one dimension case, taking $0 < \varepsilon < \min(\pi, \frac{\pi}{4\alpha_1})$ and since the Whittaker function is bounded on the arc $\{2Rie^{i\theta}, \theta \in [-\varepsilon, 0]\}$ for R large, we can rotate the integration line a small angle $-\varepsilon$. Thus, using (2.4.5), we have the result if we prove that the following integral

$$\int_0^{+\infty} \left| W_{0, \frac{d}{2}-1}(2i\tilde{r}e^{-i\varepsilon}) \right| \tilde{r}^{\frac{d-1}{2}} (\tilde{r}^{2\alpha_1} + \tilde{r}^{2\alpha}) d\tilde{r}$$

is convergent. This integral is finite as proved by the following asymptotic expressions for $W_{0, \frac{d}{2}-1}$ (given in [1]) :

$$W_{0, \frac{d}{2}-1}(z) \underset{|z| \rightarrow +\infty}{\sim} e^{-\frac{z}{2}},$$

and

$$W_{0, \frac{d}{2}-1}(z) \underset{|z| \rightarrow 0}{\sim} \begin{cases} -\Gamma(\frac{d-1}{2})^{-1} \left(\ln(z) + \frac{\Gamma'(\frac{d-1}{2})}{\Gamma(\frac{d-1}{2})} \right) z^{\frac{d-1}{2}}, & \text{if } d = 2, \\ \frac{\Gamma(d-2)}{\Gamma(\frac{d-1}{2})} z^{\frac{3-d}{2}}, & \text{if } d \geq 3. \end{cases}$$

■

Remark 2.4.3. As a consequence of Lemma 2.4.2, we have the enough regularity to apply Theorem 2.3.4 to the solution to (2.1.1). It is clear that 0 is a subsolution to (2.1.1), and from Remark 2.1.1, $M = \Lambda 1$ is a supersolution to (2.1.1). For an initial

vector $u_0 = (u_{0i})_{i=1}^m$ smaller than M (in the sense that all the functions u_{0i} are smaller than Λ), we can not directly apply Theorem 2.3.4 to prove that the solution u to (2.1.1) is bounded from above by the constant vector M , since a constant vector is not in $\mathcal{C}_0(\mathbb{R}^d)$. However, we can adapt the proof of Theorem 2.3.4 to get this upper bound on u .

Indeed, let u denote the solution to (2.1.1) with non identically equal to 0 and continuous initial condition $u_0 = (u_{0i})_{i=1}^m$ satisfying for all $i \in \llbracket 1, m \rrbracket$, $u_{0i}(x) = O(|x|^{-(d+2\alpha)})$, and $0 \leq u_{0i} \leq M$ in \mathbb{R}^d , and reaction term $F = (f_i)_{i=1}^m$ satisfying (2.1.3) and hypotheses (H1) to (H5). From section 2.2, we know that u is a classical solution to (2.1.1) and at any time $t > 0$, $u(\cdot, t) \in \mathcal{C}_0(\mathbb{R}^d)$.

Consider for $x \in \mathbb{R}^d$ and $t \geq 0$

$$w(x, t) = (w_i(x, t))_{i=1}^m = e^{-lt}(u(x, t) - M),$$

where $l > 0$ is the maximum, taken over $\llbracket 1, m \rrbracket$, of the Lipschitz constants of f_i . Thus, for all $i \in \llbracket 1, m \rrbracket$, w_i solves on $\mathbb{R}^d \times (0, +\infty)$

$$\partial_t w_i + (-\Delta)^{\alpha_i} w_i \leq l(|w_i| - w_i).$$

As in the proof of Theorem 2.3.4, we multiply this inequality by the positive part w_i^+ of w_i , and integrate over \mathbb{R}^d . All the integrals converge since w_i^+ is continuous and compactly supported. Moreover, we have

$$\int_{\mathbb{R}^d} l(|w_i| - w_i)w_i^+ dx = 0,$$

which leads to the same conclusion as in Theorem 2.3.4. Thus, starting from $u_0 = (u_{0i})_{i=1}^m$ smaller than M , we have

$$0 \leq u(x, t) \leq M, \quad \text{for all } (x, t) \in \mathbb{R}^d \times [0, +\infty).$$

2.5 Lower bound for the solution to (2.1.1)

The following is the last important result needed to prove Theorem 2.1.2. It corresponds to Step 3 of the method described in section B.1. of the introduction. It sets an algebraically decaying lower bound for the solutions to the cooperative system (2.1.1).

Recall that $M = \Lambda 1$, where Λ is given in (H2). From Remark 2.4.3, we know that if the initial condition is non negative and smaller than M , then the solution u remains non negative and smaller than M at any time. Thus it is sufficient to work in the set $\{s = (s_i)_{i=1}^m \in \mathbb{R}^m \mid 0 \leq s \leq M\}$.

Since for all $i \in \llbracket 1, m \rrbracket$, $f_i(0) = 0$, we have for all $s = (s_i)_{i=1}^m \in \mathbb{R}^m$ with $0 \leq s \leq M$:

$$f_i(s) = \int_0^1 Df_i(\sigma s) d\sigma \cdot s = \sum_{j=1}^m s_j \int_0^1 \partial_j f_i(\zeta_\sigma) d\sigma,$$

where $\zeta_\sigma = \sigma s \in [0, M]$. In the sequel, we use that for all $i \in \llbracket 1, m \rrbracket$ and $j \in \llbracket 1, m \rrbracket$, $\partial_j f_i : [0, M] \rightarrow \mathbb{R}$ is continuous and that the system is cooperative. Consequently, for all $i \in \llbracket 1, m \rrbracket$ and $j \in \llbracket 1, m \rrbracket$, there exist constants $\gamma_{ij} > 0$ such that for all $\sigma \in [0, 1]$:

$$|\partial_i f_i(\zeta_\sigma)| \leq \gamma_{ii} \quad \text{and} \quad \gamma_{ij} \leq \partial_j f_i(\zeta_\sigma). \quad (2.5.1)$$

Lemma 2.5.1. *Let $u = (u_i)_{i=1}^m$ be the solution to (2.1.1), with non negative, non identically equal to 0 and continuous initial condition u_0 satisfying (2.1.2) and with reaction term $F = (f_i)_{i=1}^m$ satisfying (2.1.3), (H1), (H2) and (H5). Then, for all $i \in \llbracket 1, m \rrbracket$, $x \in \mathbb{R}^d$ and $t \geq 1$, we have :*

$$u_i(x, t) \geq \frac{\underline{c} t e^{-\gamma_{mm} t}}{t^{\frac{d}{2\alpha}+1} + |x|^{d+2\alpha}}, \quad (2.5.2)$$

where \underline{c} is a positive constant, γ_{mm} is defined in (2.5.1) and $\alpha = \min_{i \in \llbracket 1, m \rrbracket} \alpha_i$.

Proof : We split the proof into three steps.

- Step 1 : we prove (2.5.2) for $i = m$,
- Step 2 : for all $i \in \llbracket 1, m-1 \rrbracket$, $t \geq 1$ and $s \in [0, t-1]$, we find a lower bound of $p_{\alpha_i}(\cdot, t-s) \star (s^{\frac{d}{2\alpha}+1} + |\cdot|^{d+2\alpha})^{-1}$, that decays like $|x|^{-d+2\alpha}$ for large values of $|x|$,
- Step 3 : for all $i \in \llbracket 1, m-1 \rrbracket$, $t \geq 1$ and $s \in [0, t-1]$, we prove that $u_i(\cdot, t)$ can be bounded from below by an expression that only depends on the integral $\int_0^t p_{\alpha_i}(\cdot, t-s) \star (s^{\frac{d}{2\alpha}+1} + |\cdot|^{d+2\alpha})^{-1} ds$.

Step 1. By (2.5.1) and since u is a classical solution to (2.1.1), we have for all $x \in \mathbb{R}^d$ and $t > 0$:

$$\partial_t u_m + (-\Delta)^{\alpha_m} u_m = f_m(u) \geq \int_0^1 \partial_m f_m(\zeta_\sigma) d\sigma u_m \geq -\gamma_{mm} u_m.$$

The standard maximum principle of reaction-diffusion equations gives, for all $t \geq 0$,

$$u_m(x, t) \geq e^{-\gamma_{mm} t} (p_\alpha(\cdot, t) \star u_{0m})(x). \quad (2.5.3)$$

Since $u_{0m} \not\equiv 0$ is continuous and nonnegative, there exists a constant $R > 0$ such that

$$\int_{B_R(0)} u_{0m}(y) dy > 0.$$

As proved in Lemma 2.2 of [26], one easily sees that, there exists $c \in (0, 1)$ such that for $|x| \geq R$ and $t > 0$

$$p_\alpha(\cdot, t) \star u_{0m}(x) \geq \frac{ct}{t^{\frac{d}{2\alpha}+1} + |x|^{d+2\alpha}}. \quad (2.5.4)$$

For $|x| \leq R$ and $t \geq 0$, using the lower bound of p_α for $\alpha = \min_{i \in [1, m]} \alpha_i \in (0, 1)$, recalled in (2.4.10), we have

$$\begin{aligned} p_\alpha(t, \cdot) \star u_{0m}(x) &\geq \int_{B_R(0)} \frac{B^{-1} t u_{0m}(y)}{t^{\frac{d}{2\alpha}+1} + |x-y|^{d+2\alpha}} dy \\ &\geq \frac{ct}{t^{\frac{d}{2\alpha}+1} + |x|^{d+2\alpha}}, \end{aligned} \quad (2.5.5)$$

taking c smaller if necessary. Inserting (2.5.4) and (2.5.5) in (2.5.3), we have for $x \in \mathbb{R}^d$ and $t \geq 0$

$$u_m(x, t) \geq \frac{ct e^{-\gamma_{mm} t}}{t^{\frac{d}{2\alpha}+1} + |x|^{d+2\alpha}}. \quad (2.5.6)$$

Step 2. For $t \geq 1$ and $s \in [0, t-1]$, we estimate from below the function $p_{\alpha_i}(\cdot, t-s) \star p_\alpha(\cdot, s)$, where for $x \in \mathbb{R}^d$ and $t > 0$

$$p_{\alpha_i}(x, t) = \frac{e^{-\frac{|x|^2}{4t}}}{(4\pi t)^{\frac{d}{2}}}, \quad \text{if } \alpha_i = 1,$$

and

$$p_{\alpha_i}(x, t) \geq \frac{B^{-1} t}{t^{\frac{d}{2\alpha_i}+1} + |x|^{d+2\alpha_i}}, \quad \text{if } \alpha_i \in (0, 1).$$

Set, for $x \in \mathbb{R}^d$, $t \geq 1$ and $s \in [0, t-1]$:

$$q(x, t, s) = p_{\alpha_i}(\cdot, t-s) \star \frac{1}{s^{\frac{d}{2\alpha}+1} + |\cdot|^{d+2\alpha}}(x).$$

– When $\alpha_i = 1$, we have for all $x \in \mathbb{R}^d$, $t \geq 1$ and $s \in [0, t-1]$

$$\begin{aligned} q(x, t, s) &\geq \frac{1}{(4\pi(t-s))^{\frac{d}{2}}} \int_{\mathbb{R}^d} \frac{e^{-\frac{|y|^2}{4(t-s)}}}{s^{\frac{d}{2\alpha}+1} + |x-y|^{d+2\alpha}} dy \\ &\geq \frac{1}{(4\pi(t-s))^{\frac{d}{2}} (s^{\frac{d}{2\alpha}+1} + |x|^{d+2\alpha})}. \end{aligned} \quad (2.5.7)$$

– When $\alpha_i \in (0, 1)$, similarly to (2.5.7), we have for $x \in \mathbb{R}^d$, $t \geq 1$ and $s \in [0, t-1]$

$$\begin{aligned} q(x, t, s) &\geq \int_{\mathbb{R}^d} \frac{1}{((t-s)^{\frac{d}{2\alpha_i}+1} + |y|^{d+2\alpha_i})(s^{\frac{d}{2\alpha}+1} + |x-y|^{d+2\alpha})} dy \\ &\geq \frac{(t-s)^{-\frac{d}{2\alpha_i}}}{s^{\frac{d}{2\alpha}+1} + |x|^{d+2\alpha}}. \end{aligned} \quad (2.5.8)$$

Step 3. Using (2.5.1), we have for $i \in \llbracket 1, m-1 \rrbracket$, $x \in \mathbb{R}^d$ and $t \geq 0$

$$\partial_t u_i + (-\Delta)^{\alpha_i} u_i = f_i(u) \geq \int_0^1 \partial_m f_i(\zeta_\sigma) d\sigma u_m + \int_0^1 \partial_i f_i(\zeta_\sigma) d\sigma u_i \geq \gamma_{im} u_m - \delta_i u_i,$$

where $\delta_i \geq \max(\gamma_{ii}, \gamma_{mm} + 1)$. The maximum principle of reaction-diffusion equations and Duhamel's formula give for all $(x, t) \in \mathbb{R}^d \times \mathbb{R}_+$:

$$\begin{aligned} u_i(x, t) &\geq e^{-\delta_i t} p_{\alpha_i}(\cdot, t) \star u_{0i}(x) + \gamma_{im} e^{-\delta_i t} \int_0^t p_{\alpha_i}(\cdot, t-s) \star u_m(\cdot, s) e^{\delta_i s} ds, \\ &\geq \gamma_{im} e^{-\delta_i t} \int_0^{t-1} p_{\alpha_i}(\cdot, t-s) \star u_m(\cdot, s) e^{\delta_i s} ds. \end{aligned}$$

Using (2.5.6) and inequalities (2.5.7), (2.5.8) obtained in Step 2, we get the existence of a positive constant c_1 such that for all $x \in \mathbb{R}^d$, $t \geq 1$

$$\begin{aligned} u_i(x, t) &\geq c \gamma_{im} e^{-\delta_i t} \int_0^{t-1} s e^{-\gamma_{mm} s} p_{\alpha_i}(\cdot, t-s) \star (s^{\frac{d}{2\alpha}+1} + |\cdot|^{d+2\alpha})^{-1}(x) e^{\delta_i s} ds \\ &\geq \frac{c_1 t e^{-\gamma_{mm} t}}{t^{\frac{d}{2\alpha}+1} + |x|^{d+2\alpha}}. \end{aligned} \quad (2.5.9)$$

Inequalities (2.5.6) and (2.5.9) prove the lemma, taking $\underline{c} = \min(c_1, c)$. \blacksquare

2.6 Proof of Theorem 2.1.2

Inspired by the formal analysis done in section 1.2, we look for an explicit supersolution (respectively subsolution) to (2.1.1) of the form

$$v(x, t) = \frac{a}{\left(1 + b(t) |x|^{\delta(d+2\alpha)}\right)^{\frac{1}{\delta}}} \phi_1. \quad (2.6.1)$$

In this expression, b is a time continuous function asymptotically proportional to $e^{-\delta_1 \lambda_1 t}$, $\phi_1 = (\phi_{1,i})_{i=1}^m \in \mathbb{R}^m$ is the normalized principal eigenvector of $DF(0)$ associated to the principal eigenvalue λ_1 , and δ is equal to δ_1 (respectively δ_2) defined in (H3) (respectively (H4)). Since the system is cooperative, Perron-Frobenius Theorem gives $\phi_1 > 0$.

The effect of the fractional Laplacian $(-\Delta)^{\alpha_i}$ on the function v defined by (2.6.1) is given by Lemma 1.3.1 taking

$$\beta = d + 2\alpha \in (0, d + 2\alpha_i], \quad \lambda = b(t)^{\frac{1}{(d+2\alpha)\delta}}, \quad \text{and} \quad h(x) = \frac{1}{\left(1 + |x|^{\delta(d+2\alpha)}\right)^{\frac{1}{\delta}}}.$$

Since $\delta(d+2\alpha) \geq 2$, the function h is of class $\mathcal{C}^2(\mathbb{R}^d)$ and satisfies all the assumptions of Lemma 1.3.1. Consequently, taking D larger if necessary in Lemma 1.3.1, we have for all $i \in \llbracket 1, m \rrbracket$, $t > 0$ and $x \in \mathbb{R}^d$

$$|(-\Delta)^{\alpha_i} v_i(x, t)| \leq Db(t)^{\frac{2\alpha_i}{\delta(d+2\alpha)}} v_i(x, t). \quad (2.6.2)$$

The end of this chapter is devoted to Step 4 of the method given in the introduction of the thesis. A classical supersolution (respectively subsolution) to (2.1.1) of the form (2.6.1), with appropriate choices of a , δ and $b(t)$, is constructed and used to prove Lemma 2.6.1 (respectively Lemma 2.6.2). These two lemmas lead to the proof of Theorem 2.1.2.

Lemma 2.6.1. *Let $d \geq 1$ and u be the solution to (2.1.1) with non negative, non identically equal to 0 and continuous initial condition u_0 satisfying (2.1.2) and $F = (f_i)_{i=1}^m$ satisfying (2.1.3), (H1), (H2), (H3) and (H5). Then, for every $\mu = (\mu_i)_{i=1}^m > 0$, there exists a constant $c_\mu > 0$ such that, for all $t > \tau$, with $\tau > 0$ large enough*

$$\left\{ x \in \mathbb{R}^d \mid |x| > c_\mu e^{\frac{\lambda_1}{d+2\alpha} t} \right\} \subset \left\{ x \in \mathbb{R}^d \mid u(x, t) < \mu \right\}.$$

Proof : The proof is in the same spirit as the one done in Chapter 1. For the sake of completeness, we write it in the case of monotone systems. We consider the function \bar{u} of the form (2.6.1), on $\mathbb{R}^d \times \mathbb{R}_+$, with $\delta = \delta_1$ defined in (H3). The idea is to adjust $a > 0$ and $b(t)$ asymptotically proportional to $e^{-\delta_1 \lambda_1 t}$, so that the function \bar{u} serves as supersolution of (2.1.1). In the sequel, a is any positive constant satisfying

$$a \geq \left(\frac{D + \lambda_1}{c_{\delta_1}} \right)^{\frac{1}{\delta_1}} \max_{i \in \llbracket 1, m \rrbracket} \left(\frac{1}{\phi_{1,i}} \right),$$

where c_{δ_1} is defined in (H3), and $D > 0$ is given by (2.6.2). For any constant $B \in (0, (1 + D\lambda_1^{-1})^{-\frac{\delta_1(d+2\alpha)}{2\alpha}})$, we consider the following ordinary differential equation

$$b'(t) + \delta_1 Db(t)^{\frac{2\alpha}{\delta_1(d+2\alpha)} + 1} + \delta_1 \lambda_1 b(t) = 0, \quad b(0) = \left(-D\lambda_1^{-1} + B^{-\frac{2\alpha}{\delta_1(d+2\alpha)}} \right)^{-\frac{d+2\alpha}{2\alpha} \delta_1}, \quad (2.6.3)$$

whose solution is given by

$$b(t) = \left(-D\lambda_1^{-1} + B^{-\frac{2\alpha}{\delta_1(d+2\alpha)}} e^{\frac{2\alpha\lambda_1}{d+2\alpha} t} \right)^{-\frac{d+2\alpha}{2\alpha} \delta_1}.$$

For all $t \geq 0$, we have $b(t) \geq 0$ and more precisely

$$Be^{-\delta_1 t} \leq b(t) \leq b(0) \leq 1. \quad (2.6.4)$$

Defining

$$\mathcal{L}(\bar{u}_i) = \partial_t \bar{u}_i + (-\Delta)^{\alpha_i} \bar{u}_i - f_i(\bar{u}),$$

and using (2.6.2), we have for all $i \in \llbracket 1, m \rrbracket$

$$\begin{aligned} \mathcal{L}(\bar{u}_i) &= \partial_t \bar{u}_i + (-\Delta)^{\alpha_i} \bar{u}_i - Df_i(0)\bar{u} + [Df_i(0)\bar{u} - f_i(\bar{u})] \\ &\geq \frac{-a\phi_{1,i}}{\delta_1 \left(1 + b(t) |x|^{\delta_1(d+2\alpha)}\right)^{\frac{1}{\delta_1} + 1}} \left\{ b'(t) + \delta_1 D b(t)^{\frac{2\alpha}{\delta_1(d+2\alpha)} + 1} + \delta_1 \lambda_1 b(t) \right\} |x|^{\delta_1(d+2\alpha)} \\ &\quad + \frac{a\phi_{1,i}}{\left(1 + b(t) |x|^{\delta_1(d+2\alpha)}\right)^{\frac{1}{\delta_1} + 1}} \left\{ -D b(t)^{\frac{2\alpha}{\delta_1(d+2\alpha)}} - \lambda_1 + c_{\delta_1} \phi_{1,i}^{\delta_1} a^{\delta_1} \right\} \geq 0. \end{aligned}$$

Before using the comparison principle given in Theorem 2.3.4 to compare u and \bar{u} , we need to take into account initial data. Since u_0 satisfies (2.1.2), there exists a time $t_0 > 0$ such that, for all $i \in \llbracket 1, m \rrbracket$,

$$u_{0i} \leq \bar{u}_i(\cdot, t_0).$$

Thus, Theorem 2.3.4 gives for all $t \geq 0$, all $x \in \mathbb{R}^d$ and all $i \in \llbracket 1, m \rrbracket$:

$$u_i(x, t) \leq \bar{u}_i(x, t + t_0). \quad (2.6.5)$$

For any $(\mu_i)_{i=1}^m > 0$, we define for $i \in \llbracket 1, m \rrbracket$ the constants

$$c_i^{d+2\alpha} := a\phi_{1,i} e^{\lambda_1 t_0} [\mu_i B^{\frac{1}{\delta_1}}]^{-1} \quad \text{and} \quad c = \max_{i \in \llbracket 1, m \rrbracket} c_i.$$

Thus, if $|x| > ce^{\frac{\lambda_1}{d+2\alpha}t}$, then, using (2.6.4) for all $t \geq 0$ and all $i \in \llbracket 1, m \rrbracket$, we have

$$u_i(x, t) \leq \bar{u}_i(x, t + t_0) = \frac{a\phi_{1,i}}{(1 + b(t + t_0) |x|^{\delta_1(d+2\alpha)})^{\frac{1}{\delta_1}}} < \mu_i. \quad \blacksquare$$

Lemma 2.6.2. *Let $d \geq 1$ and u be the solution to (2.1.1) with non negative, non identically equal to 0 and continuous initial condition u_0 satisfying (2.1.2) and with a source term $F = (f_i)_{i=1}^m$ satisfying (2.1.3), (H1), (H2), (H4) and (H5). Then, for all $i \in \llbracket 1, m \rrbracket$, there exist constants $\varepsilon_i > 0$, $C_{\varepsilon_i} > 0$ and $t_1 > 0$ large enough such that,*

$$u_i(x, t) > \varepsilon_i, \quad \text{for all } t \geq t_1 \text{ and } |x| < C_{\varepsilon_i} e^{\frac{\lambda_1}{d+2\alpha}t}.$$

Proof : As in the previous proof, we consider the function \underline{u} of the form (2.6.1), on $\mathbb{R}^d \times \mathbb{R}_+$, with $\delta = \delta_2$ defined in (H4). Since for any $i \in \llbracket 1, m \rrbracket$, $\underline{u}_i(\cdot, 0) \leq u_{0i}$ may not hold, we look for a time $t_1 > 0$ such that $\underline{u}_i(\cdot, 0) \leq u_i(t_1, \cdot)$. Without loss of generality, we can assume that D is greater than λ_1 , where D is given by (2.6.2). We choose $t_1 \geq \max(1, 2D\lambda_1^{-1})$ and set

$$a = \frac{\underline{c} e^{-\gamma m t_1}}{2 \max_{i \in \llbracket 1, m \rrbracket} \phi_{1,i} t_1^{\frac{d}{2\alpha}}} \quad \text{and} \quad B = \left(\frac{2}{t_1} \right)^{\frac{d+2\alpha}{2\alpha} \delta_2}, \quad (2.6.6)$$

where \underline{c} is defined in Lemma 2.5.1. Thus we have

$$a \leq \left(\frac{\min_{i \in \llbracket 1, m \rrbracket} \phi_{1,i} \lambda_1}{2c_{\delta_2}} \right)^{\frac{1}{\delta_2}} \quad \text{and} \quad B \leq (D\lambda_1^{-1})^{-\frac{d+2\alpha}{2\alpha}\delta_2},$$

where c_{δ_2} is given by (H4). Similarly to the proof of Lemma 2.6.1, we define

$$b(t) = \left(D\lambda_1^{-1} + B^{-\frac{2\alpha}{\delta_2(d+2\alpha)}} e^{\frac{2\alpha\lambda_1}{d+2\alpha}t} \right)^{-\frac{d+2\alpha}{2\alpha}\delta_2},$$

and using (2.6.2) and (H4), we can state for all $i \in \llbracket 1, m \rrbracket$

$$\partial_t \underline{u}_i + (-\Delta)^{\alpha_i} \underline{u}_i - f_i(\underline{u}) \leq 0, \quad \text{in} \quad \mathbb{R}^d \times [0, +\infty).$$

From Lemma 2.5.1, we have for all $i \in \llbracket 1, m \rrbracket$ and all $x \in \mathbb{R}^d$

$$u_i(t_1, x) \geq \frac{\underline{c}t_1 e^{-\gamma_{mm}t_1}}{t_1^{\frac{d}{2\alpha}+1} + |x|^{d+2\alpha}}.$$

By (2.6.6), we deduce

$$\begin{aligned} \underline{c}t_1 e^{-\gamma_{mm}t_1} \left(1 + b(0) |x|^{\delta_2(d+2\alpha)} \right)^{\frac{1}{\delta_2}} &\geq \frac{\underline{c}}{2} t_1 e^{-\gamma_{mm}t_1} \left(1 + b(0)^{\frac{1}{\delta_2}} |x|^{d+2\alpha} \right) \\ &\geq a\phi_{1,i} \left(t_1^{\frac{d}{2\alpha}+1} + |x|^{d+2\alpha} \right). \end{aligned}$$

Therefore, we get, for all $i \in \llbracket 1, m \rrbracket$,

$$u_i(\cdot, t_1) \geq \underline{u}_{0i} \quad \text{in} \quad \mathbb{R}^d.$$

Theorem 2.3.4 gives for all $t \geq t_1$

$$u_i(\cdot, t) \geq \underline{u}_i(\cdot, t - t_1), \quad \text{in} \quad \mathbb{R}^d. \quad (2.6.7)$$

Finally we set

$$\varepsilon_i = 2^{-\frac{1}{\delta_2}} a\phi_{1,i} \quad \text{and} \quad C_{\varepsilon_i}^{d+2\alpha} = e^{-\lambda_1 t_1} B^{-\frac{1}{\delta_2}}.$$

If $t \geq t_1$ and $|x| \leq C_{\varepsilon_i} e^{\frac{\lambda_1}{d+2\alpha}t}$, using (2.6.7), we have

$$u_i(x, t) \geq \underline{u}_i(x, t - t_1) = \frac{a\phi_{1,i}}{\left(1 + b(t - t_1) |x|^{\delta_2(d+2\alpha)} \right)^{\frac{1}{\delta_2}}} \geq \frac{a\phi_{1,i}}{2^{\frac{1}{\delta_2}}} = \varepsilon_i.$$

■

Remark 2.6.3. Step 2 of the method described in the introduction of the thesis leads to rescale problem 2.1.1 in the x -variable, defining the vector $v = (v_i)_{i=1}^m$ by

$$v(y, t) = u(yr(t), t), \quad r(t) = e^{\frac{\lambda_1}{d+2\alpha}t}, \quad \text{for } y \in \mathbb{R}^d \text{ and } t \geq 0.$$

Neglecting the diffusive term in the equation satisfied by v , we get the following transport equation :

$$\partial_t \tilde{v}(y, t) - \frac{\lambda_1}{d+2\alpha} y \partial_y \tilde{v}(y, t) = F(\tilde{v}(y, t)), \quad y \in \mathbb{R}^d, t > 0. \quad (2.6.8)$$

In our proof, we have chosen not to work with an explicit solution of (2.6.8), but to look for subsolutions and supersolutions to (2.1.1) of the form (2.6.1), inspired by Chapter 1. However, if \tilde{v}_∞ denotes a positive stationary solution to (2.6.8), then the function $\psi(t) = \tilde{v}_\infty(e^{-\frac{\lambda_1}{d+2\alpha}t})$ satisfies

$$\psi'(t) = f(\psi(t)).$$

Thus, if u_+ denotes the smallest positive constant solution to (2.1.1), then the global orbit X connecting 0 and u_+ , i.e. a solution $X = (X_i)_{i=1}^m$ of

$$\begin{cases} \frac{d}{dt} X_i = f_i(X), & t \in \mathbb{R}, \\ X(-\infty) = 0, & X(+\infty) = u_+, \end{cases}$$

whose existence is given in [54], could serve to construct subsolutions and supersolution to (2.1.1). Indeed, the method given in the general introduction of the thesis consists in looking for subsolution and supersolution \tilde{v}_* of the form

$$\tilde{v}_*(x, t) = a \tilde{v}_\infty(b(t)x) = aX \left(-\frac{d+2\alpha}{\lambda_1} \ln(|x| b(t)) \right),$$

where $a > 0$ is a constant and $b(t)$ is asymptotically proportional to $e^{\lambda_1 t}$. Recall that ϕ_1 denotes the eigenfunction associated with the principal eigenvalue λ_1 of $DF(0)$, where $F = (f_i)_{i=1}^m$. We notice that the orbit X satisfies

$$X(t) \underset{t \rightarrow -\infty}{\sim} ce^{\lambda_1 t} \phi_1,$$

for a positive constant c . This means that, at any time $t \geq 0$, the function \tilde{v}_* decays like $|x|^{-(d+2\alpha)}$ for large values of $|x|$.

Part II

The influence of a line with fractional diffusion on Fisher-KPP propagation

Chapter 3

Existence, uniqueness, comparison principle

3.1 Introduction

This chapter gives general results and the framework of study on the problem, given in the introduction of the thesis, that concerns the presence of a line on Fisher-KPP equations.

We work in the Hilbert space $X = \{(v, u) \in L^2(\mathbb{R} \times \mathbb{R}_+) \times L^2(\mathbb{R})\}$ where the problem can be written as

$$\begin{cases} \partial_t v - \Delta v = f(v), & x \in \mathbb{R}, y > 0, t > 0, \\ \partial_t u + (-\partial_{xx})^\alpha u = -\mu u + \gamma_0 v - ku, & x \in \mathbb{R}, y = 0, t > 0, \\ \gamma_1 v = \mu u - \gamma_0 v, & x \in \mathbb{R}, y = 0, t > 0, \end{cases} \quad (3.1.1)$$

with $\mu > 0$, $k \geq 0$, γ_0 and γ_1 the trace operator and the normal trace operator. This system is completed with initial conditions $v(\cdot, \cdot, 0) = v_0$ and $u(\cdot, 0) = u_0$. The source term f is supposed to be of Fisher-KPP type of class $\mathcal{C}^\infty(\mathbb{R})$. We will see that this particular framework gives an explicit integral expression of the fundamental solution, that we are able to estimate from above. Thus, we will prove the existence and uniqueness of the solution to (3.1.1) in X and then the expected regularity for the solution.

Problem (3.1.1) can also be written

$$W_t + AW = F(W), \quad \text{where } W = \begin{pmatrix} v \\ u \end{pmatrix}, \quad F \begin{pmatrix} v \\ u \end{pmatrix} = \begin{pmatrix} f(v) \\ 0 \end{pmatrix}, \quad (3.1.2)$$

and A is defined by

$$A \begin{pmatrix} v \\ u \end{pmatrix} = \begin{pmatrix} -\Delta v \\ (-\partial_{xx})^\alpha u + \mu u - \gamma_0 v + ku \end{pmatrix}.$$

The domain of A is defined for $\tilde{\alpha} = \max(\alpha, 1/4)$ by

$$D(A) = \{(v, u) \in H^2(\mathbb{R} \times \mathbb{R}_+) \times H^{2\tilde{\alpha}}(\mathbb{R}) \mid \gamma_1 v = \mu u - \gamma_0 v\} \subset X.$$

The global existence and uniqueness of solutions to the Cauchy problem (3.1.1) is obtained in $D(A)$, with the aid of the abstract theory of sectorial operators.

For $\alpha \in (0, \frac{1}{4}]$, this framework does not enable us to prove more regularity on the solution : this case is not treated in this thesis. For $\alpha \in (\frac{1}{4}, 1)$, the properties of A and Sobolev embeddings lead to the regularity of the solution. We conclude this chapter proving a comparison principle.

In the sequel, some proofs are classical, like the closedness of the operator, and others are crucial, like the estimate of the resolvent; we give the details of all the proofs. For the sake of clarity, we often omit the variables of integration.

3.2 General results

3.2.1 Trace theory

In this section, we recall some results, extracted from [58], concerning trace theory that will be used in the sequel.

Theorem 3.2.1. *There exist two continuous linear maps γ_0 and γ_1 such that*

$$\gamma_0 : \begin{cases} H^1(\mathbb{R} \times \mathbb{R}_+) & \longrightarrow & H^{\frac{1}{2}}(\mathbb{R}) \\ h & \longmapsto & h(\cdot, 0) \end{cases} \quad \text{and} \quad \gamma_1 : \begin{cases} H^2(\mathbb{R} \times \mathbb{R}_+) & \longrightarrow & H^{\frac{1}{2}}(\mathbb{R}) \\ h & \longmapsto & -\partial_y h(\cdot, 0) \end{cases}.$$

This means the existence of a constant $C_{tr} > 0$ such that for all $h \in H^2(\mathbb{R} \times \mathbb{R}_+)$ we have

$$\|\gamma_0 h\|_{H^{\frac{1}{2}}(\mathbb{R})} \leq C_{tr} \|h\|_{H^1(\mathbb{R} \times \mathbb{R}_+)} \quad \text{and} \quad \|\gamma_1 h\|_{H^{\frac{1}{2}}(\mathbb{R})} \leq C_{tr} \|h\|_{H^2(\mathbb{R} \times \mathbb{R}_+)}.$$

3.2.2 Sectorial operators

The theory of sectorial operators is developed for example in [53] and [74]. In this section, we recall the main definitions and theorems that we will use in the sequel. In the following, $(X, \|\cdot\|)$ always denotes a Banach space and A an operator on X with domain $D(A)$.

Notation 3.2.2. *For $\omega \in \mathbb{R}$ and $\theta \in (0, \pi]$, we define $S_{\omega, \theta} := \{\lambda \in \mathbb{C} \mid \lambda \neq \omega, |\arg(\lambda - \omega)| < \theta\}$ the open sector with vertex at ω , symmetric about the positive real axis with opening angle 2θ . For $\theta = 0$, $S_{\omega, 0} := (\omega, +\infty)$.*

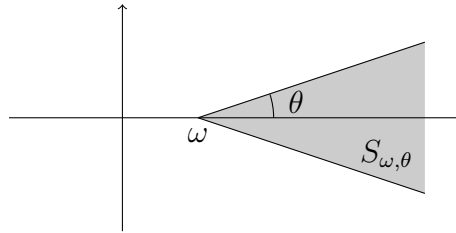

Example of sector $S_{\omega, \theta}$

Definition 3.2.3. A closed operator $A : D(A) \subset X \rightarrow X$ is called sectorial, with parameters ω and θ , if there exist constants $\omega \in \mathbb{R}$, $\theta \in [0, \pi)$ and $M > 0$ such that

1. $\rho(A) \supset \mathbb{C} \setminus S_{\omega, \theta}$,
2. $\|R(\lambda, A)\|_{\mathcal{L}(X)} \leq \frac{M}{|\lambda - \omega|}$, for all $\lambda \in \mathbb{C} \setminus S_{\omega, \theta}$, $\lambda \neq \omega$.

There exists a functional calculus for densely defined sectorial operators. This is an extension of the classical Dunford-functional calculus for bounded operators. The following theorem gives an integral representation of the semi group associated to the operator A . We will use it to estimate a supersolution to (3.1.1).

Theorem 3.2.4. Let A be a densely defined operator in X . If A is a sectorial operator with parameters ω and $\theta \in (0, \frac{\pi}{2})$, then A is the infinitesimal generator of an analytic semigroup $T(t)$. Moreover

$$T(t) = \frac{1}{2i\pi} \int_{\Gamma} e^{-\lambda t} (A - \lambda I)^{-1} d\lambda,$$

where Γ is any curve in $\mathbb{C} \setminus S_{\omega, \theta}$ running from $+\infty e^{-i\tilde{\theta}}$ to $+\infty e^{i\tilde{\theta}}$ for $\tilde{\theta} \in (\theta, \frac{\pi}{2})$. The integral converges for $t > 0$ in the uniform operator topology.

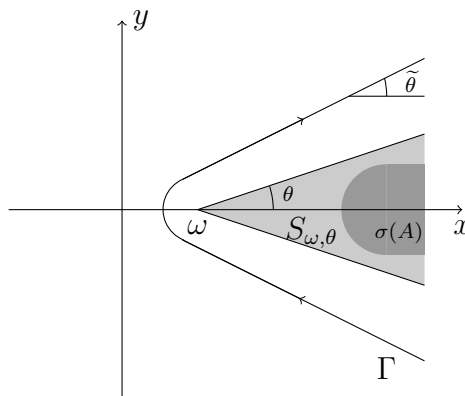

Example of contour Γ

We now give some results concerning the inhomogeneous initial value problem

$$\begin{cases} \frac{du}{dt}(t) + Au(t) = F(u(t), t), & t > 0, \\ u(0) = u_0, \end{cases} \quad (3.2.1)$$

where A is a sectorial operator in X and F satisfies the following assumption.

Hypothesis 3.2.5. F maps $X \times \mathbb{R}_+$ into X , $F(x, t)$ is locally Hölder continuous in t and locally Lipschitz in x on $X \times \mathbb{R}_+$. More precisely, if $(x_1, t_1) \in X \times \mathbb{R}_+$, there exists a neighbourhood $V \subset X \times \mathbb{R}_+$ of (x_1, t_1) such that for $(x, t) \in V$ and $(y, s) \in V$,

$$\|F(x, t) - F(y, s)\| \leq L(|t - s|^\vartheta + \|x - y\|),$$

for some constants $L > 0, \vartheta \in (0, 1]$.

Definition 3.2.6. A solution of the Cauchy problem (3.2.1) on $(0, T)$ is a continuous function $u : [0, T) \rightarrow X$ such that $u(0) = u_0$ and on $(0, T)$, we have $u(t) \in D(A)$, $\frac{du}{dt}(t)$ exists, $t \mapsto F(u(t), t)$ is locally Hölder continuous, $\int_0^\rho \|F(u(\cdot, t), t)\| dt < +\infty$ for some $\rho > 0$, and the differential equation (3.2.1) is satisfied.

The following theorem gives the local existence and uniqueness of solutions to (3.2.1).

Theorem 3.2.7. Assume that A is a sectorial operator and F satisfies Hypothesis 3.2.5, then for any $u_0 \in X$, there exists $T = T(u_0) > 0$ such that (3.2.1) has a unique solution u on $(0, T)$ with initial value $u(0) = u_0$.

An integral expression of this solution is given by Duhamel's formula :

$$u(t) = e^{-At}u_0 + \int_0^t e^{-A(t-s)}F(u(s), s)ds. \quad (3.2.2)$$

With more assumptions on F (given by Theorem 3.2.8), solutions are global in time.

Theorem 3.2.8. Assume A is a sectorial operator, F satisfies Hypothesis 3.2.5, and, for all $(x, t) \in X \times \mathbb{R}_+$,

$$\|F(x, t)\| \leq K(t)(1 + \|x\|),$$

for a continuous function K on \mathbb{R}_+ . Then, for any $u_0 \in X$, the unique solution u of (3.2.1) starting from u_0 remains bounded in X uniformly in $t > 0$. Consequently

$$u \in \mathcal{C}((0, +\infty), D(A)) \cap \mathcal{C}^1((0, +\infty), X).$$

Remark 3.2.9. From Lemma 3.3.2 of [53], if u is a solution to (3.2.1), then $u(x, \cdot)$ is locally Hölder continuous from \mathbb{R}_+ to X , uniformly in X . The proof of this fact uses the explicit expression of u given in (3.2.2) and the following estimates : if A is sectorial in X and $\Re(\sigma(A)) > a > 0$, then for any constant $\gamma \geq 0$, there exists $C_\gamma > 0$ such that

$$\|A^\gamma e^{-At}\| \leq C_\gamma t^{-\gamma} e^{-at}, \quad \text{for } t > 0,$$

and if $\gamma \in (0, 1)$, $x \in D(A^\gamma)$ and $t > 0$, there holds :

$$\|(e^{-At} - I)x\| \leq \gamma^{-1} C_{1-\gamma} t^\gamma \|A^\gamma x\|.$$

The last result concerning sectorial operators we will use, is the continuous dependence of the solutions, given in Theorem 3.4.1 of [53] :

Theorem 3.2.10. *Suppose A is a sectorial operator. Let $\{F_n(x, t), n \in \mathbb{N}\}$ be a sequence of functions defined on $X \times \mathbb{R}_+$ into X , each $F_n(x, t)$ locally Lipschitz in x , locally Hölder continuous in t , and such that*

$$F_0(x, t) = \lim_{n \rightarrow +\infty} F_n(x, t),$$

uniformly for (x, t) in a neighbourhood of any point of $X \times \mathbb{R}_+$. Let $t_0 > 0$, and u_n be the maximally defined solution of

$$\begin{cases} \frac{du_n}{dt}(t) + Au_n(t) = F_n(u_n(t), t), & t > t_0, \\ u_n(t_0) = u_{n,0}, \end{cases}$$

which exists on $(t_0, t_0 + T_n)$. If $\|u_{n,0} - u_{0,0}\|_X$ tends to 0 as n tends to $+\infty$, then $T_0 \geq \limsup_{n \rightarrow +\infty} T_n$ and

$$\|u_n(t) - u_0(t)\| \xrightarrow[n \rightarrow +\infty]{} 0,$$

uniformly on compact subintervals of $[t_0, t_0 + T_0)$.

3.3 Study of the operator A

From now on, we work in the Hilbert space $X = \{(v, u) \in L^2(\mathbb{R} \times \mathbb{R}_+) \times L^2(\mathbb{R})\}$. This framework will be sufficient for our results. Recall that the operator A is defined, for constants $\mu > 0$ and $k \geq 0$, by

$$A \begin{pmatrix} v \\ u \end{pmatrix} = \begin{pmatrix} -\Delta v \\ (-\partial_{xx})^\alpha u + \mu u - \gamma_0 v + ku \end{pmatrix}, \quad (3.3.1)$$

and, for $\tilde{\alpha} = \max(\alpha, 1/4)$, its domain is

$$D(A) = \{(v, u) \in H^2(\mathbb{R} \times \mathbb{R}_+) \times H^{2\tilde{\alpha}}(\mathbb{R}) \mid \gamma_1 v = \mu u - \gamma_0 v\} \subset X. \quad (3.3.2)$$

We first prove a lemma that studies zeroes of a function $P_{\tilde{k}}$ that depends on a parameter $\tilde{k} \geq 0$. This parameter will be equal to k when proving that the operator A is sectorial, and equal to $k + f'(0)$ when estimating from above the solution to the linearised problem at 0 associated to (3.1.1). Then, we prove the closedness of A and the density of its domain in X . This leads to the proof of the fact that A is a sectorial operator in X , with angle β_A that we can take in $(0, \frac{\pi}{2})$. Consequently, from Theorem 3.2.4, the semi group associated to A is analytic. At the end of this section, we study the particular action of A on x -independent couples, which will be needed in Chapter 4.

Let us make some comments on the regularity of u and v :

- The term $(-\partial_{xx})^\alpha u$ makes it natural to look for u in $H^{2\alpha}(\mathbb{R})$. However, when $\alpha \in (0, 1/4)$, we need more regularity than $H^{2\alpha}(\mathbb{R})$ on u due to the boundary condition $\gamma_1 v = \mu u - \gamma_0 v$. For such values of α , since $v \in H^2(\mathbb{R} \times \mathbb{R}_+)$, Theorem 3.2.1 shows that the boundary condition imposes $u \in H^{1/2}(\mathbb{R})$.
- The function v is expected to belong to $H^2(\mathbb{R} \times \mathbb{R}_+)$, which implies $\gamma_0 v \in H^{\frac{3}{2}}(\mathbb{R})$. By Sobolev embeddings, v is continuous on $\{(x, 0), x \in \mathbb{R}\}$. However, in this chapter, we keep the notation $\gamma_0 v$ to be consistent with the notation $\gamma_1 v$. In Chapter 4, to be consistent with the notations used in [19], we will denote by $v|_{y=0}$ the functions $\gamma_0 v$.

3.3.1 Location of zeroes

To determine the spectrum of A or to compute the solution to the linearised problem at 0 associated to (4.1.1), we will use the Fourier transform in the x variable of the system. Both computations reveal the importance of studying the location of the zeroes of the following function, defined for $\lambda \in \mathbb{C}$, $r \geq 0$ and $\tilde{k} \geq 0$ by :

$$P_{\tilde{k}}(\lambda, r) = (-\lambda + r^{2\alpha} + \mu + \tilde{k})(1 + \sqrt{-\lambda + r^2}) - \mu, \quad (3.3.3)$$

for $\alpha \in (0, 1)$, $\mu > 0$ and $\tilde{k} \geq 0$. In this expression, keep in mind that

- λ will be the integration variable that appears in the Laplace transform formula, given by Theorem 3.2.4,
- r will be the absolute value of the Fourier variable,
- \tilde{k} will be equal to k when determining the spectrum of A , and $k + f'(0)$ when computing the solution to the linearised problem at 0,
- μ is the exchange coefficient between the road and the field given by the model.

We also need to define by $r_{0, \tilde{k}} > 0$ the solution to

$$r_{0, \tilde{k}}^2 = r_{0, k}^{2\alpha} + \tilde{k}. \quad (3.3.4)$$

This quantity will be of particular interest when computing the integral given by the Laplace transform in Theorem 3.2.4.

Lemma 3.3.1. *Let $P_{\tilde{k}}$ and $r_{0,\tilde{k}}$ be defined respectively in (3.3.3) and (3.3.4). Then*

- if $r \in [0, r_{0,\tilde{k}})$ and $\lambda \in \mathbb{C}$, then $P_{\tilde{k}}(\lambda, r) \neq 0$,
- if $r \geq r_{0,\tilde{k}}$ and $\lambda \in \mathbb{C} \setminus \{\lambda \in \mathbb{R} \mid \lambda \geq r^{2\alpha} + \tilde{k}\}$, then $P_{\tilde{k}}(\lambda, r) \neq 0$.

Proof: Let $r \geq 0$ and $\lambda \in \mathbb{C}$ be such that $P_{\tilde{k}}(\lambda, r) = 0$. Taking the real and imaginary part in this equality, we have

$$\left(-\Re(\lambda) + r^{2\alpha} + \mu + \tilde{k}\right) (1 + \Re(z(\lambda, r))) + \Im(\lambda)\Im(z(\lambda, r)) - \mu = 0, \quad (3.3.5)$$

$$-\Im(\lambda) (1 + \Re(z(\lambda, r))) + \left(-\Re(\lambda) + r^{2\alpha} + \mu + \tilde{k}\right) \Im(z(\lambda, r)) = 0, \quad (3.3.6)$$

where $z(\lambda, r) = \sqrt{-\lambda + r^2}$.

We first prove that $-\lambda + r^2 \in \mathbb{R}_+$.

- If $-\lambda + r^2 < 0$ then (3.3.5) and (3.3.6) become

$$-\lambda + r^{2\alpha} + \mu + \tilde{k} = \mu \quad \text{and} \quad (-\lambda + r^{2\alpha} + \mu + \tilde{k})\sqrt{\lambda - r^2} = 0,$$

This imposes

$$\lambda = r^{2\alpha} + \tilde{k} \quad \text{and} \quad \lambda = r^2,$$

which is in contradiction with $-\lambda + r^2 < 0$.

- If $-\lambda + r^2 \in \mathbb{C} \setminus \mathbb{R}^-$, then $\Im(\lambda)$ and $\Im(\sqrt{-\lambda + r^2}) = \Im(z(\lambda, r))$ are of opposite sign. Thus equality (3.3.5) leads to

$$\left(-\Re(\lambda) + r^{2\alpha} + \mu + \tilde{k}\right) > 0,$$

and equality (3.3.6) implies $\Im(\lambda) = 0$. Consequently we have $-\lambda + r^2 \geq 0$.

We now prove that $r \geq r_{0,\tilde{k}}$ and $\lambda \geq r^{2\alpha} + \tilde{k}$. Since $-\lambda + r^2 \geq 0$, equality (3.3.5) becomes

$$\left(-\lambda + r^{2\alpha} + \mu + \tilde{k}\right) \left(1 + \sqrt{-\lambda + r^2}\right) = \mu.$$

This leads to

$$\lambda \geq r^{2\alpha} + \tilde{k}.$$

Finally we have

$$r^2 \geq \lambda \geq r^{2\alpha} + \tilde{k},$$

which is possible if and only if $r \geq r_{0,\tilde{k}}$. ■

3.3.2 Closedness of A and density of its domain

Lemma 3.3.2. *The operator A with domain $D(A)$ is a closed linear operator.*

Proof : For $n \in \mathbb{N}$, let $(v_n, u_n) \in D(A)$ and $(f, g) \in X$ such that there exist

$$\lim_{n \rightarrow +\infty} (v_n, u_n) = (v, u) \quad \text{in } X, \quad \text{and} \quad \lim_{n \rightarrow +\infty} A \begin{pmatrix} v_n \\ u_n \end{pmatrix} = \begin{pmatrix} f \\ g \end{pmatrix} \quad \text{in } X.$$

We have to prove that

$$(v, u) \in D(A), \quad \text{and} \quad A \begin{pmatrix} v \\ u \end{pmatrix} = \begin{pmatrix} f \\ g \end{pmatrix}.$$

First we prove that $(v, u) \in H^2(\mathbb{R} \times \mathbb{R}_+) \times H^{2\tilde{\alpha}}(\mathbb{R})$, by proving that $(v_n)_n$ and $(u_n)_n$ are Cauchy sequences respectively in $H^2(\mathbb{R} \times \mathbb{R}_+)$ and $H^{2\tilde{\alpha}}(\mathbb{R})$. Let us define for $n \in \mathbb{N}^*$,

$$\begin{pmatrix} f_n \\ g_n \end{pmatrix} := A \begin{pmatrix} v_n \\ u_n \end{pmatrix}.$$

For all $m \in \mathbb{N}$, $p \in \mathbb{N}$, the couple $(v_m - v_p, u_m - u_p)$ satisfies almost everywhere in $\mathbb{R} \times \mathbb{R}_+$ and in \mathbb{R} :

$$\begin{cases} -\Delta(v_m - v_p) = f_m - f_p, \\ (-\partial_{xx})^\alpha(u_m - u_p) + (\mu + k)(u_m - u_p) - \gamma_0(v_m - v_p) = g_m - g_p, \\ \gamma_1(v_m - v_p) = \mu(u_m - u_p) - \gamma_0(v_m - v_p). \end{cases} \quad (3.3.7)$$

We multiply the first equation of (3.3.7) by $v_m - v_p$ and integrate on $\mathbb{R} \times \mathbb{R}_+$ to get

$$\int_{\mathbb{R} \times \mathbb{R}_+} -\Delta(v_m - v_p)(v_m - v_p) dx dy = \int_{\mathbb{R} \times \mathbb{R}_+} (f_m - f_p)(v_m - v_p) dx dy. \quad (3.3.8)$$

For all $n \in \mathbb{N}$, the function v_n is in $H^2(\mathbb{R} \times \mathbb{R}_+)$, we can apply the Green's formula

$$\begin{aligned} \int_{\mathbb{R} \times \mathbb{R}_+} \Delta(v_m - v_p)(v_m - v_p) dx dy &= -\|\nabla(v_m - v_p)\|_{L^2(\mathbb{R} \times \mathbb{R}_+)}^2 \\ &\quad + \int_{\mathbb{R}} \gamma_0(v_m - v_p)\gamma_1(v_m - v_p) dx. \end{aligned} \quad (3.3.9)$$

We know that, for all $n \in \mathbb{N}$, (v_n, u_n) is in $D(A)$, that is why in (3.3.9) the function $\gamma_1(v_m - v_p)$ is replaced by $\mu(u_m - u_p) - \gamma_0(v_m - v_p)$. Inserting (3.3.9) in (3.3.8) we get

$$\begin{aligned} \|\nabla(v_m - v_p)\|_{L^2(\mathbb{R} \times \mathbb{R}_+)}^2 &- \mu \int_{\mathbb{R}} \gamma_0(v_m - v_p)(u_m - u_p) dx + \|\gamma_0(v_m - v_p)\|_{L^2(\mathbb{R})}^2 \\ &= \int_{\mathbb{R} \times \mathbb{R}_+} (f_m - f_p)(v_m - v_p) dx dy. \end{aligned} \quad (3.3.10)$$

This equality implies

$$\begin{aligned} \|\nabla(v_m - v_p)\|_{L^2(\mathbb{R} \times \mathbb{R}_+)}^2 &\leq \mu \|\gamma_0(v_m - v_p)\|_{L^2(\mathbb{R})} \| (u_m - u_p) \|_{L^2(\mathbb{R})} \\ &\quad + \|f_m - f_p\|_{L^2(\mathbb{R} \times \mathbb{R}_+)} \|v_m - v_p\|_{L^2(\mathbb{R} \times \mathbb{R}_+)}. \end{aligned}$$

Since the right hand side tends to 0 as m and p tend to $+\infty$, the sequence $(\nabla v_n)_n$ converges in $L^2(\mathbb{R} \times \mathbb{R}_+)$ to ∇v , which proves that $v \in H^1(\mathbb{R} \times \mathbb{R}_+)$. From (3.3.7), we also have

$$\|\Delta(v_m - v_p)\|_{L^2(\mathbb{R} \times \mathbb{R}_+)} = \|f_m - f_p\|_{L^2(\mathbb{R} \times \mathbb{R}_+)}.$$

The sequence $(\Delta v_n)_n$ converges in $L^2(\mathbb{R} \times \mathbb{R}_+)$ to Δv and consequently $v \in H^2(\mathbb{R} \times \mathbb{R}_+)$.

Then we prove that $(u_n)_n$ is a Cauchy sequence in $H^{2\tilde{\alpha}}(\mathbb{R})$, where $\tilde{\alpha} = \max(1/4, \alpha)$. We treat separately the cases $\alpha \in (0, 1/4)$ and $\alpha \in [1/4, 1)$.

- If $\alpha \in [1/4, 1)$, then $\tilde{\alpha} = \alpha$ and we use the following alternative definition of the space $H^{2\alpha}(\mathbb{R})$ via the Fourier transform

$$H^{2\alpha}(\mathbb{R}) = \left\{ u \in L^2(\mathbb{R}) \mid \int_{\mathbb{R}} (1 + |\xi|^2)^{2\alpha} |\widehat{u}(\xi)|^2 d\xi < +\infty \right\}.$$

Thus, using the Fourier transform of the operator $(-\partial_{xx})^\alpha$, Parseval's equality and the second equality of (3.3.7), we have

$$\begin{aligned} \|u_m - u_p\|_{H^{2\alpha}(\mathbb{R})}^2 &= \int_{\mathbb{R}} (1 + |\xi|^2)^{2\alpha} |\widehat{u}_m(\xi) - \widehat{u}_p(\xi)|^2 d\xi \\ &\leq C \int_{\mathbb{R}} (1 + |\xi|^{4\alpha}) |\widehat{u}_m(\xi) - \widehat{u}_p(\xi)|^2 d\xi \\ &\leq C \|u_m - u_p\|_{L^2(\mathbb{R})}^2 + C \|(-\partial_{xx})^\alpha(u_m - u_p)\|_{L^2(\mathbb{R})}^2 \\ &\leq C (\|u_m - u_p\|_{L^2(\mathbb{R})} + \|\gamma_0(v_m - v_p)\|_{L^2(\mathbb{R})} + \|g_m - g_p\|_{L^2(\mathbb{R})})^2. \end{aligned}$$

The right hand side tends to 0 as m and p tends to $+\infty$, which proves that

$$\lim_{n \rightarrow +\infty} u_n = u \in H^{2\alpha}(\mathbb{R}).$$

- If $\alpha \in (0, 1/4)$, then $\tilde{\alpha} = 1/4$. We use the continuity of the trace functions γ_0 and γ_1 , recalled in Theorem 3.2.1, and the third equality of (3.3.7) to get

$$\begin{aligned} \mu \|u_m - u_p\|_{H^{1/2}(\mathbb{R})} &\leq \|\gamma_0(v_m - v_p)\|_{H^{1/2}(\mathbb{R})} + \|\gamma_1(v_m - v_p)\|_{H^{1/2}(\mathbb{R})} \\ &\leq C_{tr} (\|v_m - v_p\|_{H^1(\mathbb{R} \times \mathbb{R}_+)} + \|v_m - v_p\|_{H^2(\mathbb{R} \times \mathbb{R}_+)}). \end{aligned}$$

Since $(v_n)_n$ is a Cauchy sequence in $H^2(\mathbb{R} \times \mathbb{R}_+)$, the right hand side tends to 0 as m and p tends to $+\infty$, which proves

$$\lim_{n \rightarrow +\infty} u_n = u \in H^{1/2}(\mathbb{R}).$$

We now prove $A(v, u)^t = (f, g)^t$ and the boundary condition for the limiting couple (v, u) . For $n \in \mathbb{N}$, the couple (v_n, u_n) satisfies, almost everywhere in the (x, y) -variable

$$\begin{cases} -\Delta v_n = f_n, & x \in \mathbb{R}, y > 0, \\ (-\partial_{xx})^\alpha u_n + \mu u_n - \gamma_0 v_n k u_n = g_n, & x \in \mathbb{R}, y = 0, \\ \gamma_1 v_n = \mu u_n - \gamma_0 v_n, & x \in \mathbb{R}, y = 0. \end{cases}$$

Once we know that $(v, u) \in H^2(\mathbb{R} \times \mathbb{R}_+) \times H^{2\tilde{\alpha}}(\mathbb{R})$, we can easily pass to the limit as n tends to $+\infty$ in each equation of this system, which concludes the proof. ■

Lemma 3.3.3. *The operator A with domain $D(A)$ is densely defined in X .*

Proof : Let (f, g) be in X . We prove the existence of a sequence (f_n, g_n) in $D(A)$ that converges to (f, g) in X as n tends to $+\infty$. From the density of $\mathcal{C}_c^\infty(\mathbb{R} \times \mathbb{R}_+)$ (respectively $\mathcal{C}_c^\infty(\mathbb{R})$) in $L^2(\mathbb{R} \times \mathbb{R}_+)$ (respectively $L^2(\mathbb{R})$), we get the existence of a sequence (f_n^1, g_n^1) in $\mathcal{C}_c^\infty(\mathbb{R} \times \mathbb{R}_+) \times \mathcal{C}_c^\infty(\mathbb{R})$ such that

$$f_n^1 \xrightarrow{n \rightarrow +\infty} f \text{ in } L^2(\mathbb{R} \times \mathbb{R}_+) \quad \text{and} \quad g_n^1 \xrightarrow{n \rightarrow +\infty} g \text{ in } L^2(\mathbb{R}). \quad (3.3.11)$$

The sequence (f_n^1, g_n^1) does not solve the problem since it is not in $D(A)$. A sequence $(f_n, g_n)_n$ that also satisfies the boundary condition $\gamma_1 f_n = \mu g_n - \gamma_0 f_n$ is constructed as follows : for all $n \in \mathbb{N}$, we take $g_n = g_n^1 \in H^{2\tilde{\alpha}}(\mathbb{R})$ and, for any sequence ε_n that tends to 0 as n tends to $+\infty$, we take, almost everywhere in the (x, y) -variable,

$$f_n(x, y) = \begin{cases} 0 & \text{if } x \in \mathbb{R}, y = 0, \\ ye^{-\frac{y^2}{(\varepsilon_n - y)^2}} \mu g_n(x) + e^{-\frac{(\varepsilon_n - y)^2}{y^2}} f_n^1(x, y) & \text{if } x \in \mathbb{R}, y \in (0, \varepsilon_n), \\ f_n^1(x, y) & \text{if } x \in \mathbb{R}, y \geq \varepsilon_n. \end{cases}$$

Thus, for all $n \in \mathbb{N}$, f_n is in $H^2(\mathbb{R} \times \mathbb{R}_+)$ and satisfies almost everywhere in \mathbb{R} :

$$\gamma_0 f_n = 0 \quad \text{and} \quad \gamma_1 f_n = -\partial_y f_n(\cdot, 0) = -\mu g_n.$$

For any $n \in \mathbb{N}$, the couple (f_n, g_n) is in $D(A)$. It remains to prove that

$$\|f_n - f\|_{L^2(\mathbb{R} \times \mathbb{R}_+)} \xrightarrow{n \rightarrow +\infty} 0.$$

We have

$$\begin{aligned} \|f_n - f\|_{L^2(\mathbb{R} \times \mathbb{R}_+)}^2 &\leq 2 \|f_n - f_n^1\|_{L^2(\mathbb{R} \times \mathbb{R}_+)}^2 + 2 \|f_n^1 - f\|_{L^2(\mathbb{R} \times \mathbb{R}_+)}^2 \\ &\leq 2 \int_{\mathbb{R}} \int_0^{\varepsilon_n} \left| y e^{-\frac{y^2}{(\varepsilon_n - y)^2}} \mu g_n(x) + e^{-\frac{(\varepsilon_n - y)^2}{y^2}} f_n^1(x, y) - f_n^1(x, y) \right|^2 dy dx \\ &\quad + 2 \|f_n^1 - f\|_{L^2(\mathbb{R} \times \mathbb{R}_+)}^2. \end{aligned}$$

The sequences ε_n, g_n and f_n^1 converges as n tends to $+\infty$, we can apply the dominated convergence theorem to get

$$\int_{\mathbb{R}} \int_0^{\varepsilon_n} \left| y e^{-\frac{y^2}{(\varepsilon_n - y)^2}} \mu g_n(x) + e^{-\frac{(\varepsilon_n - y)^2}{y^2}} f_n^1(x, y) - f_n^1(x, y) \right|^2 dy dx \xrightarrow{n \rightarrow +\infty} 0.$$

With this limit and (3.3.11), we conclude that $\|f_n - f\|_{L^2(\mathbb{R} \times \mathbb{R}_+)} \xrightarrow{n \rightarrow +\infty} 0$. ■

3.3.3 A is sectorial in X

Proposition 3.3.4. *The operator A defined in (3.3.1) with domain $D(A)$ given in (3.3.2) is sectorial in X , with parameters $\omega = 0$ and β_A any angle in $(0, \frac{\pi}{2})$.*

Due to Lemma 3.3.2 and Lemma 3.3.3, A is closed in X and its domain is dense in X . We now prove the existence of an angle $\beta_A > 0$ and a constant $M > 0$ such that both points of Definition 3.2.3 are satisfied with $\omega = 0$ and $\theta = \beta_A$. The proof reveals that the spectrum of A is contained in \mathbb{R} and consequently, it makes possible to choose β_A equal to any value of $(0, \frac{\pi}{2})$. From Theorem 3.2.4, the semi group associated to (3.1.1) is analytic on X and the Laplace transform is valid for problem (3.1.1).

1. The first point to be checked is $\rho(A) \supset \mathbb{C} \setminus S_{0, \beta_A}$. It is equivalent to prove that $\sigma(A) \subset S_{0, \beta_A}$. In fact, we prove that $\sigma(A) \subset S_{0, \beta}$, for any angle $\beta \in (0, \pi)$.

Let λ be in $\sigma(A)$. We have to study $\text{Ker}(A - \lambda I)$ and $\text{Im}(A - \lambda I)$. We first prove that it is sufficient to study the first set to get the result. Indeed, if A^* denotes the adjoint operator of A in X , then a simple computation using Green's formula gives that

$$\text{for any } \begin{pmatrix} v \\ u \end{pmatrix} \in X, \text{ with } \gamma_1 v = u - \gamma_0 v, \text{ we have } \begin{pmatrix} \mu v \\ u \end{pmatrix} \in D(A),$$

$$\text{and } A^* \begin{pmatrix} v \\ u \end{pmatrix} = \begin{pmatrix} \mu^{-1} & 0 \\ 0 & 1 \end{pmatrix} A \begin{pmatrix} \mu v \\ u \end{pmatrix}.$$

Consequently, since A is closed in X (see Lemma 3.3.2), we have

$$\operatorname{Im}(A - \lambda I) = \overline{\operatorname{Im}(A - \lambda I)} = \operatorname{Ker}(A^* - \lambda I)^\perp = \operatorname{Ker} \left((A - \lambda I) \begin{pmatrix} \mu & 0 \\ 0 & 1 \end{pmatrix} \right)^\perp.$$

Thus, we only have to prove that if $\operatorname{Ker}(A - \lambda I) \neq \{0\}$, then $\lambda \in S_{0,\beta}$, for any angle $\beta \in (0, \pi)$. In such a case, there exists (v_A, u_A) in $D(A)$, with $(v_A, u_A) \neq (0, 0)$, such that

$$A \begin{pmatrix} v_A \\ u_A \end{pmatrix} = \lambda \begin{pmatrix} v_A \\ u_A \end{pmatrix}.$$

In other words, (v_A, u_A) satisfies the following system, almost everywhere in the (x, y) -variable

$$\begin{cases} -\Delta v_A = \lambda v_A, & x \in \mathbb{R}, y > 0, \\ (-\partial_{xx})^\alpha u_A + \mu u_A - \gamma_0 v_A + k u_A = \lambda u_A, & x \in \mathbb{R}, y = 0, \\ \gamma_1 v_A = \mu u_A - \gamma_0 v_A & x \in \mathbb{R}, y = 0. \end{cases}$$

Taking the Fourier transform in the x -variable, we get, almost everywhere in the (x, y) -variable,

$$\begin{cases} -\partial_{yy} \widehat{v}_A = (\lambda - |\xi|^2) \widehat{v}_A, & \xi \in \mathbb{R}, y > 0, \\ \gamma_0 \widehat{v}_A = (-\lambda + |\xi|^{2\alpha} + \mu + k) \widehat{u}_A, & \xi \in \mathbb{R}, y = 0, \\ \gamma_1 \widehat{v}_A + \gamma_0 \widehat{v}_A = \mu \widehat{u}_A, & \xi \in \mathbb{R}, y = 0. \end{cases} \quad (3.3.12)$$

Recall that we are looking for a solution v_A that is in $H^2(\mathbb{R} \times \mathbb{R}_+)$. This imposes

$$\lambda - |\xi|^2 \notin \mathbb{R}_-.$$

The first equation of (3.3.12) gives, for almost every $\xi \in \mathbb{R}$ and almost every $y \geq 0$,

$$\widehat{v}_A(\xi, y) = \widehat{v}_A(\xi, 0) e^{-\sqrt{|\xi|^2 - \lambda} y}. \quad (3.3.13)$$

Once we have \widehat{v}_A , the third equation of (3.3.12) implies for almost every $\xi \in \mathbb{R}$

$$\gamma_0 \widehat{v}_A(\xi, 0) = \frac{\mu}{1 + \sqrt{|\xi|^2 - \lambda}} \widehat{u}_A(\xi). \quad (3.3.14)$$

Finally, for almost every $\xi \in \mathbb{R}$ the second equation of (3.3.12) leads to

$$\left(-\frac{\mu}{1 + \sqrt{|\xi|^2 - \lambda}} - \lambda + |\xi|^{2\alpha} + \mu + k \right) \widehat{u}_A(\xi) = 0. \quad (3.3.15)$$

With the definition of P_k given in (3.3.3), equality (3.3.15) can be written

$$P_k(\lambda, |\xi|) \widehat{u}_A(\xi) = 0, \quad \text{for almost every } \xi \in \mathbb{R}. \quad (3.3.16)$$

Let β be any positive constant in $(0, \pi)$. If $\lambda \in \mathbb{C} \setminus S_{0,\beta}$, then Lemma 3.3.1 implies for all $\xi \in \mathbb{R}$, $P_k(\lambda, |\xi|) \neq 0$. Thus, equation (3.3.16) gives $u_A \equiv 0$ in $L^2(\mathbb{R})$. Moreover, with (3.3.13) and (3.3.14), we conclude that $(v_A, u_A) \equiv (0, 0)$ in X , which is impossible since (v_A, u_A) is an eigenfunction for the operator A . Consequently, $\lambda \in S_{0,\beta}$, for any $\beta \in (0, \pi)$.

2. The second point to be checked is the existence of a constant $M > 0$ such that, for any $\beta \in (0, \frac{\pi}{2})$, the following resolvent estimate holds :

$$\|R(\lambda, A)\|_{\mathcal{L}(X)} \leq \frac{M}{|\lambda|}, \quad \text{for all } \lambda \in \mathbb{C} \setminus S_{0,\beta}, \lambda \neq 0.$$

Let $\lambda \in \mathbb{C} \setminus S_{0,\beta}$, with $\lambda \neq 0$, and $(g, h) \in X$. The quantity $(\lambda I - A)^{-1}(g, h)^t$ exists and is denoted by $(g_A, h_A) \in D(A)$. With these notations, we have

$$\begin{cases} \lambda g_A + \Delta g_A & = g \\ \lambda h_A - (-\partial_{xx})^\alpha h_A - \mu h_A + \gamma_0 g_A - k h_A & = h. \end{cases} \quad (3.3.17)$$

We want to prove there exists $M > 0$ such that for all $\lambda \in \mathbb{C} \setminus S_{0,\beta}$, $\lambda \neq 0$,

$$\|(g_A, h_A)\| \leq \frac{M}{|\lambda|} \|(g, h)\|. \quad (3.3.18)$$

We multiply the first equation of (3.3.17) by the conjugate $\overline{g_A}$ of g_A and integrate on $\mathbb{R} \times \mathbb{R}_+$ to get

$$\lambda \|g_A\|_{L^2(\mathbb{R} \times \mathbb{R}_+)}^2 + \int_{\mathbb{R} \times \mathbb{R}_+} \Delta g_A \overline{g_A} dx dy = \int_{\mathbb{R} \times \mathbb{R}_+} g \overline{g_A} dx dy. \quad (3.3.19)$$

Since $g_A \in H^2(\mathbb{R} \times \mathbb{R}_+)$, the Green's formula yields

$$\int_{\mathbb{R} \times \mathbb{R}_+} \Delta g_A \overline{g_A} dx dy = -\|\nabla g_A\|_{L^2(\mathbb{R} \times \mathbb{R}_+)}^2 + \int_{\mathbb{R}} \gamma_0 \overline{g_A} \gamma_1 g_A dx. \quad (3.3.20)$$

We know that (g_A, h_A) is in $D(A)$, consequently in (3.3.20) the function $\gamma_1 g_A$ is replaced by $\mu h_A - \gamma_0 g_A$. Inserting (3.3.20) in (3.3.19) we get

$$\lambda \|g_A\|_{L^2(\mathbb{R} \times \mathbb{R}_+)}^2 - \|\nabla g_A\|_{L^2(\mathbb{R} \times \mathbb{R}_+)}^2 + \mu \int_{\mathbb{R}} \gamma_0 \overline{g_A} h_A dx - \|\gamma_0 g_A\|_{L^2(\mathbb{R})}^2 = \int_{\mathbb{R} \times \mathbb{R}_+} g \overline{g_A} dx dy. \quad (3.3.21)$$

Then, we multiply the second equation of (3.3.17) by the conjugate \bar{h}_A of h_A and integrate on \mathbb{R} to get

$$\lambda \|h_A\|_{L^2(\mathbb{R})}^2 - \int_{\mathbb{R}} (-\partial_{xx})^\alpha h_A \bar{h}_A dx - (\mu + k) \|h_A\|_{L^2(\mathbb{R})}^2 + \int_{\mathbb{R}} \gamma_0 g_A \bar{h}_A dx = \int_{\mathbb{R}} h \bar{h}_A dx. \quad (3.3.22)$$

Recall that the term $\int_{\mathbb{R}} (-\partial_{xx})^\alpha h_A \bar{h}_A dx$ is proportional to $\|h_A\|_{\dot{H}^\alpha}$. Indeed, using the Parseval identity, we have

$$\int_{\mathbb{R}} (-\partial_{xx})^\alpha h_A \bar{h}_A dx = \int_{\mathbb{R}} |\xi|^{2\alpha} |h_A(\xi)|^2 d\xi = \frac{1}{2} \|h_A\|_{\dot{H}^\alpha}^2.$$

Consequently there holds

$$\lambda \|h_A\|_{L^2(\mathbb{R})}^2 - \frac{1}{2} \|h_A\|_{\dot{H}^\alpha}^2 - (\mu + k) \|h_A\|_{L^2(\mathbb{R})}^2 + \int_{\mathbb{R}} \gamma_0 g_A \bar{h}_A dx = \int_{\mathbb{R}} h \bar{h}_A dx. \quad (3.3.23)$$

Taking the real and imaginary parts in (3.3.21) and (3.3.23), we get the following system

$$\begin{cases} \Re(\lambda) \|g_A\|_{L^2(\mathbb{R} \times \mathbb{R}_+)}^2 - \|\nabla g_A\|_{L^2(\mathbb{R} \times \mathbb{R}_+)}^2 - \|\gamma_0 g_A\|_{L^2(\mathbb{R})}^2 + \mu \Re \left(\int_{\mathbb{R}} \gamma_0 \bar{g}_A h_A dx \right) \\ \qquad \qquad \qquad = \Re \left(\int_{\mathbb{R} \times \mathbb{R}_+} g \bar{g}_A dx dy \right) \\ \Im(\lambda) \|g_A\|_{L^2(\mathbb{R} \times \mathbb{R}_+)}^2 + \mu \Im \left(\int_{\mathbb{R}} \gamma_0 \bar{g}_A h_A dx \right) = \Im \left(\int_{\mathbb{R} \times \mathbb{R}_+} g \bar{g}_A dx dy \right) \\ \Re(\lambda) \|h_A\|_{L^2(\mathbb{R})}^2 - \frac{1}{2} \|h_A\|_{\dot{H}^\alpha}^2 - (\mu + k) \|h_A\|_{L^2(\mathbb{R})}^2 + \Re \left(\int_{\mathbb{R}} \gamma_0 g_A \bar{h}_A dx \right) \\ \qquad \qquad \qquad = \Re \left(\int_{\mathbb{R}} h \bar{h}_A dx \right) \\ \Im(\lambda) \|h_A\|_{L^2(\mathbb{R})}^2 + \Im \left(\int_{\mathbb{R}} \gamma_0 g_A \bar{h}_A dx \right) = \Im \left(\int_{\mathbb{R}} h \bar{h}_A dx \right). \end{cases} \quad (3.3.24)$$

To get the estimate (3.3.18) for $\lambda \in \mathbb{C} \setminus S_{0,\beta}$, $\lambda \neq 0$, we define $a_1 = \max(2\mu, 2\sqrt{2\mu})$ and $a_2 \geq \max(2\mu, 4\sqrt{\mu}, 1)$ large enough so that

$$\text{for all } x \geq a_2, \quad x \geq 8\sqrt{\mu}(1 + \sqrt{2 \tan(\beta)^{-1} x}). \quad (3.3.25)$$

We split $\mathbb{C} \setminus S_{0,\beta}$ into four areas as follows :

- **Area 1** corresponds to $\left\{ \lambda \in \mathbb{C} \mid \Re(\lambda) \leq -a_1, |\Im(\lambda)| \leq -\frac{a_2}{a_1} \Re(\lambda) \right\}$,
- **Area 2** corresponds to $\left\{ \lambda \in \mathbb{C} \mid -\frac{a_1}{a_2} |\Im(\lambda)| \leq \Re(\lambda) \leq 0, |\Im(\lambda)| \geq a_2 \right\}$,

- **Area 3** corresponds to $\{\lambda \in \mathbb{C} \mid 0 \leq \tan \beta \Re(\lambda) \leq |\Im(\lambda)|, |\Im(\lambda)| \geq a_2\}$,
- **Area 4** corresponds to $\left\{ \lambda \in \mathbb{C} \mid -a_1 \leq \Re \lambda \leq \frac{|\Im(\lambda)|}{\tan \beta}, |\Im(\lambda)| \leq a_2 \right\}$.

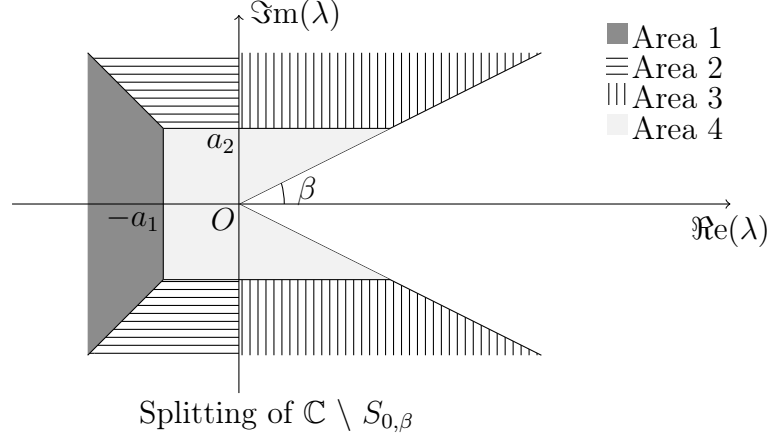

- **Area 1** : We have

$$|\Im(\lambda)| + |\Re(\lambda)| \leq \left(1 + \frac{a_2}{a_1}\right) |\Re(\lambda)|.$$

Thus, to prove (3.3.18), it is sufficient to prove the existence of a constant $M_1 > 0$ such that

$$|\Re(\lambda)| \left(\|g_A\|_{L^2(\mathbb{R} \times \mathbb{R}_+)} + \|h_A\|_{L^2(\mathbb{R})} \right) \leq M_1 \left(\|g\|_{L^2(\mathbb{R} \times \mathbb{R}_+)} + \|h\|_{L^2(\mathbb{R})} \right). \quad (3.3.26)$$

The first inequality in (3.3.24) gives

$$|\Re \lambda| \|g_A\|_{L^2(\mathbb{R} \times \mathbb{R}_+)}^2 \leq \mu \|\gamma_0 g_A\|_{L^2(\mathbb{R})} \|h_A\|_{L^2(\mathbb{R})} + \|g\|_{L^2(\mathbb{R} \times \mathbb{R}_+)} \|g_A\|_{L^2(\mathbb{R} \times \mathbb{R}_+)},$$

which leads to

$$\frac{|\Re \lambda|}{2} \|g_A\|_{L^2(\mathbb{R} \times \mathbb{R}_+)}^2 \leq \mu \|\gamma_0 g_A\|_{L^2(\mathbb{R})} \|h_A\|_{L^2(\mathbb{R})} + \frac{1}{2|\Re \lambda|} \|g\|_{L^2(\mathbb{R} \times \mathbb{R}_+)}^2. \quad (3.3.27)$$

We now have to estimate $\|h_A\|_{L^2(\mathbb{R})}$ and $\|\gamma_0 g_A\|_{L^2(\mathbb{R})}$. We use the third equation of (3.3.24) to get

$$|\Re \lambda| \|h_A\|_{L^2(\mathbb{R})} \leq \|h\|_{L^2(\mathbb{R})} + \|\gamma_0 g_A\|_{L^2(\mathbb{R})}. \quad (3.3.28)$$

Since $\Re(\lambda) \leq 0$ in this area, the first equation of (3.3.24) leads to

$$\begin{aligned} 2 \|\gamma_0 g_A\|_{L^2(\mathbb{R})}^2 &\leq 2\mu \|\gamma_0 g_A\|_{L^2(\mathbb{R})} \|h_A\|_{L^2(\mathbb{R})} + 2 \|g\|_{L^2(\mathbb{R} \times \mathbb{R}_+)} \|g_A\|_{L^2(\mathbb{R} \times \mathbb{R}_+)} \\ &\leq \|\gamma_0 g_A\|_{L^2(\mathbb{R})}^2 + \mu^2 \|h_A\|_{L^2(\mathbb{R})}^2 + \|g_A\|_{L^2(\mathbb{R} \times \mathbb{R}_+)}^2 + \|g\|_{L^2(\mathbb{R} \times \mathbb{R}_+)}^2, \end{aligned}$$

which proves

$$\|\gamma_0 g_A\|_{L^2(\mathbb{R})}^2 \leq \mu \|h_A\|_{L^2(\mathbb{R})}^2 + \|g_A\|_{L^2(\mathbb{R} \times \mathbb{R}_+)}^2 + \|g\|_{L^2(\mathbb{R} \times \mathbb{R}_+)}^2. \quad (3.3.29)$$

Finally with (3.3.27), (3.3.28) and (3.3.29), we have for $\Re \lambda \leq -a_1$:

$$\begin{aligned} \frac{|\Re \lambda|}{2} \|g_A\|_{L^2(\mathbb{R} \times \mathbb{R}_+)}^2 &\leq \frac{\mu \|\gamma_0 g_A\|_{L^2(\mathbb{R})}}{|\Re \lambda|} \left(\|h\|_{L^2(\mathbb{R})} + \|\gamma_0 g_A\|_{L^2(\mathbb{R})} \right) + \frac{\|g\|_{L^2(\mathbb{R} \times \mathbb{R}_+)}^2}{2 |\Re \lambda|} \\ &\leq \frac{\max(\mu, 1)}{2 |\Re \lambda|} \left(\|g\|_{L^2(\mathbb{R} \times \mathbb{R}_+)} + \|h\|_{L^2(\mathbb{R})} \right)^2 + \frac{2\mu \|\gamma_0 g_A\|_{L^2(\mathbb{R})}^2}{|\Re \lambda|} \\ &\leq \frac{\max(\mu, 1)}{2 |\Re \lambda|} \left(\|g\|_{L^2(\mathbb{R} \times \mathbb{R}_+)} + \|h\|_{L^2(\mathbb{R})} \right)^2 \\ &\quad + \frac{2\mu}{|\Re \lambda|} \left(\|g_A\|_{L^2(\mathbb{R} \times \mathbb{R}_+)}^2 + \mu \|h\|_{L^2(\mathbb{R})}^2 + \|g\|_{L^2(\mathbb{R} \times \mathbb{R}_+)}^2 \right). \end{aligned}$$

We conclude that

$$\begin{aligned} \frac{|\Re \lambda|}{2} \|g_A\|_{L^2(\mathbb{R} \times \mathbb{R}_+)} &\leq \sqrt{\frac{|\Re \lambda|^2}{2} - 2\mu \|g_A\|_{L^2(\mathbb{R} \times \mathbb{R}_+)}} \\ &\leq 2 \max(\mu, 1) \left(\|g\|_{L^2(\mathbb{R} \times \mathbb{R}_+)} + \|h\|_{L^2(\mathbb{R})} \right). \end{aligned} \quad (3.3.30)$$

With (3.3.28) and (3.3.29), we also have

$$\left(1 - \frac{\mu}{|\Re \lambda|} \right) \|\gamma_0 g_A\|_{L^2(\mathbb{R})} \leq \|g_A\|_{L^2(\mathbb{R} \times \mathbb{R}_+)} + \|g\|_{L^2(\mathbb{R} \times \mathbb{R}_+)} + \frac{\mu \|h\|_{L^2(\mathbb{R})}}{|\Re \lambda|}. \quad (3.3.31)$$

Finally the estimate of $|\Re(\lambda)| \|h_A\|_{L^2(\mathbb{R})}$ is obtained with (3.3.28) and (3.3.31) as follows

$$\begin{aligned} \frac{|\Re \lambda|}{2} \|h_A\|_{L^2(\mathbb{R})} &\leq \|h\|_{L^2(\mathbb{R})} + \left(1 - \frac{\mu}{|\Re \lambda|} \right) \|\gamma_0 g_A\|_{L^2(\mathbb{R})} \\ &\leq \|g_A\|_{L^2(\mathbb{R} \times \mathbb{R}_+)} + \|g\|_{L^2(\mathbb{R} \times \mathbb{R}_+)} + \left(1 + \frac{\mu}{|\Re \lambda|} \right) \|h\|_{L^2(\mathbb{R})} \\ &\leq \left(4 \max(\mu, 1) + 1 + \frac{\mu}{|\Re \lambda|} \right) \left(\|g\|_{L^2(\mathbb{R} \times \mathbb{R}_+)} + \|h\|_{L^2(\mathbb{R})} \right). \end{aligned}$$

Thus setting $M_1 := (4 \max(\mu, 1) + 1 + \mu a_1^{-1}) > 0$, from this inequality and (3.3.30), we have for $\Re \lambda \leq -a_1$:

$$|\Re \lambda| \left(\|g_A\|_{L^2(\mathbb{R} \times \mathbb{R}_+)} + \|h_A\|_{L^2(\mathbb{R})} \right) \leq M_1 \left(\|g\|_{L^2(\mathbb{R} \times \mathbb{R}_+)} + \|h\|_{L^2(\mathbb{R})} \right).$$

• **Areas 2 and 3** : We will see that it is sufficient to prove the existence of a constant $M_2 > 0$ such that

$$|\Im(\lambda)| \left(\|g_A\|_{L^2(\mathbb{R} \times \mathbb{R}_+)} + \|h_A\|_{L^2(\mathbb{R})} \right) \leq M_2 \left(\|g\|_{L^2(\mathbb{R} \times \mathbb{R}_+)} + \|h\|_{L^2(\mathbb{R})} \right). \quad (3.3.32)$$

With the second and fourth equalities of (3.3.24) and the fact that

$$\Im \left(\int_{\mathbb{R}} \gamma_0 g_A \bar{h}_A dx \right) = -\Im \left(\int_{\mathbb{R}} \gamma_0 \bar{g}_A h_A dx \right),$$

we have

$$\Im(\lambda) \left(\mu \|h_A\|_{L^2(\mathbb{R})}^2 + \|g_A\|_{L^2(\mathbb{R} \times \mathbb{R}_+)}^2 \right) = \Im \left(\int_{\mathbb{R} \times \mathbb{R}_+} g \bar{g} dx dy + \mu \int_{\mathbb{R}} h \bar{h} dx \right).$$

This implies

$$\begin{aligned} |\Im(\lambda)| \|g_A\|_{L^2(\mathbb{R} \times \mathbb{R}_+)}^2 &\leq \|g\|_{L^2(\mathbb{R} \times \mathbb{R}_+)} \|g_A\|_{L^2(\mathbb{R} \times \mathbb{R}_+)} \\ &\quad + \mu \|h\|_{L^2(\mathbb{R})} \|h_A\|_{L^2(\mathbb{R})} + \mu |\Im(\lambda)| \|h_A\|_{L^2(\mathbb{R})}^2 \\ &\leq \frac{\|g\|_{L^2(\mathbb{R} \times \mathbb{R}_+)}^2}{2 |\Im(\lambda)|} + \frac{|\Im(\lambda)|}{2} \|g_A\|_{L^2(\mathbb{R} \times \mathbb{R}_+)}^2 \\ &\quad + \mu \|h\|_{L^2(\mathbb{R})} \|h_A\|_{L^2(\mathbb{R})} + \mu |\Im(\lambda)| \|h_A\|_{L^2(\mathbb{R})}^2, \end{aligned}$$

and thus we have

$$\begin{aligned} |\Im(\lambda)| \|g_A\|_{L^2(\mathbb{R} \times \mathbb{R}_+)}^2 &\leq \frac{\|g\|_{L^2(\mathbb{R} \times \mathbb{R}_+)}^2}{|\Im(\lambda)|} + 2\mu \left(\|h\|_{L^2(\mathbb{R})} \|h_A\|_{L^2(\mathbb{R})} \right. \\ &\quad \left. + |\Im(\lambda)| \|h_A\|_{L^2(\mathbb{R})}^2 \right). \end{aligned} \quad (3.3.33)$$

To prove (3.3.18), we need to get an upper bound to $\|h_A\|_{L^2(\mathbb{R})}$ proportional to $\frac{1}{|\Im(\lambda)|}$. With the fourth equation of (3.3.24) we have

$$|\Im(\lambda)| \|h_A\|_{L^2(\mathbb{R})} \leq \|h\|_{L^2(\mathbb{R})} + \|\gamma_0 g_A\|_{L^2(\mathbb{R})}. \quad (3.3.34)$$

It remains to get an estimate of $\|\gamma_0 g_A\|_{L^2(\mathbb{R})}$.

– In the area 2, where $-\frac{a_1}{a_2} |\Im(\lambda)| \leq \Re(\lambda) \leq 0$, the first equation of (3.3.24) leads to

$$\begin{aligned} 2 \|\gamma_0 g_A\|_{L^2(\mathbb{R})}^2 &\leq 2\mu \|\gamma_0 g_A\|_{L^2(\mathbb{R})} \|h_A\|_{L^2(\mathbb{R})} + 2 \|g\|_{L^2(\mathbb{R} \times \mathbb{R}_+)} \|g_A\|_{L^2(\mathbb{R} \times \mathbb{R}_+)} \\ &\leq \|\gamma_0 g_A\|_{L^2(\mathbb{R})}^2 + \mu^2 \|h_A\|_{L^2(\mathbb{R})}^2 + \|g_A\|_{L^2(\mathbb{R} \times \mathbb{R}_+)}^2 + \|g\|_{L^2(\mathbb{R} \times \mathbb{R}_+)}^2, \end{aligned}$$

which proves

$$\|\gamma_0 g_A\|_{L^2(\mathbb{R})} \leq \mu \|h_A\|_{L^2(\mathbb{R})} + \|g_A\|_{L^2(\mathbb{R} \times \mathbb{R}_+)} + \|g\|_{L^2(\mathbb{R} \times \mathbb{R}_+)}. \quad (3.3.35)$$

With (3.3.34) we obtain

$$(|\Im(\lambda)| - \mu) \|h_A\|_{L^2(\mathbb{R})} \leq \|h\|_{L^2(\mathbb{R})} + \|g_A\|_{L^2(\mathbb{R} \times \mathbb{R}_+)} + \|g\|_{L^2(\mathbb{R} \times \mathbb{R}_+)}. \quad (3.3.36)$$

Then (3.3.33) with (3.3.36) gives for $|\Im(\lambda)| \geq a_2$

$$\begin{aligned} \frac{|\Im(\lambda)|^2}{2} \|g_A\|_{L^2(\mathbb{R} \times \mathbb{R}_+)}^2 &\leq |\Im(\lambda)| (|\Im(\lambda)| - \mu) \|g_A\|_{L^2(\mathbb{R} \times \mathbb{R}_+)}^2 \\ &\leq \|g\|_{L^2(\mathbb{R} \times \mathbb{R}_+)}^2 + 2\mu \|h\|_{L^2(\mathbb{R})} (|\Im(\lambda)| - \mu) \|h_A\|_{L^2(\mathbb{R})} \\ &\quad + 4\mu \left(\|h\|_{L^2(\mathbb{R})} + \|g_A\|_{L^2(\mathbb{R} \times \mathbb{R}_+)} + \|g\|_{L^2(\mathbb{R} \times \mathbb{R}_+)} \right)^2 \\ &\leq C \left(\|g\|_{L^2(\mathbb{R} \times \mathbb{R}_+)}^2 + \|h\|_{L^2(\mathbb{R})}^2 \right) + 8\mu \|g_A\|_{L^2(\mathbb{R} \times \mathbb{R}_+)}^2 \\ &\quad + 2\mu \|h\|_{L^2(\mathbb{R})} \|g_A\|_{L^2(\mathbb{R} \times \mathbb{R}_+)} \\ &\leq C \left(\|g\|_{L^2(\mathbb{R} \times \mathbb{R}_+)}^2 + \|h\|_{L^2(\mathbb{R})}^2 \right) + 8\mu \|g_A\|_{L^2(\mathbb{R} \times \mathbb{R}_+)}^2 \\ &\quad + \frac{4\mu^2 \|h\|_{L^2(\mathbb{R})}^2}{|\Im(\lambda)|^2} + \frac{|\Im(\lambda)|^2}{4} \|g_A\|_{L^2(\mathbb{R} \times \mathbb{R}_+)}^2, \end{aligned}$$

where $C > 0$ is a constant only depending on μ . This inequality and (3.3.36) give the existence of a constant $M_2 > 0$ depending only on μ such that

$$|\Im(\lambda)| \left(\|g_A\|_{L^2(\mathbb{R} \times \mathbb{R}_+)} + \|h_A\|_{L^2(\mathbb{R})} \right) \leq M_2 \left(\|g\|_{L^2(\mathbb{R} \times \mathbb{R}_+)} + \|h\|_{L^2(\mathbb{R})} \right).$$

Thus, equality (3.3.18) is proved, since in this area

$$|\Im(\lambda)| + |\Re(\lambda)| \leq \left(1 + \frac{a_1}{a_2} \right) |\Im(\lambda)|.$$

- In the area 3, where $0 \leq \tan \beta \Re(\lambda) \leq |\Im(\lambda)|$, the first equation of (3.3.24) leads to

$$\begin{aligned} \|\gamma_0 g_A\|_{L^2(\mathbb{R})}^2 &\leq |\Re(\lambda)| \|g_A\|_{L^2(\mathbb{R} \times \mathbb{R}_+)}^2 + \mu \|\gamma_0 g_A\|_{L^2(\mathbb{R})} \|h_A\|_{L^2(\mathbb{R})} \\ &\quad + \|g\|_{L^2(\mathbb{R} \times \mathbb{R}_+)} \|g_A\|_{L^2(\mathbb{R} \times \mathbb{R}_+)} \\ &\leq |\Re(\lambda)| \|g_A\|_{L^2(\mathbb{R} \times \mathbb{R}_+)}^2 + \frac{1}{2} \|\gamma_0 g_A\|_{L^2(\mathbb{R})}^2 + \frac{1}{2} \mu^2 \|h_A\|_{L^2(\mathbb{R})}^2 \\ &\quad + \frac{1}{2} \|g_A\|_{L^2(\mathbb{R} \times \mathbb{R}_+)}^2 + \frac{1}{2} \|g\|_{L^2(\mathbb{R} \times \mathbb{R}_+)}^2, \end{aligned}$$

which proves the following estimate

$$\|\gamma_0 g_A\|_{L^2(\mathbb{R})} \leq \left(\sqrt{\frac{2|\Im m(\lambda)|}{\tan \beta}} + 1 \right) \|g_A\|_{L^2(\mathbb{R} \times \mathbb{R}_+)} + \mu \|h_A\|_{L^2(\mathbb{R})} + \|g\|_{L^2(\mathbb{R} \times \mathbb{R}_+)}.$$

The estimate (3.3.34), that was proved in areas 2 and 3, implies

$$\begin{aligned} (|\Im m(\lambda)| - \mu) \|h_A\|_{L^2(\mathbb{R})} &\leq \left(\sqrt{2(\tan \beta)^{-1} |\Im m(\lambda)|} + 1 \right) \|g_A\|_{L^2(\mathbb{R} \times \mathbb{R}_+)} \\ &\quad + \|h\|_{L^2(\mathbb{R})} + \|g\|_{L^2(\mathbb{R} \times \mathbb{R}_+)}. \end{aligned} \quad (3.3.37)$$

Thus (3.3.33), (3.3.37) and (3.3.25) give for $|\Im m(\lambda)| \geq a_2$

$$\begin{aligned} \frac{|\Im m(\lambda)|^2}{2} \|g_A\|_{L^2(\mathbb{R} \times \mathbb{R}_+)}^2 &\leq |\Im m(\lambda)| (|\Im m(\lambda)| - \mu) \|g_A\|_{L^2(\mathbb{R} \times \mathbb{R}_+)}^2 \\ &\leq \|g\|_{L^2(\mathbb{R} \times \mathbb{R}_+)}^2 + 2\mu \|h\|_{L^2(\mathbb{R})} (|\Im m(\lambda)| - \mu) \|h_A\|_{L^2(\mathbb{R})} + 4\mu \left[\|h\|_{L^2(\mathbb{R})} \right. \\ &\quad \left. + \|g\|_{L^2(\mathbb{R} \times \mathbb{R}_+)} + \left(\sqrt{\frac{2|\Im m(\lambda)|}{\tan \beta}} + 1 \right) \|g_A\|_{L^2(\mathbb{R} \times \mathbb{R}_+)} \right]^2 \\ &\leq C \left(\|g\|_{L^2(\mathbb{R} \times \mathbb{R}_+)} + \|h\|_{L^2(\mathbb{R})} \right)^2 + 8\mu \left(\sqrt{\frac{2|\Im m(\lambda)|}{\tan \beta}} + 1 \right)^2 \|g_A\|_{L^2(\mathbb{R} \times \mathbb{R}_+)}^2 \\ &\quad + 2\mu \left(\sqrt{\frac{2|\Im m(\lambda)|}{\tan \beta}} + 1 \right) \|h\|_{L^2(\mathbb{R})} \|g_A\|_{L^2(\mathbb{R} \times \mathbb{R}_+)} \\ &\leq C \left(\|g\|_{L^2(\mathbb{R} \times \mathbb{R}_+)} + \|h\|_{L^2(\mathbb{R})} \right)^2 + \frac{3|\Im m(\lambda)|^2}{8} \|g_A\|_{L^2(\mathbb{R} \times \mathbb{R}_+)}^2, \end{aligned}$$

where $C > 0$ is a constant only depending on μ and β . Consequently, this inequality and (3.3.37) give the existence a constant $M_2 > 0$ depending only on μ and β such that

$$|\Im m(\lambda)| (\|g_A\|_{L^2(\mathbb{R} \times \mathbb{R}_+)} + \|h_A\|_{L^2(\mathbb{R})}) \leq M_2 (\|g\|_{L^2(\mathbb{R} \times \mathbb{R}_+)} + \|h\|_{L^2(\mathbb{R})}).$$

Thus, equality (3.3.18) is proved, since in this area

$$|\Im m(\lambda)| + |\Re e(\lambda)| \leq (1 + \tan \beta^{-1}) |\Im m(\lambda)|.$$

- **Area 4** : In this compact zone, the result comes from the continuity of $\lambda \mapsto R(\lambda, A)$.

3.3.4 Particular case : x -independent solutions

To use the proof done in [17] to study the convergence to a stationary state, and to prove Theorem 4.1.3, we will have to consider solutions starting from x -independent initial conditions. In this section, the framework is a little different than in sections 3.3.2 and 3.3.3, but we can adapt the proofs to get similar results.

We consider the Banach space $X_{\natural} = \{(v_{\natural}, u_{\natural}) \in L^2(\mathbb{R}_+) \times \mathbb{R}\}$. For any couple $(v_{\natural}, u_{\natural}) \in X_{\natural}$, the operator A defined in (3.3.1) becomes

$$A \begin{pmatrix} v_{\natural} \\ u_{\natural} \end{pmatrix} = \begin{pmatrix} -\partial_{yy} v_{\natural} \\ \mu u_{\natural} - \gamma_0 v_{\natural} + k u_{\natural} \end{pmatrix}, \quad (3.3.38)$$

where $\mu > 0$, $k \geq 0$ and with domain

$$D_{\natural}(A) = \{(v_{\natural}, u_{\natural}) \in H^2(\mathbb{R}_+) \times \mathbb{R} \mid \gamma_1 v_{\natural} = \mu u_{\natural} - \gamma_0 v_{\natural}\} \subset X_{\natural}. \quad (3.3.39)$$

The closedness of A and the density of $D(A)$ are obtained easily, adapting the proofs of Lemma 3.3.2 and Lemma 3.3.3. We can also use the proof of Proposition 3.3.4 to show that A , with its domain $D_{\natural}(A)$, is a sectorial operator in X_{\natural} with the same angle $\beta_A \in (0, \frac{\pi}{2})$.

3.4 Problem (3.1.1) : existence, regularity, comparison principle

3.4.1 Existence and regularity of the solution to (3.1.1)

Recall that problem (3.1.1) can be written

$$\partial_t W + AW = F(W), \quad \text{where } W = \begin{pmatrix} v \\ u \end{pmatrix}, \quad F \begin{pmatrix} v \\ u \end{pmatrix} = \begin{pmatrix} f(v) \\ 0 \end{pmatrix}, \quad (3.4.1)$$

with a source term f of class $\mathcal{C}^\infty(\mathbb{R})$. The function F satisfies the assumptions of Theorem 3.2.7 and Theorem 3.2.8, which gives the existence and uniqueness of the global solution (v, u) to (3.1.1) starting from $(v_0, u_0) \in X$. Thus we have

$$(v, u) \in \mathcal{C}((0, +\infty), H^2(\mathbb{R} \times \mathbb{R}_+) \times H^{2\tilde{\alpha}}(\mathbb{R})) \cap \mathcal{C}^1((0, +\infty), L^2(\mathbb{R} \times \mathbb{R}_+) \times L^2(\mathbb{R})), \quad (3.4.2)$$

where $\tilde{\alpha} = \max(\frac{1}{4}, \alpha)$. From now on, we consider $\alpha \in (\frac{1}{4}, 1)$ and prove that

$$(v, u) \in \mathcal{C}^\infty(\mathbb{R} \times \mathbb{R}_+ \times \mathbb{R}_+^*) \times \mathcal{C}^\infty(\mathbb{R} \times \mathbb{R}_+^*).$$

We will explain, in the following **Result 1**, why we do not consider the case $\alpha \in (0, \frac{1}{4}]$.

This regularity is obtained by induction, proving the existence of a constant $\delta \in (0, 1)$ such that for all $T > 0$, for any constant $\varepsilon \in (0, T)$ and for all $n \in \mathbb{N}$:

$$v \in \mathcal{C}^{n+\delta, \frac{n+\delta}{2}}(\mathbb{R} \times \mathbb{R}_+ \times (\varepsilon_{2n}, T]) \quad \text{and} \quad u \in \mathcal{C}^{n+\delta, \frac{n+\delta}{2}}(\mathbb{R} \times (\varepsilon_{2n}, T]), \quad (3.4.3)$$

where

$$\varepsilon_{2n} = \sum_{j=1}^{2n} 2^{-j} \varepsilon \xrightarrow{n \rightarrow +\infty} \varepsilon.$$

We will use the following results :

Result 1 : The Sobolev embeddings given in [2] and [73] (for example) lead to :

- $H^2(\mathbb{R} \times \mathbb{R}_+) \subset \mathcal{C}^\lambda(\mathbb{R} \times \mathbb{R}_+)$, for all $\lambda \in (0, 1)$,
- for $\alpha \in (\frac{1}{4}, 1)$: $H^{2\alpha}(\mathbb{R}) \subset \mathcal{C}^{2\alpha-\frac{1}{2}}(\mathbb{R})$.

In the particular case $\alpha \in (0, \frac{1}{4}]$, the density u belongs to $H^{\frac{1}{2}}(\mathbb{R})$ and is not included in a Hölder space. With this framework, we can not have more regularity on u for $\alpha \in (0, \frac{1}{4}]$.

Result 2 : Set $t_0 > 0$, $T > t_0$, $l > 0$, and consider two functions $g \in \mathcal{C}^{l, \frac{l}{2}}(\mathbb{R} \times \mathbb{R}_+ \times [t_0, T])$ and $u_1 \in \mathcal{C}^{1+l, \frac{1+l}{2}}(\mathbb{R} \times [t_0, T])$. Let v_1 be the solution to

$$\begin{cases} \partial_t v_1 - \Delta v_1 = g, & x \in \mathbb{R}, y > 0, t > t_0, \\ -\partial_y v_1 + v_1 = \mu u_1, & x \in \mathbb{R}, y = 0, t > t_0, \end{cases}$$

starting from $v_1(\cdot, \cdot, t_0) \in \mathcal{C}^{l+2}(\mathbb{R} \times \mathbb{R}_+)$, and satisfying the following compatibility conditions of order $m_1 := \lfloor \frac{l+1}{2} \rfloor$:

$$\partial_t^{(m)}(-\partial_y v_1 + v_1)(\cdot, \cdot, t_0) = \mu \partial_t^{(m)} u_1(\cdot, t_0), \quad \text{for all } m \in \llbracket 0, m_1 \rrbracket.$$

Then, from Theorem 5.3 in [63], we have

$$v_1 \in \mathcal{C}^{l+2, \frac{l}{2}+1}(\mathbb{R} \times \mathbb{R}_+ \times [t_0, T]).$$

With these two results, we can prove (3.4.3).

Let $T > 0$, $\varepsilon \in (0, T)$ and $\varepsilon_i = \sum_{j=1}^i 2^{-j} \varepsilon$.

- Case $n = 0$: This case gives a general fact concerning the Hölder regularity in space and time for the solution to (3.4.1), for any nonlinearities that satisfy Hypothesis 3.2.5.

The regularity in space (i.e. in the x -variable) is obtained from (3.4.2) and from Sobolev embeddings recalled in **Result 1**. The regularity in time (i.e. in the t -variable) is given by Remark 3.2.9. Thus, we get the existence of $\delta := 2\alpha - \frac{1}{2} > 0$ such that

$$(v, u) \in \mathcal{C}^{\delta, \frac{\delta}{2}}(\mathbb{R} \times \mathbb{R}_+ \times (0, T]) \times \mathcal{C}^{\delta, \frac{\delta}{2}}(\mathbb{R} \times (0, T]).$$

– Case $n = 1$: We have to prove that

1. for all $x \in \mathbb{R}$ and $y \in \mathbb{R}_+$, the functions $v(x, y, \cdot)$ and $u(x, \cdot)$ are in $\mathcal{C}^{\frac{1+\delta}{2}}([\varepsilon_2, T])$,
2. for all $t \in [\varepsilon_2, T]$, the couple $(\partial_x v(\cdot, \cdot, t), \partial_x u(\cdot, t))$ exists and is in $\mathcal{C}^\delta(\mathbb{R} \times \mathbb{R}_+) \times \mathcal{C}^\delta(\mathbb{R})$,

where , for $\delta = 2\alpha - \frac{1}{2} > 0$.

Let us prove these two points :

1. If $\frac{1+\delta}{2} \in (0, 1)$, i.e. $\alpha \in (\frac{1}{4}, \frac{3}{4})$, the first point is true using Remark 3.2.9. If $\frac{1+\delta}{2} \in [1, \frac{3}{2})$, i.e. $\alpha \in (\frac{3}{4}, 1)$, we need to prove that, for all $x \in \mathbb{R}$ and $y \in \mathbb{R}_+$, $\partial_t v(x, y, \cdot)$ and $\partial_t u(x, \cdot)$ are $\frac{\delta-1}{2}$ Hölder continuous on $([\varepsilon_2, T])$. In the sequel, we will need Hölder regularity for $\partial_t v(x, y, \cdot)$ and $\partial_t u(x, \cdot)$ for all $\alpha \in (0, 1)$, that is why we prove it in the case $\alpha \in (0, 1)$.

From (3.4.2), we only know that

$$(\partial_t v, \partial_t u) \in \mathcal{C}((0, T]), L^2(\mathbb{R} \times \mathbb{R}_+) \times L^2(\mathbb{R}).$$

From Theorem 3.2.8 and Remark 3.2.9, it is sufficient to prove that $(\partial_t v, \partial_t u)$ is solution to

$$\partial_t w + Aw = F_1(w, t), \quad t > \varepsilon_1, \quad (3.4.4)$$

starting from $(\partial_t v(\cdot, \cdot, \varepsilon_1), \partial_t u(\cdot, \varepsilon_1)) \in L^2(\mathbb{R} \times \mathbb{R}_+) \times L^2(\mathbb{R})$, where F_1 is defined on $X \times \mathbb{R}_+$ by

$$F_1 \left(\begin{pmatrix} w_1 \\ w_2 \end{pmatrix}, t \right) = \begin{pmatrix} w_1 f'(v(\cdot, \cdot, t)) \\ 0 \end{pmatrix}. \quad (3.4.5)$$

As is usual, we can not directly differentiate equation (3.4.1) with respect to time, that is why we consider, for $h > 0$, the functions v_h and u_h defined on $\mathbb{R} \times \mathbb{R}_+ \times \mathbb{R}_+$ by

$$v_h(\cdot, \cdot, t) := \frac{v(\cdot, \cdot, t+h) - v(\cdot, \cdot, t)}{h} \quad \text{and} \quad u_h(\cdot, t) := \frac{u(\cdot, t+h) - u(\cdot, t)}{h}.$$

For any $h > 0$, (v_h, u_h) is in $D(A)$ and satisfies

$$\partial_t \begin{pmatrix} v_h \\ u_h \end{pmatrix} + A \begin{pmatrix} v_h \\ u_h \end{pmatrix} = \begin{pmatrix} \frac{f(v(\cdot, \cdot, t+h)) - f(v(\cdot, \cdot, t))}{h} \\ 0 \end{pmatrix}, \quad t > 0. \quad (3.4.6)$$

The right hand side satisfies Hypothesis 3.2.5 and tends to $F_1 \left(\begin{pmatrix} \partial_t v \\ \partial_t u \end{pmatrix}, t \right)$ as h tends to 0. We know that, for all $(x, y) \in \mathbb{R} \times \mathbb{R}_+$, $v(x, y, \cdot)$ is Hölder continuous

in time, which implies that F_1 satisfies the assumptions of Theorem 3.2.8. Thus, from Theorem 3.2.10, we can pass to the limit as h tends to 0 in (3.4.6) to get that $(\partial_t v, \partial_t u)$ is the solution to (3.4.4), starting from $(\partial_t v(\cdot, \cdot, \varepsilon_1), \partial_t u(\cdot, \varepsilon_1)) \in L^2(\mathbb{R} \times \mathbb{R}_+) \times L^2(\mathbb{R})$. From Theorem 3.2.8 we conclude

$$(\partial_t v, \partial_t u) \in \mathcal{C}((\varepsilon_1, T], H^2(\mathbb{R} \times \mathbb{R}_+) \times H^{2\alpha}(\mathbb{R})) \cap \mathcal{C}^1((\varepsilon_1, T], L^2(\mathbb{R} \times \mathbb{R}_+) \times L^2(\mathbb{R})). \quad (3.4.7)$$

2. We now study, for all $t \in [\varepsilon_2, T]$, the couple $(\partial_x v(\cdot, \cdot, t), \partial_x u(\cdot, t))$. We first prove that, for all $t \in (0, T]$, $\partial_x u(\cdot, t)$ exists and

$$\partial_x u(\cdot, t) \in L^2(\mathbb{R}).$$

For $\alpha \in (\frac{1}{2}, 1)$, from (3.4.2), we clearly have this result.

For $\alpha \in (\frac{1}{4}, \frac{1}{2})$, from (3.4.2), we only have, for all $t \in (0, T]$, $(-\partial_{xx})^\alpha u(\cdot, t) \in L^2(\mathbb{R})$. To get more regularity on u , we use that

$$(-\partial_{xx})^{\frac{1}{2}} = (-\partial_{xx})^{\frac{1}{2}-\alpha} (-\partial_{xx})^\alpha.$$

Let us define $\gamma = \frac{1}{2} - \alpha \in (0, \alpha)$. From (3.4.2) and (3.4.7), we know that, for all $t \in [\varepsilon_2, T]$:

$$u(\cdot, t) \in H^{2\alpha}(\mathbb{R}), \quad \partial_t u(\cdot, t) \in H^{2\alpha}(\mathbb{R}) \quad \text{and} \quad v(\cdot, \cdot, t) \in H^2(\mathbb{R} \times \mathbb{R}_+).$$

Thus, we have for all $t \in [\varepsilon_2, T]$:

$$(-\partial_{xx})^\gamma u(\cdot, t) \in L^2(\mathbb{R}), \quad (-\partial_{xx})^\gamma \partial_t u(\cdot, t) \in L^2(\mathbb{R}) \quad \text{and} \quad v(\cdot, 0, t) \in H^{\frac{3}{2}}(\mathbb{R}).$$

Applying the operator $(-\partial_{xx})^\gamma$ to the equation

$$\partial_t u(x, t) + (-\partial_{xx})^\alpha u(x, t) = -(\mu + k)u(x, t) + v(x, 0, t),$$

we have for all $t \in [\varepsilon_2, T]$:

$$\begin{aligned} (-\partial_{xx})^{\frac{1}{2}} u(\cdot, t) &= (-\partial_{xx})^{\gamma+\alpha} u(\cdot, t) \\ &= -(\mu + k)(-\partial_{xx})^\gamma u(\cdot, t) + (-\partial_{xx})^\gamma v(\cdot, 0, t) - (-\partial_{xx})^\gamma \partial_t u(\cdot, t). \end{aligned}$$

This proves that for all $t \in [\varepsilon_2, T]$

$$\partial_x u(\cdot, t) \in L^2(\mathbb{R}).$$

It remains to prove that for all $t \in [\varepsilon_2, T]$,

$$(\partial_x v(\cdot, \cdot, t), \partial_x u(\cdot, t)) \in \mathcal{C}^\delta(\mathbb{R} \times \mathbb{R}_+) \times \mathcal{C}^\delta(\mathbb{R}).$$

As done in the case $n = 1$, from Theorem 3.2.8 and Remark 3.2.9, it is sufficient to prove that $(\partial_x v, \partial_x u)$ is solution to (3.4.4), starting from $(\partial_x v(\cdot, \cdot, \varepsilon_2), \partial_x u(\cdot, \varepsilon_2)) \in L^2(\mathbb{R} \times \mathbb{R}_+) \times L^2(\mathbb{R})$, where F_1 is defined in (3.4.5).

Once again, we can not directly differentiate equation (3.4.1) with respect to x , that is why we consider, for $h > 0$, the functions v_h and u_h defined on $\mathbb{R} \times \mathbb{R}_+ \times \mathbb{R}_+$ by :

$$v_h(x, \cdot, \cdot) := \frac{v(x+h, \cdot, \cdot) - v(x, \cdot, \cdot)}{h} \quad \text{and} \quad u_h(x, \cdot) := \frac{u(x+h, \cdot) - u(x, \cdot)}{h}.$$

Passing to the limit as h tends to 0 in the problem solved by (v_h, u_h) , Theorem 3.2.10 gives that $(\partial_x v, \partial_x u)$ is solution to (3.4.4) with $(\partial_x v(\cdot, \cdot, \varepsilon_2), \partial_x u(\cdot, \varepsilon_2))$ as initial datum. Theorem 3.2.8 gives also

$$(\partial_x v, \partial_x u) \in \mathcal{C}((\varepsilon_2, T], H^2(\mathbb{R} \times \mathbb{R}_+) \times H^{2\alpha}(\mathbb{R})) \cap \mathcal{C}^1((\varepsilon_2, T], L^2(\mathbb{R} \times \mathbb{R}_+) \times L^2(\mathbb{R})).$$

– Case $n = 2$: we have to prove that

1. for all $x \in \mathbb{R}$ and $y \in \mathbb{R}_+$, the functions $v(x, y, \cdot)$ and $u(x, \cdot)$ are in $\mathcal{C}^{1+\frac{\delta}{2}}([\varepsilon_2, T])$,
2. for all $t \in [\varepsilon_2, T]$, the couple $(\partial_{xx} v(\cdot, \cdot, t), \partial_{xx} u(\cdot, t))$ exists and is in $\mathcal{C}^\delta(\mathbb{R} \times \mathbb{R}_+) \times \mathcal{C}^\delta(\mathbb{R})$,

where $\delta = 2\alpha - \frac{1}{2} > 0$.

1. The first point, that concerns the regularity in time has been proved in the first point of case $n = 1$.

2. We prove the Hölder continuity in space of the second derivatives of v and u separately.

We first prove that the regularity of v is given by **Result 2**. Notice that $v(\cdot, \cdot, \varepsilon_3)$ satisfies

$$\partial_t v(\cdot, \cdot, \varepsilon_3) - \Delta v(\cdot, \cdot, \varepsilon_3) = f(v(\cdot, \cdot, \varepsilon_3)).$$

From (3.4.7), (3.4.2) and Result 1, $\partial_t v(\cdot, \cdot, \varepsilon_3)$ and $f(v(\cdot, \cdot, \varepsilon_3))$ are Hölder continuous, which proves that

$$v(\cdot, \cdot, \varepsilon_3) \in \mathcal{C}^{2+\delta}(\mathbb{R} \times \mathbb{R}_+).$$

We also know that $(v, u) \in D(A)$ and, from the first point of the case $n = 1$, $(\partial_t v, \partial_t u) \in D(A)$, which prove the compatibility condition in **Result 2**. Thus, we can apply this result with

$$u_1 = u \in \mathcal{C}^{1+\delta, \frac{1+\delta}{2}}(\mathbb{R} \times [\varepsilon_3, T]), \quad g = f(v) \in \mathcal{C}^{1+\delta, \frac{1+\delta}{2}}(\mathbb{R} \times \mathbb{R}_+ \times [\varepsilon_3, T]),$$

and initial condition $v(\cdot, \cdot, \varepsilon_3)$, to get that

$$v \in \mathcal{C}^{2+\delta, 1+\frac{\delta}{2}}(\mathbb{R} \times \mathbb{R}_+ \times [\varepsilon_3, T]).$$

The regularity of $\partial_{xx}u$ is obtained as in the case $n = 1$:

- For all $\alpha \in (\frac{1}{4}, 1)$, we can prove that

$$(\partial_{xx}v(\cdot, \cdot, \varepsilon_4), \partial_{xx}u(\cdot, \varepsilon_4)) \in L^2(\mathbb{R} \times \mathbb{R}_+) \times L^2(\mathbb{R}),$$

- We notice that, using a limit on a suitable differential quotient and Theorem 3.2.10, we can get that $(\partial_{xx}v, \partial_{xx}u)$ is the solution to

$$\partial_t w + Aw = \begin{pmatrix} w_1 f'(v) + (\partial_x v)^2 f''(v) \\ 0 \end{pmatrix}, \quad (3.4.8)$$

starting from $(\partial_{xx}v(\cdot, \cdot, \varepsilon_4), \partial_{xx}u(\cdot, \varepsilon_4))$. We know that f is $\mathcal{C}^\infty(\mathbb{R})$ and $\partial_x v(\cdot, t)$ is bounded in $L^2(\mathbb{R} \times \mathbb{R}_+)$ uniformly in time, as solution to (3.4.4) (see Theorem 3.2.8). From Theorem 3.2.8 and Remark 3.2.9 applied to (v, u) , we have that $v(\cdot, t)$ is bounded in X , uniformly in time and $v(x, \cdot)$ is Hölder continuous, uniformly in $L^2(\mathbb{R} \times \mathbb{R}_+)$. Consequently, the right hand side of (3.4.8) satisfies the assumptions of Theorem 3.2.8. Thus we have that $(\partial_{xx}v, \partial_{xx}u)$ belongs to

$$\mathcal{C}((\varepsilon_4, T], H^2(\mathbb{R} \times \mathbb{R}_+) \times H^{2\alpha}(\mathbb{R})) \cap \mathcal{C}^1((\varepsilon_4, T], L^2(\mathbb{R} \times \mathbb{R}_+) \times L^2(\mathbb{R})),$$

and a similar proof as the one done in the case $n = 0$ leads to

$$(\partial_{xx}v, \partial_{xx}u) \in \mathcal{C}^{\delta, \frac{\delta}{2}}(\mathbb{R} \times \mathbb{R}_+ \times (\varepsilon_4, T]) \times \mathcal{C}^{\delta, \frac{\delta}{2}}(\mathbb{R} \times (\varepsilon_4, T]),$$

which ends the case $n = 2$.

Iterating, we get (3.4.3) for all $n \in \mathbb{N}$ and all $\varepsilon > 0$.

Once we know that the solution (v, u) to (3.1.1) is regular in space and time, we can simplify the notations and the Cauchy problem under study becomes

$$\begin{cases} \partial_t v - \Delta v = f(v), & x \in \mathbb{R}, y > 0, t > 0, \\ \partial_t u + (-\partial_{xx})^\alpha u = -\mu u + v|_{y=0} - ku, & x \in \mathbb{R}, y = 0, t > 0, \\ -\partial_y v|_{y=0} = \mu u - v|_{y=0}, & x \in \mathbb{R}, y = 0, t > 0, \end{cases}$$

with initial conditions $v(\cdot, \cdot, 0) = v_0$ and $u(\cdot, 0) = u_0$.

Remark 3.4.1. In the particular case of x -independent solutions, Theorem 3.2.8 gives that the x -independent solution $(v_{\natural}, u_{\natural})$ to (3.1.1) with initial condition in $X_{\natural} = L^2(\mathbb{R}_+) \times \mathbb{R}$ satisfies

$$(v_{\natural}, u_{\natural}) \in \mathcal{C}((0, +\infty), H^2(\mathbb{R}_+) \times \mathbb{R}) \cap \mathcal{C}^1((0, +\infty), L^2(\mathbb{R}_+) \times \mathbb{R}).$$

By Sobolev embeddings, we have (see [2] for example)

$$H^2(\mathbb{R}_+) \subset \mathcal{C}^{\frac{1}{2}}(\mathbb{R}_+).$$

A similar proof as the one done to get the regularity of the solution to (3.1.1) starting from a datum in X , gives that x -independent solution $(v_{\natural}, u_{\natural})$ satisfies

$$v_{\natural} \in \mathcal{C}^{\infty}(\mathbb{R}_+ \times (0, +\infty)) \quad \text{and} \quad u_{\natural} \in \mathcal{C}^{\infty}((0, +\infty)).$$

3.4.2 Comparison principle

Before giving a comparison principle for classical solutions, we need the following intermediate lemma that we recall for the sake of completeness. It gives, by a simple computation, the positivity of an integral that will appear in the proof of the comparison principle.

Lemma 3.4.2. *Let $\alpha \in (0, 1)$. For any function h satisfying $(-\Delta)^{\alpha}h \in L^2(\mathbb{R})$, and $h^+ \in L^2(\mathbb{R})$, we have*

$$\int_{\mathbb{R}} (-\Delta)^{\alpha}h(x)h^+(x)dx \geq 0.$$

Proof : For any function h that satisfies the assumptions of the lemma, let us define the finite quantity $I = \int_{\mathbb{R}} (-\Delta)^{\alpha}h(x)h^+(x)dx$. We have

$$\begin{aligned} I &= \iint_{\mathbb{R}^2} \frac{h(x) - h(\bar{x})}{|x - \bar{x}|^{1+2\alpha}} h^+(x) d\bar{x} dx \\ &= \frac{1}{2} \iint_{\mathbb{R}^2} \frac{(h(x) - h(\bar{x}))(h^+(x) - h^+(\bar{x}))}{|x - \bar{x}|^{1+2\alpha}} d\bar{x} dx \\ &= \iint_{\mathbb{R}^2} \frac{(h^+(x) - h^+(\bar{x}))^2}{2|x - \bar{x}|^{1+2\alpha}} d\bar{x} dx - \iint_{\mathbb{R}^2} \frac{(h^-(x) - h^-(\bar{x}))(h^+(x) - h^+(\bar{x}))}{2|x - \bar{x}|^{1+2\alpha}} d\bar{x} dx. \end{aligned}$$

For all $(x, \bar{x}) \in \mathbb{R}^2$:

$$(h^-(x) - h^-(\bar{x}))(h^+(x) - h^+(\bar{x})) = \begin{cases} 0 & \text{if } h(x)h(\bar{x}) > 0, \\ -h^+(x)h^-(x) & \text{if } h(x) > 0 \text{ and } h(\bar{x}) < 0, \\ -h^-(x)h^+(x) & \text{if } h(x) < 0 \text{ and } h(\bar{x}) > 0. \end{cases}$$

This quantity is nonpositive, which concludes the proof. ■

The following theorem gives a comparison principle for classical solutions in $H^2(\mathbb{R} \times \mathbb{R}_+) \times H^{2\tilde{\alpha}}(\mathbb{R})$, for $\tilde{\alpha} = \max(\frac{1}{4}, 1)$, to the Cauchy problem (3.1.1).

Theorem 3.4.3. *Let $(v_1, u_1), (v_2, u_2)$ be two couples in $\mathcal{C}((0, +\infty), H^2(\mathbb{R} \times \mathbb{R}_+) \times H^{2\tilde{\alpha}}(\mathbb{R})) \cap \mathcal{C}^1((0, +\infty), L^2(\mathbb{R} \times \mathbb{R}_+) \times L^2(\mathbb{R}))$, for $\tilde{\alpha} = \max(\frac{1}{4}, 1)$, that satisfy, almost everywhere in the (x, y) -variable :*

$$\begin{cases} \partial_t v_1 - \Delta v_1 \leq f(v_1), & x \in \mathbb{R}, y > 0, t > 0, \\ \partial_t u_1 + (-\partial_{xx})^\alpha u_1 \leq -\mu u_1 + \gamma_0 v_1 - k u_1, & x \in \mathbb{R}, y = 0, t > 0, \\ \gamma_1 v_1 \leq \mu u_1 - \gamma_0 v_1, & x \in \mathbb{R}, y = 0, t > 0, \end{cases}$$

and

$$\begin{cases} \partial_t v_2 - \Delta v_2 \geq f(v_2), & x \in \mathbb{R}, y > 0, t > 0, \\ \partial_t u_2 + (-\partial_{xx})^\alpha u_2 \geq -\mu u_2 + \gamma_0 v_2 - k u_2, & x \in \mathbb{R}, y = 0, t > 0, \\ \gamma_1 v_2 \geq \mu u_2 - \gamma_0 v_2, & x \in \mathbb{R}, y = 0, t > 0. \end{cases}$$

If, for almost all $(x, y) \in \mathbb{R} \times \mathbb{R}_+$,

$$v_1(x, y, 0) \leq v_2(x, y, 0) \quad \text{and} \quad u_1(x, 0) \leq u_2(x, 0),$$

then for all $t \geq 0$ and for almost all $(x, y) \in \mathbb{R} \times \mathbb{R}_+$, we have

$$v_1(x, y, t) \leq v_2(x, y, t) \quad \text{and} \quad u_1(x, t) \leq u_2(x, t).$$

Proof : Let $l > 0$ be a constant greater than the Lipschitz constant of f . We define the couple (v_3, u_3) for almost every $(x, y) \in \mathbb{R} \times \mathbb{R}_+$ and for all $t \geq 0$ by

$$(v_3(x, y, t), u_3(x, t)) := (v_1(x, y, t), u_1(x, t))e^{-lt} - (v_2(x, y, t), u_2(x, t))e^{-lt}. \quad (3.4.9)$$

Since f is Lipschitz, this couple satisfies, almost everywhere in the (x, y) -variable :

$$\begin{cases} \partial_t v_3 - \Delta v_3 \leq e^{-lt} f(v_1) - e^{-lt} f(v_2) - l v_3, & x \in \mathbb{R}, y > 0, t > 0, \\ \partial_t u_3 + (-\partial_{xx})^\alpha u_3 \leq -\mu u_3 + \gamma_0 v_3 - k u_3 - l u_3, & x \in \mathbb{R}, y = 0, t > 0, \\ \gamma_1 v_3 \leq \mu u_3 - \gamma_0 v_3, & x \in \mathbb{R}, y = 0, t > 0, \end{cases} \quad (3.4.10)$$

with initial conditions

$$v_3(\cdot, \cdot, 0) = v_1(\cdot, \cdot, 0) - v_2(\cdot, \cdot, 0) \quad \text{and} \quad u_3(\cdot, 0) = u_1(\cdot, 0) - u_2(\cdot, 0).$$

Almost everywhere respectively in $\mathbb{R} \times \mathbb{R}_+$ and \mathbb{R} we have

$$v_3(\cdot, \cdot, 0) \leq 0 \quad \text{and} \quad u_3(\cdot, 0) \leq 0.$$

Let us define v_3^+ (respectively u_3^+) the positive part of v_3 (respectively u_3). We prove that these functions are equal to 0 almost everywhere respectively on $\mathbb{R} \times \mathbb{R}_+$ and on \mathbb{R} for all $t > 0$. We multiply the first equation of (3.4.10) by v_3^+ and integrate over $\mathbb{R} \times \mathbb{R}_+$ to get

$$\iint_{x \in \mathbb{R}, y > 0} \partial_t v_3 v_3^+ dx dy - \iint_{x \in \mathbb{R}, y > 0} \Delta v_3 v_3^+ dx dy \leq \iint_{x \in \mathbb{R}, y > 0} (l|v_3| - lv_3)v_3^+ dx dy = 0. \quad (3.4.11)$$

The first integral in (3.4.11) is treated as follows. Since v_1 and v_2 belong to $\mathcal{C}((0, +\infty), H^2(\mathbb{R} \times \mathbb{R}_+)) \cap \mathcal{C}^1((0, +\infty), L^2(\mathbb{R} \times \mathbb{R}_+))$, the function v_3^+ satisfies

$$v_3^+ \in \mathcal{C}([0, +\infty), H^2(\mathbb{R} \times \mathbb{R}_+)),$$

and its derivative satisfies, in the scalar distribution sense (see [42]),

$$\partial_t v_3^+ = \begin{cases} \partial_t v_3 & \text{a.e. on } \{v_3 > 0\}, \\ 0 & \text{a.e. on } \{v_3 \leq 0\}. \end{cases}$$

Thus we have for all $t > 0$, $v_3^+(\cdot, \cdot, t) \in H^1(\mathbb{R} \times \mathbb{R}_+)$. Consequently, differentiating the scalar product (in $L^2(\mathbb{R} \times \mathbb{R}_+)$) $\langle v_3^+(\cdot, \cdot, t), v_3^+(\cdot, \cdot, t) \rangle$ with respect to t , we obtain

$$\frac{d}{dt} \|v_3^+(\cdot, \cdot, t)\|_{L^2(\mathbb{R} \times \mathbb{R}_+)}^2 = 2 \langle \partial_t v_3^+(\cdot, \cdot, t), v_3^+(\cdot, \cdot, t) \rangle,$$

which can also be written for all $t > 0$

$$\iint_{x \in \mathbb{R}, y > 0} \partial_t v_3 v_3^+ dx dy = \frac{1}{2} \frac{d}{dt} \left(\iint_{x \in \mathbb{R}, y > 0} |v_3^+|^2 dx dy \right). \quad (3.4.12)$$

Then, the second integral in (3.4.11) is treated with Green's formula. Since the function v_3 is in $H^2(\mathbb{R} \times \mathbb{R}_+)$, we have

$$\iint_{x \in \mathbb{R}, y > 0} \Delta v_3 v_3^+ dx dy = - \iint_{x \in \mathbb{R}, y > 0} |\nabla v_3^+|^2 dx dy + \int_{x \in \mathbb{R}} \gamma_1 v_3 \gamma_0 v_3^+ dx.$$

Using the third equation of (3.4.10) and the fact that $\gamma_0 v_3^+ \geq 0$, we have

$$\iint_{x \in \mathbb{R}, y > 0} \Delta v_3 v_3^+ dx dy \leq - \iint_{x \in \mathbb{R}, y > 0} |\nabla v_3^+|^2 dx dy + \mu \int_{\mathbb{R}} u_3 \gamma_0 v_3^+ dx - \int_{\mathbb{R}} |\gamma_0 v_3^+|^2 dx.$$

Inserting this last inequality and (3.4.12) in (3.4.11), we get

$$\frac{1}{2} \frac{d}{dt} \left(\iint_{x \in \mathbb{R}, y > 0} |v_3^+|^2 dx dy \right) \leq - \iint_{x \in \mathbb{R}, y > 0} |\nabla v_3^+|^2 dx dy + \mu \int_{\mathbb{R}} u_3^+ \gamma_0 v_3^+ dx. \quad (3.4.13)$$

Then we multiply the second equation of (3.4.10) by u_3^+ and integrate over \mathbb{R} to get

$$\int_{\mathbb{R}} \partial_t u_3 u_3^+ dx + \int_{\mathbb{R}} (-\Delta)^\alpha u_3 u_3^+ dx = -(\mu + k) \int_{\mathbb{R}} |u_3^+|^2 dx + \int_{\mathbb{R}} u_3^+ \gamma_0 v_3 dx. \quad (3.4.14)$$

As obtained in (3.4.12), for all $t > 0$, $u_3^+(\cdot, t) \in H^1(\mathbb{R})$ and consequently we have

$$\int_{\mathbb{R}} \partial_t u_3 u_3^+ dx = \frac{1}{2} \frac{d}{dt} \left(\int_{\mathbb{R}} |u_3^+|^2 dx \right).$$

Lemma 3.4.2 proves that the term $\int_{x \in \mathbb{R}} (-\Delta)^\alpha u_3 u_3^+ dx$ is nonnegative and thus (3.4.14) becomes

$$\frac{1}{2} \frac{d}{dt} \left(\int_{\mathbb{R}} |u_3^+|^2 dx \right) \leq \int_{\mathbb{R}} u_3^+ \gamma_0 v_3^+ dx. \quad (3.4.15)$$

The continuity of the trace operator recalled in Theorem 3.2.1 gives a constant $C_{tr} > 0$ such that

$$\|\gamma_0 v_3^+\|_{L^2(\mathbb{R})}^2 \leq C_{tr}^2 \left(\|v_3^+\|_{L^2(\mathbb{R} \times \mathbb{R}_+)}^2 + \|\nabla v_3^+\|_{L^2(\mathbb{R} \times \mathbb{R}_+)}^2 \right).$$

From this inequality and summing (3.4.13) and (3.4.15), we have

$$\begin{aligned} \frac{1}{2} \frac{d}{dt} \left(\|u_3^+\|_{L^2(\mathbb{R})}^2 + \|v_3^+\|_{L^2(\mathbb{R} \times \mathbb{R}_+)}^2 \right) &\leq (\mu + 1) \int_{\mathbb{R}} u_3^+ \gamma_0 v_3^+ dx - \|\nabla v_3^+\|_{L^2(\mathbb{R} \times \mathbb{R}_+)}^2 \\ &\leq (\mu + 1) \left(C_{tr}^2 (\mu + 1) \|u_3^+\|_{L^2(\mathbb{R})}^2 + \frac{\|\gamma_0 v_3^+\|_{L^2(\mathbb{R})}^2}{C_{tr}^2 (\mu + 1)} \right) - \|\nabla v_3^+\|_{L^2(\mathbb{R} \times \mathbb{R}_+)}^2 \\ &\leq \max(1, C_{tr}^2 (\mu + 1)^2) \left(\|u_3^+\|_{L^2(\mathbb{R})}^2 + \|v_3^+\|_{L^2(\mathbb{R} \times \mathbb{R}_+)}^2 \right). \end{aligned}$$

Since $u_3^+(\cdot, 0) = 0$ and $v_3^+(\cdot, \cdot, 0) = 0$ almost everywhere, we have for all $t \geq 0$, $u_3^+(\cdot, t) = 0$ and $v_3^+(\cdot, \cdot, t) = 0$ almost everywhere, which concludes the proof. \blacksquare

This comparison principle is stated here for classical solutions whose initial condition belongs to X . However, it is necessary for later purposes to have a similar result for solutions starting from x -independent initial data.

As in section 3.3.4, we work in the Hilbert space $X_{\mathfrak{h}} = \{(v_{\mathfrak{h}}, u_{\mathfrak{h}}) \in L^2(\mathbb{R}_+) \times \mathbb{R}\}$. The following comparison principle deals with the comparison between a solution starting from an initial condition in X and a solution with an initial datum in $X_{\mathfrak{h}}$.

Theorem 3.4.4. *Let $(v_1, u_1) \in \mathcal{C}((0, +\infty), H^2(\mathbb{R} \times \mathbb{R}_+) \times H^{2\tilde{\alpha}}(\mathbb{R})) \cap \mathcal{C}^1((0, +\infty), L^2(\mathbb{R} \times \mathbb{R}_+) \times L^2(\mathbb{R}))$ and $(v_2, u_2) \in \mathcal{C}((0, +\infty), H^2(\mathbb{R}_+) \times \mathbb{R}) \cap \mathcal{C}^1((0, +\infty), L^2(\mathbb{R}_+) \times \mathbb{R})$ such that, almost everywhere in the (x, y) -variable :*

$$\begin{cases} \partial_t v_1 - \Delta v_1 \leq f(v_1), & x \in \mathbb{R}, y > 0, t > 0, \\ \partial_t u_1 + (-\partial_{xx})^\alpha u_1 \leq -\mu u_1 + \gamma_0 v_1 - k u_1, & x \in \mathbb{R}, y = 0, t > 0, \\ \gamma_1 v_1 \leq \mu u_1 - \gamma_0 v_1, & x \in \mathbb{R}, y = 0, t > 0, \end{cases}$$

and

$$\begin{cases} \partial_t v_2 - \partial_{yy} v_2 \geq f(v_2), & y > 0, t > 0, \\ u_2' \geq -\mu u_2 + \gamma_0 v_2 - k u_2, & t > 0, \\ \gamma_1 v_2 \geq \mu u_2 - \gamma_0 v_2, & t > 0. \end{cases} \quad (3.4.16)$$

If for almost all $y \geq 0$

$$v_2(y, 0) \geq 0 \quad \text{and} \quad u_2(0) \geq 0,$$

and for almost all $(x, y) \in \mathbb{R} \times \mathbb{R}_+$

$$v_1(x, y, 0) \leq v_2(y, 0) \quad \text{and} \quad u_1(x, 0) \leq u_2(0),$$

then for all $t \geq 0$ and for almost all $(x, y) \in \mathbb{R} \times \mathbb{R}_+$, we have

$$v_1(x, y, t) \leq v_2(y, t) \quad \text{and} \quad u_1(x, t) \leq u_2(t).$$

A similar result is true if (v_1, u_1) is a supersolution to (1.1.1) and (v_2, u_2) a subsolution to the x -independent problem (3.4.16) with nonpositive initial conditions.

Proof : This proof follows the one done to prove Theorem 3.4.3. We first notice that for almost every $y \geq 0$ and for all $t \geq 0$:

$$v_2(y, t) \geq 0 \quad \text{and} \quad u_2(t) \geq 0.$$

These inequalities are true for $t = 0$ by assumption, and obtained, similarly to the proof of Theorem 3.4.3, multiplying the first (respectively second) equation of (3.4.16) by v_2^- (respectively u_2^-), integrating over \mathbb{R} , and doing an integration by parts.

Let us define the couple (v_3, u_3) , for almost every $(x, y) \in \mathbb{R} \times \mathbb{R}_+$ and for all $t \geq 0$, by

$$(v_3(x, y, t), u_3(x, t)) = (v_1(x, y, t), u_1(x, t))e^{-lt} - (v_2(x, t), u_2(t))e^{-lt}, \quad (3.4.17)$$

where l is the Lipschitz constant of the source term f . Thus, using that, for all $t \geq 0$, $(v_1(\cdot, \cdot, t), u_1(\cdot, t)) \in H^2(\mathbb{R} \times \mathbb{R}_+) \times H^{2\tilde{\alpha}}(\mathbb{R})$ and $(v_2(\cdot, t), u_2(t)) \in H^2(\mathbb{R}_+) \times \mathbb{R}$, we conclude that the couple (v_3, u_3) has its positive part (v_3^+, u_3^+) in $H^1(\mathbb{R} \times \mathbb{R}_+) \times L^2(\mathbb{R})$. Consequently, the computations done in the proof of Theorem 3.4.3 are still valid and conclude the proof. ■

The following two remarks are consequences of these comparison principles and will be used in the sequel.

Remark 3.4.5. A similar result as Theorem 3.4.4 is still valid if we consider two x independent couples (v_1, u_1) and (v_2, u_2) both in

$$\mathcal{C}((0, +\infty), H^2(\mathbb{R}_+) \times \mathbb{R}) \cap \mathcal{C}^1((0, +\infty), L^2(\mathbb{R}_+) \times \mathbb{R}).$$

Remark 3.4.6. We can adapt the result of Theorem 3.4.4, to prove that the solution (v, u) to (4.1.1), starting from an initial condition $(v_0, u_0) \in X$ (or $X_{\frac{1}{\mu}}$) that satisfies for almost every $(x, y) \in \mathbb{R} \times \mathbb{R}_+$

$$0 \leq v_0(x, y) \leq 1 \quad \text{and} \quad 0 \leq u_0(x) \leq \frac{1}{\mu},$$

remains bounded at any time, with the same bounds as (v_0, u_0) . More precisely, by Theorem 3.4.4, the solution (v, u) is nonnegative. To prove that $(1, \frac{1}{\mu})$ is above (v, u) , we can not directly apply Theorem 3.4.4. However, the proof of Theorem 3.4.3 (respectively 3.4.4) only requires that (v_3, u_3) defined in (3.4.9) (respectively (3.4.17)) satisfies

- $\Delta v_3 \in L^2(\mathbb{R} \times \mathbb{R}^+)$, $v_3^+ \in H^1(\mathbb{R} \times \mathbb{R}^+)$,
- $(-\Delta)^\alpha u_3 \in L^2(\mathbb{R})$, and $u_3^+ \in L^2(\mathbb{R})$.

Thus, we have for all $t \geq 0$ and for almost every $(x, y) \in \mathbb{R} \times \mathbb{R}_+$

$$0 \leq v(x, y, t) \leq 1 \quad \text{and} \quad 0 \leq u(x, t) \leq \frac{1}{\mu}.$$

Remark 3.4.7. As said in the introduction, we want to understand what happens to the smooth solution (v, u) to (4.1.1) with a nonnegative and compactly supported initial condition (v_0, u_0) , when $\alpha \in (1/4, 1)$. Here we prove that it is sufficient to study the behaviour of the solution (v_1, u_1) starting from $(0, u_0)$ where u_0 is nonnegative and compactly supported.

First we notice that $v_1(\cdot, \cdot, 1)$ and $u_1(\cdot, 1)$ are positive. In fact, from remark 3.4.6, we already know that (v_1, u_1) is nonnegative at any time. We also know that v_1 satisfies

$$\begin{cases} \partial_t v_1 - \Delta v_1 = f(v_1), & x \in \mathbb{R}, y > 0, t > 0, \\ -\partial_y v_1|_{y=0} + v_1|_{y=0} \geq 0, & x \in \mathbb{R}, y = 0, t > 0. \end{cases}$$

The classical strong maximum principle gives $v_1(x, y, 1) > 0$ for all $(x, y) \in \mathbb{R} \times \mathbb{R}_+$. The same can be done for u_1 . Indeed, this function satisfies, for $\mu > 0$ and $k \geq 0$,

$$\partial_t u_1 + (-\partial_{xx})^\alpha u_1 + (\mu + k)u_1 \geq 0,$$

and the classical strong maximum principle gives $u_1(x, 1) > 0$, for all $x \in \mathbb{R}$.

Thus, if v_0 and u_0 are compactly supported, there exists a constant $a \geq 1$ such that for all $(x, y) \in \mathbb{R} \times \mathbb{R}_+$

$$v_0(x, y) \leq av_1(x, y, 1) \quad \text{and} \quad u_0(x) \leq u_1(x, 1).$$

Consequently, Theorem 3.4.3 added to the facts that $v_0 \geq 0$, f is concave and $(v(\cdot, \cdot, t), u(\cdot, t))$ and $(v_1(\cdot, \cdot, t), u_1(\cdot, t))$ are continuous in $\mathbb{R} \times \mathbb{R}_+$ and \mathbb{R} for $t > 0$, we have for all $(x, y, t) \in \mathbb{R} \times \mathbb{R}_+ \times \mathbb{R}_+$

$$v_1(x, y, t) \leq v(x, y, t) \leq av_1(x, y, t+1) \quad \text{and} \quad u_1(x, t) \leq u(x, t) \leq u_1(x, t+1).$$

In Chapter 4, we will study the long time behaviour of the solution starting from $(0, u_0)$, where u_0 is nonnegative and compactly supported.

Chapter 4

Long time behaviour

4.1 Introduction

In this chapter, we take $\alpha \in (\frac{1}{4}, 1)$ to work with smooth solutions to the Cauchy problem

$$\begin{cases} \partial_t v - \Delta v = f(v), & x \in \mathbb{R}, y > 0, t > 0, \\ \partial_t u + (-\partial_{xx})^\alpha u = -\mu u + v|_{y=0} - ku, & x \in \mathbb{R}, y = 0, t > 0, \\ -\partial_y v|_{y=0} = \mu u - v|_{y=0}, & x \in \mathbb{R}, y = 0, t > 0, \end{cases} \quad (4.1.1)$$

where $\mu > 0$, $k \geq 0$, completed with initial conditions $v(\cdot, \cdot, 0) = 0$ and $u(\cdot, 0) = u_0$. The choice of such an initial datum is justified by remark 3.4.7. The function u_0 is supposed to be nonnegative and compactly supported and the function f to be of Fisher-KPP type and of class $\mathcal{C}^\infty(\mathbb{R})$, which means

$$f \text{ is concave, } f(0) = f(1) = 0 \quad \text{and} \quad f > 0 \text{ in } (0, 1).$$

The main results obtained concern the speed of propagation on the line $\{(x, 0), x \in \mathbb{R}\}$, called "the road", and in the half plane $\mathbb{R} \times \mathbb{R}^+$, called "the field". Before giving them, we recall that the limiting state can be characterised just as in [17] and [18]. Indeed, we have the following theorem :

Theorem 4.1.1. *Problem (4.1.1) admits a unique positive bounded stationary solution (V_s, U_s) that is x -independent. The solution (v, u) to (4.1.1), starting from (v_0, u_0) a nonnegative, compactly supported and not identically equal to $(0, 0)$ initial condition, satisfies*

$$(v(x, y, t), u(x, t)) \xrightarrow[t \rightarrow +\infty]{} (V_s(y), U_s),$$

locally uniformly in $(x, y) \in \mathbb{R} \times \mathbb{R}_+$.

Since the convergence occurs in every compact sets of $\mathbb{R} \times \mathbb{R}_+$ for v (respectively \mathbb{R} for u), the result does not allow to follow the invasion front. The following two theorems give some information about the location of this front. They are in the same spirit as in [26], where the authors study the front position in Fisher-KPP equation with fractional diffusion. The first theorem focuses on the speed of propagation on the road and proves that it is exponential in time.

Theorem 4.1.2. *Let (v, u) be the solution to (4.1.1) with (v_0, u_0) as nonnegative, non identically equal to 0, compactly supported initial condition and $\alpha \in (\frac{1}{4}, 1)$. Set*

$$\gamma_* := \frac{f'(0)}{1 + 2\alpha}. \text{ Then we have}$$

$$1. \text{ if } \gamma < \gamma_*, \lim_{t \rightarrow +\infty} \inf_{|x| \leq e^{\gamma t}} u(x, t) > 0,$$

$$2. \text{ if } \gamma > \gamma_*, \lim_{t \rightarrow +\infty} \sup_{|x| \geq e^{\gamma t}} u(x, t) = 0.$$

The first point of Theorem 4.1.2 is proved following Steps 2 and 4 of the method described in the introduction of this thesis, even though some points diverge from it. Indeed, it seems difficult to construct a subsolution to the rescaled transport problem. To circumvent this difficulty, we work in a strip instead of the half plane and let the width go to infinity. This approach leads to a weak asymptotic expression of the speed of propagation in the sense of Theorem 4.1.2. The explicit subsolution constructed is of the form

$$\underline{v}(x, y, t) = \begin{cases} \phi(Bxe^{-\gamma t}) \sin\left(\frac{\pi}{L}y + h\right) & \text{if } 0 < y < L\left(1 - \frac{h}{\pi}\right), \\ 0 & \text{if } y \geq L\left(1 - \frac{h}{\pi}\right) \end{cases}, \quad \underline{u}(x, t) = c_h \phi(Bxe^{-\gamma t}),$$

where $\gamma \in \left(0, \frac{f'(0)}{1 + 2\alpha}\right)$, ϕ decays like $|\xi|^{-(1+2\alpha)}$ for large values of $|\xi|$, $L > 0$ is such that $L\left(1 - \frac{h}{\pi}\right)$ is the width of the strip, and B , h and c_h are well chosen positive constants.

The second point of Theorem 4.1.2 is proved computing the supersolution to (4.1.1) obtained by linearising problem (4.1.1) at 0. The Laplace transform recalled in Theorem 3.2.4 gives an explicit integral expression of this supersolution, which is turned into an explicit asymptotic expression for large values of $|x|$ and large values of t . The proof also reveals that the propagation can not be purely exponential but at most like $t^{-\frac{3}{2(1+2\alpha)}} e^{\frac{f'(0)}{(1+2\alpha)}t}$.

The second theorem deals with the propagation in the field. We prove that the speed of propagation, in any direction that makes an angle $\theta \in (0, \frac{\pi}{2}]$ with the road, is linear in time.

Theorem 4.1.3. *Let (v, u) be the solution to (4.1.1) with $(v_0, u_0) (\neq (0, 0))$ as nonnegative, compactly supported initial condition and $\alpha \in (\frac{1}{4}, 1)$. Set $c_{KPP} := 2\sqrt{f'(0)}$. Then for all $\theta \in (0, \pi)$, we have*

1. if $c > \frac{c_{KPP}}{\sin(\theta)}$, $\lim_{t \rightarrow +\infty} \sup_{r \geq ct} v(r \cos(\theta), r \sin(\theta), t) = 0$,
2. if $0 < c < \frac{c_{KPP}}{\sin(\theta)}$, $\lim_{t \rightarrow +\infty} \inf_{0 \leq r \leq ct} v(r \cos(\theta), r \sin(\theta), t) > 0$.

The speed of propagation is thus asymptotically equal to $\frac{c_{KPP}}{\sin(\theta)}$. When θ is close to 0, this speed is infinite, which is consistent with Theorem 4.1.2. The idea of the proof of Theorem 4.1.3 consists in considering that the infinite speed of propagation on the road imposes the density v to be close to 1 on almost all the real line, and, in any case, in much bigger sets than those of the form $\{(x, 0), |x| \leq ct\}$, with $c > 0$ constant. The invasion in the field is thus given by well known results on standard reaction-diffusion equation of Fisher-KPP type with $\mathbb{1}_{\{y=0\}}$ as initial condition (see for example [5]).

This chapter is split into three sections and organised as follows. The first two are devoted respectively to the construction of an explicit subsolution to (4.1.1) and to the estimate of a supersolution to (4.1.1) : this proves Theorem 4.1.2. The third section focuses on the proof of Theorem 4.1.3.

4.2 Construction of a subsolution

The construction of a subsolution $(\underline{v}, \underline{u})$ to (4.1.1) follows the method described in the introduction of this thesis. As explained in the introduction, we are not able to follow rigorously Step 2 of the method, i.e. to construct a subsolution to (4.1.1) in the half plane. To bypass this difficulty, we work in a strip whose width tends to infinity, which yields exponential speeds for all exponents less than, but not equal to, the optimal one.

This section is split into three subsections. First, we construct an auxiliary subsolution to a one-dimensional problem that will be needed to define $(\underline{v}, \underline{u})$. Second, we estimate the solution of (4.1.1) at time 2 in a strip of the form $\mathbb{R} \times [0, Y]$ for any constant $Y > 0$, which corresponds to Step 3 of the method. The last subsection is devoted to the proof of the first point of Theorem 4.1.2, and follows Step 4 of the method.

4.2.1 An auxiliary 1D subsolution

We will use the following lemma in the case $\sigma = 1 + 2\alpha$ to construct a subsolution to the nonlinear transport equations that appears when we follow Step 2 of the method.

Lemma 4.2.1. *Let σ be a positive constant and g a function of class $\mathcal{C}^\infty(\mathbb{R})$ satisfying $g(0) = 0$, $g'(0) > 0$. Then there exists a constant $\tilde{\gamma} = g'(0)\sigma^{-1}$ such that for all $\gamma \in [0, \tilde{\gamma}]$, the equation*

$$-\gamma x \psi'(x) = g(\psi(x)), \quad x \in \mathbb{R}, \quad (4.2.1)$$

admits a subsolution ϕ of class $\mathcal{C}^2(\mathbb{R})$, smaller than 1, with the prescribed decay $|x|^{-\sigma}$ for large values of $|x|$. More precisely, there exist constants $\beta > 0$, $A_1 > 0$, $A_2 > 0$, $\varepsilon > 0$ and a constant $D > 0$ depending on A_2 , σ and ε such that

– for all $|x| \geq A_2$,

$$-\gamma x\phi'(x) - g(\phi(x)) \leq -\frac{\beta}{|x|^{\sigma+\varepsilon}}, \quad -\phi''(x) \leq \frac{D}{|x|^{\sigma+\varepsilon}}, \quad (-\partial_{xx})^\alpha \phi(x) \leq \frac{D}{|x|^{\sigma+\varepsilon}}. \quad (4.2.2)$$

– for all $|x| \in (A_1, A_2)$, the function $x \mapsto -x\phi'(x)$ is smaller than $\sigma A_2^{-\sigma}$, and nondecreasing in $|x|$. Thus we have

$$-\gamma x\phi'(x) - g(\phi(x)) \leq -\beta v_{\sigma+\varepsilon}(A_2). \quad (4.2.3)$$

– for all $|x| \leq A_1$, $\phi(x) = \phi(A_1)$.

Proof : Let $\delta \in (0, 1)$ and $c_g > 0$ be such that g is nonnegative and increasing on $(0, \delta)$, and

$$\text{for all } s \in (0, \delta) : \quad g(s) \geq g'(0)s - c_g s^2. \quad (4.2.4)$$

For $\lambda \in \mathbb{R}_+$ and $x \neq 0$, we define

$$v_\lambda(x) := |x|^{-\lambda}.$$

Let us define several constants :

$$\tilde{\gamma} = g'(0)\sigma^{-1}, \quad \gamma \in (0, \tilde{\gamma}), \quad \varepsilon \in (0, \sigma), \quad (4.2.5)$$

$$A > \max\left((\gamma\varepsilon)^{-\frac{\varepsilon}{\sigma}}, \delta^{-\varepsilon/\sigma}, \sigma^{-\frac{1}{\sigma}}, 1\right) \quad \text{and} \quad A_1 = A^{1/\varepsilon} \left(1 + \frac{\varepsilon}{\sigma}\right)^{1/\varepsilon}. \quad (4.2.6)$$

Then, a first attempt to construct a subsolution satisfying the conditions imposed by the lemma, could be

$$\phi_1(x) := \begin{cases} v_\sigma(x) - Av_{\sigma+\varepsilon}(x) & \text{if } |x| \geq A_1, \\ \frac{1}{A_1^\sigma} - \frac{A}{A_1^{\sigma+\varepsilon}} & \text{if } |x| \leq A_1. \end{cases}$$

This function of class $\mathcal{C}^1(\mathbb{R})$ is positive and nonincreasing in $|x|$. If $\alpha \geq 1/2$, the function ϕ_1 is not regular enough to get an estimate of its fractional laplacian. Consequently, we modify it so that it is of class $\mathcal{C}^2(\mathbb{R})$. This argument is, by the way, not so far from that of Silvestre in [80] in the study of the regularity of solutions of integral equations. We define

$$A_3 = A^{1/\varepsilon} \left(1 + \frac{\varepsilon}{\sigma}\right)^{1/\varepsilon} \left(1 + \frac{\varepsilon}{\sigma+1}\right)^{1/\varepsilon} > A_1,$$

and notice that ϕ_1 is concave for $A_1 \leq |x| \leq A_3$, and convex for $|x| \geq A_3$.

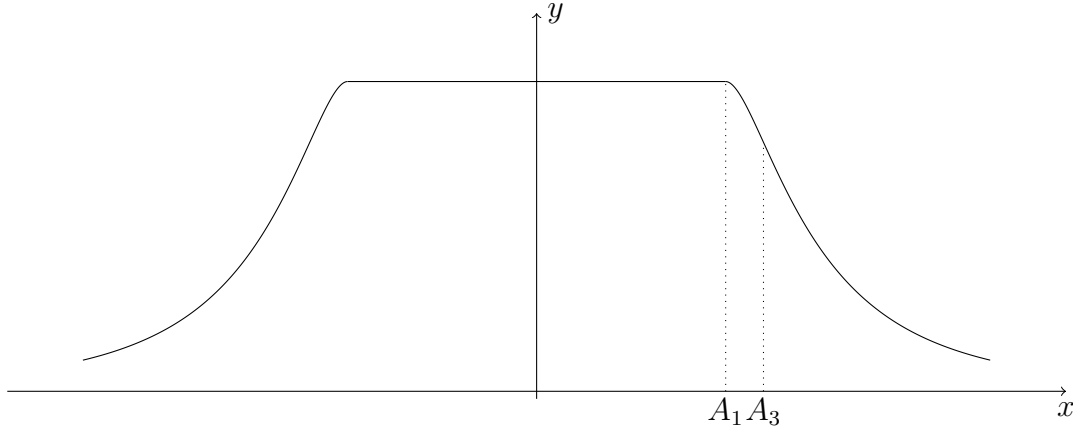
Graph of ϕ_1

We fix a constant $A_2 \in (A_1, A_3)$ and consider

$$\phi(x) := \begin{cases} v_\sigma(x) - Av_{\sigma+\varepsilon}(x) & \text{if } |x| \geq A_2, \\ \chi(|x|) & \text{if } A_1 < |x| < A_2, \\ \frac{1}{A_1^\sigma} - \frac{A}{A_1^{\sigma+\varepsilon}} = \phi_1(A_1) > 0 & \text{if } |x| \leq A_1, \end{cases}$$

where χ is a nonnegative and nonincreasing in $|x|$ function of class $\mathcal{C}^2(\mathbb{R})$, concave on (A_1, A_2) and chosen so that the function ϕ is $\mathcal{C}^2(\mathbb{R})$.

We also have for all $x \in \mathbb{R}$

$$0 \leq \phi(x) \leq \frac{1}{A_1^\sigma} - \frac{A}{A_1^{\sigma+\varepsilon}} \leq A_1^{-\sigma} \leq A^{-\sigma/\varepsilon} \leq \delta. \quad (4.2.7)$$

We first prove that ϕ is a subsolution to (4.2.1), treating separately the cases $|x| \geq A_2$, $|x| \in (A_1, A_2)$ and $|x| \leq A_1$.

- If $|x| \geq A_2 \geq A^{1/\varepsilon}$, with the choice of A done in (4.2.6), we have $\gamma\varepsilon - c_g A^{-\sigma/\varepsilon} > 0$. We define a positive constant β in $(0, A\gamma\varepsilon - c_g A^{-\frac{\sigma-\varepsilon}{\varepsilon}})$. Using inequality (4.2.7) and the assumption done on g in (4.2.4), we have $|x|^{\sigma-\varepsilon} \geq A^{\frac{\sigma-\varepsilon}{\varepsilon}} \geq c_g(A\gamma\varepsilon - \beta)^{-1} > 0$. This implies

$$\begin{aligned} -\gamma x \phi'(x) - g(\phi(x)) &\leq g'(0)\phi(x) - A\gamma\varepsilon v_{\sigma+\varepsilon}(x) - g(\phi(x)) \\ &\leq c_g \phi(x)^2 - A\gamma\varepsilon v_{\sigma+\varepsilon}(x) \\ &\leq c_g v_\sigma(x)^2 - A\gamma\varepsilon v_{\sigma+\varepsilon}(x) \\ &\leq -\beta v_{\sigma+\varepsilon}(x). \end{aligned} \quad (4.2.8)$$

The right hand side is smaller than 0 and this inequality proves the first estimate in (4.2.2).

– If $|x| \in (A_1, A_2)$, from the definition of χ , we have

$$-x\phi'(x) \leq \sigma A_2^{-\sigma}.$$

Then, due to the assumptions done on g in (4.2.4), the decay and the concavity of χ , the function $x \mapsto -\gamma x \chi'(|x|) - g(\chi(|x|))$ is continuous and nondecreasing in $|x|$, for $|x| \in (A_1, A_2)$. Consequently

$$\begin{aligned} -\gamma x \phi'(x) - g(\phi(x)) &= -\gamma x \chi'(|x|) - g(\chi(|x|)) \\ &\leq -\gamma A_2 \chi'(A_2) - g(\chi(A_2)) \leq -\beta v_{\sigma+\varepsilon}(A_2), \end{aligned}$$

as proved in (4.2.8). This inequality proves (4.2.3).

– If $|x| \leq A_1$, we have

$$-\gamma x \phi'(x) - g(\phi(x)) = -g(\phi(A_1)) \leq 0.$$

Then, we prove the estimates (4.2.2) for $|x| \geq A_2$. The first one has been proved in (4.2.8). The second estimate concerns ϕ'' . We define $D_1 = (\sigma + \varepsilon)(\sigma + \varepsilon - 1)A$ and we have for all $|x| > A^{1/\varepsilon} > 1$

$$-\phi''(x) \leq (\sigma + \varepsilon)(\sigma + \varepsilon + 1)Ax^{-2}v_{\sigma+\varepsilon}(x) \leq D_1 v_{\sigma+\varepsilon}(x).$$

The last estimate in (4.2.2) concerns $(-\partial_{xx})^\alpha \phi$. The function ϕ is of class $\mathcal{C}^2(\mathbb{R})$, radially symmetric and nonincreasing in $|x|$. It fulfills the assumptions of Lemma 1.3.1, which proves the existence of a constant $D_2 > 0$ such that for all $x \in \mathbb{R}$

$$(-\partial_{xx})^\alpha \phi(x) \leq D_2 \phi(x).$$

Take $D = \max(D_1, D_2)$ and the estimates in (4.2.2) are proved. ■

4.2.2 Bounding from below the solution at time 2

The following lemma corresponds to Step 2 of the method presented in the introduction of this thesis.

Lemma 4.2.2. *Let (p^v, p^u) be the solution to*

$$\left\{ \begin{array}{ll} \partial_t p^v - \Delta p^v = 0, & x \in \mathbb{R}, y > 0, t > 0, \\ \partial_t p^u + (-\partial_{xx})^\alpha p^u = -(\mu + k)p^u + p_{|y=0}^v, & x \in \mathbb{R}, y = 0, t > 0, \\ -\partial_y p_{|y=0}^v = \mu p^u - p_{|y=0}^v, & x \in \mathbb{R}, y = 0, t > 0, \end{array} \right. \quad (4.2.9)$$

with $\mu > 0$ and $k \geq 0$, completed with the initial data $p^v(\cdot, \cdot, 0) = 0$ and $p^u(\cdot, 0) = u_0$, where u_0 is a nonnegative and non identically equal to 0 function. Then, for any constant $Y > 0$, there exists a constant $a > 0$ such that for all $(x, y) \in \mathbb{R} \times [0, Y]$

$$p^v(x, y, 2) \geq \frac{a}{1 + |x|^{1+2\alpha}} \quad \text{and} \quad p^u(x, 2) \geq \frac{a}{1 + |x|^{1+2\alpha}}. \quad (4.2.10)$$

Proof : For all $t > 0$, the lower bound for p^u in (4.2.10) is easy to get. Indeed, Remark 3.4.6 ensures that, for all time $t > 0$, the function p^v is nonnegative on $\mathbb{R} \times \mathbb{R}_+$. Thus the second equation of (4.2.9) gives for all $x \in \mathbb{R}$ and all time $t > 0$

$$\partial_t p^u(x, t) + (-\partial_{xx})^\alpha p^u(x, t) \geq -(\mu + k)p^u(x, t).$$

Let us denote by p_α the fundamental solution to the fractional Laplacian in dimension one, that is to say the solution to

$$\begin{cases} \partial_t p_\alpha(x, t) + (-\partial_{xx})^\alpha p_\alpha(x, t) = 0, & x \in \mathbb{R}, t > 0, \\ p_\alpha(x, 0) = \delta_0(x), & x \in \mathbb{R}. \end{cases}$$

It is well known that the decay of p_α is like $|x|^{-(1+2\alpha)}$ for large values of $|x|$. The lower bound of p_α , in $\mathbb{R} \times [0, +\infty)$,

$$p_\alpha(x, t) \geq \frac{B^{-1}t}{t^{\frac{d}{2\alpha}+1} + |x|^{d+2\alpha}},$$

leads to the existence of a constant $a_1 > 0$, depending on u_0 and α , such that for all $x \in \mathbb{R}$ and all $t > 1$

$$p^u(x, t) \geq e^{-(\mu+k)t} u_0 \star p_\alpha(x, t) \geq a_1 \frac{t^{-1/2\alpha} e^{-(\mu+k)t}}{1 + |x|^{1+2\alpha}}. \quad (4.2.11)$$

We claim the existence of a constant $a > 0$ such that for all $x_0 \in \mathbb{R}$ and all $y \in [0, Y]$

$$p^v(x_0, y, 2) \geq \frac{a}{1 + |x_0|^{1+2\alpha}}.$$

Let us define $\underline{x}_0 > 0$ such that

$$\text{for all } x_0 \text{ satisfying } |x_0| \geq \underline{x}_0 : \quad \frac{1 + |x_0|^{1+2\alpha}}{1 + (1 + |x_0|)^{1+2\alpha}} \geq \frac{1}{2}. \quad (4.2.12)$$

Fix $x_0 \in \mathbb{R}$, and define

$$w(x, y, t) = (1 + |x_0|^{1+2\alpha}) p^v(x, y, t) \quad \text{on } \mathbb{R} \times \mathbb{R}_+ \times \mathbb{R}_+. \quad (4.2.13)$$

We have to prove that for all $y \in [0, Y]$

$$w(x_0, y, 2) \geq a.$$

The boundary condition satisfied by p^v in (4.2.9) and the estimate of p^u in (4.2.11) give, for all $x \in \mathbb{R}$ and $t > 1$

$$\begin{aligned} -\partial_y w(x, 0, t) + w(x, 0, t) &= \mu(1 + |x_0|^{1+2\alpha})p^u(x, t) \\ &\geq a_1 t^{-1/2\alpha} e^{-(\mu+k)t} \frac{1 + |x_0|^{1+2\alpha}}{1 + |x|^{1+2\alpha}}. \end{aligned}$$

Using the definition of \underline{x}_0 in (4.2.12), we have for $x_0 \in \mathbb{R}$ such that $|x_0| \geq \underline{x}_0$, for all $|x| \in (|x_0| - 1, |x_0| + 1)$ and $t \in (1, 3)$:

$$\begin{aligned} -\partial_y w(x, 0, t) + w(x, 0, t) &\geq a_1 t^{-1/2\alpha} e^{-(\mu+k)t} \frac{1 + |x_0|^{1+2\alpha}}{1 + (|x_0| + 1)^{1+2\alpha}} \\ &\geq \frac{a_1}{2} t^{-1/2\alpha} e^{-(\mu+k)t} \\ &\geq a_2, \end{aligned} \tag{4.2.14}$$

where $a_2 > 0$ is a constant.

Let χ be defined as follows

$$\chi(x) = \begin{cases} 1 & \text{if } |x| \leq \frac{1}{2}, \\ e^{-\frac{(|x|-1/2)^2}{(|x|-1)^2}} & \text{if } \frac{1}{2} \leq |x| \leq 1, \\ 0 & \text{if } |x| \geq 1. \end{cases}$$

For any $|x_0| \geq \underline{x}_0$, by the comparison principle, we have

$$w(x, y, t) \geq \underline{w}(x - x_0, y, t) \quad \text{for all } (x, y, t) \in \mathbb{R} \times \mathbb{R}_+ \times (1, 3), \tag{4.2.15}$$

where \underline{w} , is the solution to

$$\begin{cases} \partial_t \underline{w} - \Delta \underline{w} = 0, & x \in \mathbb{R}, y > 0, t > 1, \\ -\partial_y \underline{w}(x, 0, t) + \underline{w}(x, 0, t) = a_2 \chi(x), & x \in \mathbb{R}, t > 1, \\ \underline{w}_{x_0}(x, y, 1) = 0, & x \in \mathbb{R}, y \geq 0. \end{cases} \tag{4.2.16}$$

The existence and uniqueness of \underline{w} is given by Theorem 5.3 of [63]. Its regularity is inherited from the regularity of γ , that is for all $l > 0$

$$\underline{w} \in \mathcal{C}^{l+2, \frac{l}{2}+1}(\mathbb{R} \times \mathbb{R}_+ \times [1, 3]).$$

Finally, the existence of a constant $a_3 > 0$, such that for all $|x| \in (-1, 1)$, $y \in [0, Y]$ and $t \in (1, 3)$, we have

$$\underline{w}(x, y, t) \geq a_3,$$

is given by the regularity of \underline{w} , and the strong maximum principle applied to (4.2.16). Using (4.2.13) and (4.2.15), we conclude that for all $x_0 \in \mathbb{R}$ and all $y \in [0, Y]$

$$w(x_0, y, 2) = (1 + |x_0|^{1+2\alpha})p^v(x_0, y, 2) \geq \underline{w}(0, y, 2) \geq a_3. \quad (4.2.17)$$

Using (4.2.11) and (4.2.14), we have

$$p^u(x_0, 2) \geq \frac{a_2}{1 + |x_0|^{1+2\alpha}}. \quad (4.2.18)$$

Set $a = \min(a_2, a_3)$ so that, with (4.2.17) and (4.2.18), the lemma is proved. \blacksquare

4.2.3 Proof of Theorem 4.1.2 - Part 1

We want to prove that

$$\text{for all } 0 < \gamma < \frac{f'(0)}{1 + 2\alpha}, \quad \lim_{t \rightarrow +\infty} \inf_{|x| \leq e^{\gamma t}} u(x, t) > 0. \quad (4.2.19)$$

In what follows, we explicit Step 2 of the method, given in the introduction of the thesis. On the road, the fractional diffusion makes us think the speed of propagation to be exponential in time. Thus, we set $r(t) = e^{\gamma t}$ in Step 2 of the method, where γ is a constant in $\left(0, \frac{f'(0)}{1 + 2\alpha}\right)$. The analysis has the same flavour as that of Part I, but is technically more involved. We break it into several steps.

Step 1: Formal analysis

In this step, we rescale the x variable, defining the functions $\tilde{v}(\xi, y, t) = v(e^{\gamma t}\xi, y, t)$ and $\tilde{u}(\xi, t) = u(e^{\gamma t}\xi, t)$ for $\xi \in \mathbb{R}$, $y > 0$ and $t > 0$. We formally neglect the diffusive terms to get the following transport system

$$\begin{cases} \partial_t \tilde{v} - \gamma \xi \partial_\xi \tilde{v} - \partial_{yy} \tilde{v} = f(\tilde{v}), & \xi \in \mathbb{R}, y > 0, t > 0, \\ \partial_t \tilde{u} - \gamma \xi \partial_\xi \tilde{u} = -\mu \tilde{u} + \tilde{v} - k \tilde{u}, & \xi \in \mathbb{R}, y = 0, t > 0, \\ -\partial_y \tilde{v} = \mu \tilde{u} - \tilde{v}, & \xi \in \mathbb{R}, y = 0, t > 0. \end{cases} \quad (4.2.20)$$

By Step 4 of the method given in the introduction, we know that if $(\underline{V}(\xi, y), \underline{U}(\xi))$ is a stationary subsolution to (4.2.20), we can construct a subsolution $(\underline{v}, \underline{u})$ to the initial problem (4.1.1) by

$$\underline{v}(x, y, t) = \underline{V}(xb(t), y) \quad \text{and} \quad \underline{u}(x, t) = \underline{U}(xb(t)),$$

where b is a function asymptotically proportional to r^{-1} . Thus, we look for a subsolution to

$$\begin{cases} -\gamma\xi\partial_\xi V - \partial_{yy}V = f(V), & \xi \in \mathbb{R}, y > 0, \\ -\gamma\xi\partial_\xi U = -\mu U + V - kU, & \xi \in \mathbb{R}, y = 0, \\ -\partial_y V = \mu U - V, & \xi \in \mathbb{R}, y = 0. \end{cases} \quad (4.2.21)$$

Step 2: Construction of an explicit subsolution to the stationary system (4.2.21)

From now on, we diverge from the method set up in the introduction of this thesis. We construct a subsolution $(\underline{V}(\xi, y), \underline{U}(\xi))$ to (4.2.21), not in all $\mathbb{R} \times \mathbb{R}_+$, but in the strip $\mathbb{R} \times (0, L)$, for a constant L satisfying

$$L > \max \left(2, \pi \left(\frac{f'(0)}{1+2\alpha} - \gamma \right)^{-1/2} \right). \quad (4.2.22)$$

We want the subsolution to have the algebraic decay $|\xi|^{-(1+2\alpha)}$ for large value of $|\xi|$. Since $L > \pi f'(0)^{-1/2}$, we apply Lemma 4.2.1 with

$$g(s) = f(s) - \left(\frac{\pi}{L} \right)^2 s \quad \text{and} \quad \sigma = 1 + 2\alpha. \quad (4.2.23)$$

Let us define

$$\underline{V}(\xi, y) = \begin{cases} \phi(\xi) \sin \left(\frac{\pi}{L} y + h \right) & \text{if } 0 \leq y < L \left(1 - \frac{h}{\pi} \right) \\ 0 & \text{if } y \geq L \left(1 - \frac{h}{\pi} \right) \end{cases}, \quad \underline{U}(\xi) = c_h \phi(\xi), \quad (4.2.24)$$

where

$$h \in \left(0, \arctan \left(\frac{\pi}{L} \right) \right) \quad \text{and} \quad c_h = \min \left(\frac{\sin(h)}{2(\tilde{\gamma}\sigma + \mu + k)}, \frac{\sin(h)\phi(A_2)A_2^\sigma}{4\gamma\sigma} \right), \quad (4.2.25)$$

and $\phi, A_1, A_2, \tilde{\gamma}$ are given by Lemma 4.2.1. Note that with these choices,

$$\tilde{\gamma} = g'(0)\sigma^{-1} = \frac{f'(0) - (\pi/L)^2}{1 + 2\alpha}.$$

Let us prove that $(\underline{V}(\xi, y), \underline{U}(\xi))$ is a subsolution to (4.2.21). We treat separately the three equations in (4.2.21).

- It is a subsolution to the first equation of (4.2.21) : since $s \mapsto \frac{g(s)}{s}$ is decreasing, we have

– for $0 < y < L(1 - \frac{h}{\pi})$ and $\xi \in \mathbb{R}$

$$\begin{aligned} & -\gamma\xi\partial_\xi\underline{V}(\xi, y) - \partial_{yy}\underline{V}(\xi, y) - f(\underline{V}(\xi, y)) \\ & = \left(-\gamma\xi\phi'(\xi) + \left(\frac{\pi}{L}\right)^2 \phi(\xi) \right) \sin\left(\frac{\pi}{L}y + h\right) - f(\underline{V}(\xi, y)) \\ & = -\gamma\xi\phi'(\xi) \sin\left(\frac{\pi}{L}y + h\right) - g\left(\phi(\xi) \sin\left(\frac{\pi}{L}y + h\right)\right) \\ & \leq (-\gamma\xi\phi'(\xi) - g(\phi(\xi))) \sin\left(\frac{\pi}{L}y + h\right). \end{aligned}$$

The function ϕ was constructed in Lemma 4.2.1 so that the right hand side of the last inequality is smaller than or equal to 0.

– for $y \geq L(1 - \frac{h}{\pi})$ and $\xi \in \mathbb{R}$

$$-\gamma\xi\partial_\xi\underline{V}(\xi, y) - \partial_{yy}\underline{V}(\xi, y) - f(\underline{V}(\xi, y)) = 0.$$

– It is a subsolution to the second equation of (4.2.21). Indeed for $\xi \in \mathbb{R}$, since $\tilde{\gamma} = g'(0)\sigma^{-1}$, we have

$$-\gamma\xi\phi'(\xi) \leq g(\phi(\xi)) \leq g'(0)\phi(\xi) = \tilde{\gamma}\sigma\phi(\xi).$$

Thus we get for all $\xi \in \mathbb{R}$

$$\begin{aligned} -\gamma\xi\underline{U}'(\xi) + (\mu + k)\underline{U}(\xi) - \underline{V}(\xi, 0) & = -c_h\gamma\xi\phi'(\xi) + c_h(\mu + k)\phi(\xi) - \phi(\xi) \sin(h) \\ & \leq (c_h(\tilde{\gamma}\sigma + \mu + k) - \sin(h))\phi(\xi). \\ & \leq 0, \end{aligned}$$

with the choice done for c_h in (4.2.25).

– It is a subsolution to the third equation of (4.2.21). Indeed for $\xi \in \mathbb{R}$

$$-\partial_y\underline{V}(\xi, 0) - \mu\underline{U}(\xi) + \underline{V}(\xi, 0) = \left(-\frac{\pi}{L} \cos(h) - c_h\mu + \sin(h)\right) \phi(\xi) \leq 0,$$

thanks to (4.2.25).

Step 3: Subsolution to the initial problem (4.1.1)

The subsolution $(\underline{v}, \underline{u})$ that we are going to construct comes from $(\underline{V}, \underline{U})$ and is given by

$$\underline{v}(x, y, t) = \underline{V}(xb(t), y) \quad \text{and} \quad \underline{u}(x, t) = \underline{U}(xb(t)), \quad (4.2.26)$$

where $b(t) = Be^{-\gamma t}$ for a constant $B > 0$ small enough. More precisely, we have the following lemma.

Lemma 4.2.3. *Let $\gamma \in \left(0, \frac{f'(0)}{1+2\alpha}\right)$, β , D and ϕ be defined in Lemma 4.2.1 with the choice of g and σ done in (4.2.23). For any constant L satisfying (4.2.22) and $B > 0$, let us set*

$$\underline{v}(x, y, t) = \begin{cases} \phi(xb(t)) \sin\left(\frac{\pi}{L}y + h\right) & \text{if } 0 \leq y < L\left(1 - \frac{h}{\pi}\right) \\ 0 & \text{if } y \geq L\left(1 - \frac{h}{\pi}\right) \end{cases}, \quad \underline{u}(x, t) = c_h \phi(xb(t)),$$

where $b(t) = Be^{-\gamma t}$, h and c_h are defined in (4.2.25). Then there exists a constant $B > 0$ such that the couple $(\underline{v}, \underline{u})$ is a subsolution to the initial problem (4.1.1).

The constant $B > 0$ satisfies

$$B < \min \left(\sqrt{\frac{\beta}{D}}, \frac{\tilde{\gamma}\sigma + \mu + k}{D}, \sqrt{\frac{\beta v_{\sigma+\varepsilon}(A_2)}{\|\chi''\|_\infty}}, \left(\frac{\sin(h)\phi(A_2)}{2c_h \|(-\partial_{xx})^\alpha \phi\|_\infty} \right)^{\frac{1}{2\alpha}}, \left(\frac{\sin(h)}{2c_h D} \right)^{\frac{1}{2\alpha}} \right). \quad (4.2.27)$$

Proof : Let us define two operators \mathcal{L}_1 and \mathcal{L}_2 by

$$\mathcal{L}_1(v) = \partial_t v - \Delta v - f(v) \quad \text{and} \quad \mathcal{L}_2(v, u) = \partial_t u + (-\partial_{xx})^\alpha u + (\mu + k)u - \gamma_0 v.$$

Using the estimates (4.2.2) obtained in Lemma 4.2.1, we prove that $(\underline{v}, \underline{u})$ is a subsolution to (4.1.1), treating separately the three equations of (4.1.1).

– In the field :

– if $0 < y < L\left(1 - \frac{h}{\pi}\right)$ and $|x| > A_2 b(t)^{-1}$:

$$\begin{aligned} \mathcal{L}_1(\underline{v})(x, y, t) &= [b'(t)x\phi'(xb(t)) - b(t)^2\phi''(xb(t))] \sin\left(\frac{\pi}{L}y + h\right) \\ &\quad + \left(\frac{\pi}{L}\right)^2 \phi(xb(t)) \sin\left(\frac{\pi}{L}y + h\right) - f\left(\phi(xb(t)) \sin\left(\frac{\pi}{L}y + h\right)\right) \\ &\leq [-\gamma b(t)x\phi'(xb(t)) - g(\phi(xb(t)))] \sin\left(\frac{\pi}{L}y + h\right) \\ &\quad + Db(t)^2 v_{\sigma+\varepsilon}(xb(t)) \sin\left(\frac{\pi}{L}y + h\right) \\ &\leq (-\beta + DB^2)v_{\sigma+\varepsilon}(xb(t)) \sin\left(\frac{\pi}{L}y + h\right) \leq 0, \end{aligned}$$

from the choice done for B in (4.2.27).

– if $0 < y < L\left(1 - \frac{h}{\pi}\right)$ and $|x| \in (A_1 b(t)^{-1}, \tilde{A}_2 b(t)^{-1})$, using (4.2.3), we have

$$\begin{aligned} \mathcal{L}_1(\underline{v})(x, y, t) &= [b'(t)x\chi'(xb(t)) - b(t)^2\chi''(xb(t)) - g(\chi(xb(t)))] \sin\left(\frac{\pi}{L}y + h\right) \\ &\leq (-\beta v_{\sigma+\varepsilon}(A_2) + B^2 \|\chi''\|_\infty) \sin\left(\frac{\pi}{L}y + h\right) \leq 0, \end{aligned}$$

from the choice done for B in (4.2.27).

– if $0 < y < L(1 - \frac{h}{\pi})$ and $|x| < A_1 b(t)^{-1}$:

$$\mathcal{L}_1(\underline{v})(x, y, t) = -g\left(\phi(A_1) \sin\left(\frac{\pi}{L}y + h\right)\right) \leq 0.$$

– if $y \geq L(1 - \frac{h}{\pi})$ and $x \in \mathbb{R}$:

$$\mathcal{L}_1(\underline{v})(x, y, t) = 0.$$

– On the road :

– if $|x| > A_2 b(t)^{-1}$, from the choice of $\tilde{\gamma}$ done in Lemma 4.2.1 and the fact that $g(s) \leq g'(0)s$ for $s \in [0, 1]$, we have

$$\begin{aligned} \mathcal{L}_2(\underline{v}, \underline{u})(x, t) &= c_h b'(t) x \phi'(xb(t)) + c_h b(t)^{2\alpha} (-\partial_{xx})^\alpha \phi(xb(t)) \\ &\quad + c_h (\mu + k) \phi(xb(t)) - \sin(h) \phi(xb(t)) \\ &\leq c_h g(\phi(xb(t))) + c_h (\mu + k + B^{2\alpha} D - \sin(h)) \phi(xb(t)) \\ &\leq [c_h (\tilde{\gamma} \sigma + \mu + k + B^{2\alpha} D) - \sin(h)] \phi(xb(t)) \\ &\leq 0, \end{aligned}$$

due to the choices of c_h and B respectively in (4.2.25) and (4.2.27).

– if $|x| \in (A_1 b(t)^{-1}, A_2 b(t)^{-1})$:

$$\begin{aligned} \mathcal{L}_2(\underline{v}, \underline{u})(x, t) &= c_h b'(t) x \phi'(xb(t)) + c_h b(t)^{2\alpha} (-\partial_{xx})^\alpha \phi(xb(t)) \\ &\quad + (c_h (\mu + k) - \sin(h)) \phi(xb(t)). \end{aligned}$$

We use two properties of the function ϕ defined in Lemma 4.2.1. First, the quantity

$$\|(-\partial_{xx})^\alpha \phi\|_\infty = \max_{|z| \leq A_2} |(-\partial_{xx})^\alpha \phi(z)| \quad (4.2.28)$$

is well defined since $\phi \in \mathcal{C}^2(\mathbb{R}) \cap L^\infty(\mathbb{R})$. Second, still from Lemma 4.2.1, the function $x \mapsto -x\phi'(x)$ is smaller than $\sigma A_2^{-\sigma}$ for such values of $|x|$.

With the choice done for c_h in (4.2.25), we get

$$\begin{aligned} \mathcal{L}_2(\underline{v}, \underline{u})(x, t) &\leq \gamma c_h \sigma A_2^{-\sigma} - \frac{\sin(h)}{2} \phi(A_2) + c_h B^{2\alpha} \|(-\partial_{xx})^\alpha \phi\|_\infty \\ &\leq -\frac{\sin(h)}{4} \phi(A_2) + c_h B^{2\alpha} \|(-\partial_{xx})^\alpha \phi\|_\infty \leq 0, \end{aligned}$$

thanks to the choice of B in (4.2.27).

- if $|x| \leq A_1 b(t)^{-1}$, from Lemma 4.2.1, $\phi'(xb(t)) = 0$ and with (4.2.28) we have

$$\begin{aligned} \mathcal{L}_2(\underline{v}, \underline{u})(x, t) &= c_h b(t)^{2\alpha} (-\partial_{xx})^\alpha \phi(xb(t)) + [c_h(\mu + k) - \sin(h)] \phi(xb(t)) \\ &\leq [c_h(\mu + k) - \sin(h)] \phi(xb(t)) + c_h B^{2\alpha} \|(-\partial_{xx})^\alpha \phi\|_\infty \\ &\leq -\frac{\sin(h)}{2} + c_h B^{2\alpha} \|(-\partial_{xx})^\alpha \phi\|_\infty. \\ &\leq 0, \end{aligned}$$

from the choices of c_h and B done respectively in (4.2.25) and in (4.2.27).

- The condition on the boundary gives, for all $x \in \mathbb{R}$,

$$\begin{aligned} -\partial_y \underline{v}(x, 0, t) - \mu \underline{u}(x, t) + \underline{v}(x, 0, t) &= \left(-\frac{\pi}{L} \cos(h) - \mu c_h + \sin(h)\right) \phi(xb(t)) \\ &\leq \left(-\frac{\pi}{L} + \tan(h)\right) \cos(h) \phi(xb(t)) \leq 0, \end{aligned}$$

due to the choice of h done in (4.2.25). ■

Step 4 : Taking into account the initial condition

We now turn to Step 3 of the method given in the introduction of the thesis, finding a time $t_0 > 0$ such that the couple $(\underline{v}, \underline{u})$ defined in (4.2.26) is smaller than the solution (v, u) at time t_0 . We set $t_0 = 2$ and define an intermediate couple (p^v, p^u) that is smaller than (v, u) and that decays like $|x|^{-(1+2\alpha)}$ for large values of $|x|$. Since the nonlinearity f is nonnegative, by the comparison principle stated in Theorem 3.4.3, we know that (v, u) is greater than (p^v, p^u) , the solution to

$$\begin{cases} \partial_t p^v - \Delta p^v = 0, & x \in \mathbb{R}, y > 0, t > 0, \\ \partial_t p^u + (-\partial_{xx})^\alpha p^u = -(\mu + k)p^u + p^v|_{y=0}, & x \in \mathbb{R}, y = 0, t > 0, \\ -\partial_y p^v|_{y=0} = \mu p^u - p^v|_{y=0}, & x \in \mathbb{R}, y = 0, t > 0, \end{cases}$$

with $p^v(\cdot, \cdot, 0) = 0$ and $p^u(\cdot, 0) = u_0$. Applying Lemma 4.2.2 with $Y = L$, we have the existence of a constant $a > 0$ such that, for all $x \in \mathbb{R}$ and all $y \in [0, L]$,

$$v(x, y, 2) \geq p^v(x, y, 2) \geq \frac{a}{1 + |x|^{1+2\alpha}}, \quad \text{and} \quad u(x, 2) \geq p^u(x, 2) \geq \frac{a}{1 + |x|^{1+2\alpha}}.$$

Since $s \mapsto \frac{f(s)}{s}$ is decreasing, there exists a small constant $\varepsilon_0 \in (0, 1)$ such that the couple $(\varepsilon_0 \underline{v}, \varepsilon_0 \underline{u})$ is a subsolution to the initial problem (4.1.1). Taking ε_0 smaller if

necessary, the decay and the continuity of ϕ imposed in Lemma 4.2.1 and the definition of $(\underline{v}, \underline{u})$ in (4.2.26), give for all $(x, y) \in \mathbb{R} \times [0, L]$

$$v(x, y, 2) \geq \frac{a}{1 + |x|^{1+2\alpha}} \geq \varepsilon_0 \underline{v}(x, y, 2), \quad \text{and} \quad u(x, 2) \geq \frac{a}{1 + |x|^{1+2\alpha}} \geq \varepsilon_0 \underline{u}(x, 2).$$

By Theorem 3.4.3, for all $t \geq 2$ and all $(x, y) \in \mathbb{R} \times \mathbb{R}_+$, we get

$$v(x, y, t) \geq \varepsilon_0 \underline{v}(x, y, t) \quad \text{and} \quad u(x, t) \geq \varepsilon_0 \underline{u}(x, t). \quad (4.2.29)$$

More precisely, since ϕ defined in Lemma 4.2.1 is even and nonincreasing in $|x|$, we have for $t \geq 2$ and $|x| \leq e^{\gamma t}$

$$u(x, t) \geq \varepsilon_0 \underline{u}(x, t) = \varepsilon_0 c_h \phi(xb(t)) \geq \varepsilon_0 c_h \phi(e^{\gamma t} b(t)) = \varepsilon_0 c_h \phi(B) > 0,$$

where $b(t)$ and B are given respectively in (4.2.26) and (4.2.27). Consequently, we have

$$\lim_{t \rightarrow +\infty} \inf_{|x| \leq e^{\gamma t}} u(x, t) > 0.$$

This result is true for all $\gamma \in \left(0, \frac{f'(0)}{1+2\alpha}\right)$, which concludes the proof of the first part of Theorem 4.1.2.

4.3 Construction of a supersolution

The nonlinearity of the initial problem (4.1.1) is a Fisher-KPP type nonlinearity, which imposes $f(v) \leq f'(0)v$. It is usual to consider as supersolution the solution (\bar{v}, \bar{u}) to the linear problem

$$\begin{cases} \partial_t \bar{v} - \Delta \bar{v} = f'(0)\bar{v}, & x \in \mathbb{R}, y > 0, t > 0, \\ \partial_t \bar{u} + (-\partial_{xx})^\alpha \bar{u} = -\mu \bar{u} + \bar{v}|_{y=0} - k\bar{u}, & x \in \mathbb{R}, y = 0, t > 0, \\ -\partial_y \bar{v}|_{y=0} = \mu \bar{u} - \bar{v}|_{y=0}, & x \in \mathbb{R}, y = 0, t > 0, \end{cases}$$

where $\mu > 0$, $k \geq 0$ and completed with initial conditions $\bar{v}(\cdot, \cdot, 0) = 0$ and $\bar{u}(\cdot, 0) = u_0$.

The following theorem is the key point to prove the second part of Theorem 4.1.2 that concerns the propagation on the road. It gives an upper estimate to the density \bar{u} . In the sequel, the constant $r_{0, k+f'(0)}$ defined in (3.3.4) as the solution to

$$r_{0, k+f'(0)}^2 = r_{0, k+f'(0)}^{2\alpha} + k + f'(0), \quad (4.3.1)$$

will be denoted by r_0 . It is crucial to notice that

$$r_0 > \sqrt{f'(0)}.$$

Theorem 4.3.1. *There exist $c \in \left(\frac{\sqrt{f'(0)}}{r_0}, 1 \right)$ and $\widetilde{C}_1 > 0$ such that for $|x| \geq 1$, we have*

$$\bar{u}(x, t) \leq \widetilde{C}_1 \left(\frac{e^{f'(0)t}}{|x|^{1+2\alpha} t^{3/2}} + R(x, t) \right),$$

with

$$R(x, t) \leq e^{(f'(0) - c^2 r_0^2 \cos(2\varepsilon))t} + e^{f'(0)t} e^{-\sqrt{|x|} \sin(\varepsilon)} + \frac{e^{f'(0)t}}{|x|^3} + e^{(f'(0) - r_0^2)t},$$

and $\varepsilon > 0$ satisfies $c^2 r_0^2 \cos(2\varepsilon) > f'(0)$.

This theorem emphasises that the dynamics of the level sets of \bar{u} , for large values of $|x|$ and t , is given by $\frac{e^{f'(0)t}}{|x|^{1+2\alpha} t^{3/2}}$.

We define

$$(\bar{v}_1, \bar{u}_1) = e^{-f'(0)t} (\bar{v}, \bar{u}), \quad (4.3.2)$$

the solution to

$$\begin{cases} \partial_t \bar{v}_1 - \Delta \bar{v}_1 = 0, & x \in \mathbb{R}, y > 0, t > 0, \\ \partial_t \bar{u}_1 + (-\partial_{xx})^\alpha \bar{u}_1 = -\mu \bar{u}_1 + \bar{v}_1|_{y=0} - k \bar{u}_1 - f'(0) \bar{u}_1, & x \in \mathbb{R}, y = 0, t > 0, \\ -\partial_y \bar{v}_1|_{y=0} = \mu \bar{u}_1 - \bar{v}_1|_{y=0}, & x \in \mathbb{R}, y = 0, t > 0, \end{cases} \quad (4.3.3)$$

with initial conditions $\bar{v}_1(\cdot, \cdot, 0) = 0$ and $\bar{u}_1(\cdot, 0) = u_0$. This Cauchy problem can be written

$$\partial_t \begin{pmatrix} \bar{v}_1 \\ \bar{u}_1 \end{pmatrix} + \tilde{A} \begin{pmatrix} \bar{v}_1 \\ \bar{u}_1 \end{pmatrix} = 0,$$

where

$$\tilde{A} \begin{pmatrix} \bar{v}_1 \\ \bar{u}_1 \end{pmatrix} = \begin{pmatrix} -\Delta \bar{v}_1 \\ (-\partial_{xx})^\alpha \bar{u}_1 + \mu \bar{u}_1 - \bar{v}_1|_{y=0} + k \bar{u}_1 + f'(0) \bar{u}_1 \end{pmatrix}. \quad (4.3.4)$$

The operator \tilde{A} is similar to the operator A defined in (3.3.1) with the constant k replaced by $k + f'(0)$. Its domain is $D(A)$ given by (3.3.2). The properties obtained on A in sections 3.3.2 and 3.3.3 do not depend on k . Thus, \tilde{A} is a sectorial operator on X with angle $\beta_{\tilde{A}}$ that can be taken anywhere in $(0, \frac{\pi}{2})$. From Theorem 3.2.4, the solution to (4.3.3) is given for all $(x, y) \in \mathbb{R} \times \mathbb{R}_+$ by

$$\begin{pmatrix} \bar{v}_1(x, y, t) \\ \bar{u}_1(x, t) \end{pmatrix} = \frac{1}{2i\pi} \int_{\Gamma_{0, \beta_{\tilde{A}}}} (\tilde{A} - \lambda I)^{-1} \begin{pmatrix} 0 \\ u_0(x) \end{pmatrix} e^{-\lambda t} d\lambda. \quad (4.3.5)$$

The complete proof of Theorem 4.3.1 is given in section 4.3.2. It is computationally difficult to obtain, but reveals some properties of the linear operator. The outline of the proof is the following.

1. We will compute $(\tilde{A} - \lambda I)^{-1} \begin{pmatrix} 0 \\ u_0 \end{pmatrix}$. This is an easy step that gives

$$(\tilde{A} - \lambda I)^{-1} \begin{pmatrix} 0 \\ u_0 \end{pmatrix} = \begin{pmatrix} \mathcal{F}^{-1} \left(\xi \mapsto \frac{\mu}{P(\lambda, |\xi|)} e^{-\sqrt{-\lambda + |\xi|^2} y} \right) \star u_0 \\ \mathcal{F}^{-1} \left(\xi \mapsto \frac{\sqrt{-\lambda + |\xi|^2 + 1}}{P(\lambda, |\xi|)} \right) \star u_0 \end{pmatrix}, \quad (4.3.6)$$

where P is the function $P_{k+f'(0)}$ defined in (3.3.3) by

$$P(\lambda, |\xi|) := (-\lambda + |\xi|^{2\alpha} + \mu + k + f'(0)) \left(\sqrt{-\lambda + |\xi|^2 + 1} \right) - \mu. \quad (4.3.7)$$

The preliminary lemma 4.3.2 simplifies the expression $\mathcal{F}^{-1} \left(\xi \mapsto \frac{\sqrt{-\lambda + |\xi|^2 + 1}}{P(\lambda, |\xi|)} \right)$ that appears in (4.3.6). The computation of this inverse Fourier transform requires the knowledge of the location of the zeroes of P , which has already been done in Lemma 3.3.1. Indeed we know that :

- if $|\xi| < r_0$, for any $\lambda \in \mathbb{C}$, $P(\lambda, |\xi|)$ does not vanish,
- if $|\xi| \geq r_0$, $P(\lambda, |\xi|)$ may vanish for some real values of λ .

2. An estimate of the integral on $\{|\xi| < r_0\}$ is inspired of [75] and given in Lemma 4.3.4.
3. The integral on $\{|\xi| \geq r_0\}$ can be bounded from above by $e^{-r_0^2 t}$. This is done in Lemma 4.3.5. Going back to the supersolution

$$\bar{u}(x, t) = e^{f'(0)t} \mathcal{F}^{-1} \left(\xi \mapsto \frac{\sqrt{-\lambda + |\xi|^2 + 1}}{P(\lambda, |\xi|)} \right) (x),$$

and since $r_0 > \sqrt{f'(0)}$, we understand that the integral on $\{|\xi| \geq r_0\}$ tends to 0 as t tends to $+\infty$.

4.3.1 Preliminary result : estimate of an integral

Lemma 4.3.2. *Let r_0 be defined in (4.3.1) and P be defined in (4.3.7). For $r \geq 0$, $t > 1$ and a constant $\beta \in (0, \frac{\pi}{2})$, we set*

$$I_\beta(r, t) = \frac{1}{i\pi} \int_{\Gamma_{0,\beta}} \frac{\sqrt{-\lambda + r^2 + 1}}{P(\lambda, r)} e^{-\lambda t} d\lambda, \quad (4.3.8)$$

where $\Gamma_{0,\beta} = \mathbb{R}_+ e^{i\beta} \oplus \mathbb{R}_+ e^{-i\beta}$. Then, for all $c \in (0, 1)$, the following two points are satisfied.

1. For $r \in (0, cr_0)$ and $t > 1$:

$$I_\beta(r, t) = \frac{2\mu e^{-r^2 t}}{\pi} \int_0^{+\infty} \frac{\sqrt{\nu}}{|P(r^2 + \nu, r)|^2} e^{-\nu t} d\nu,$$

where

$$P(r^2 + \nu, r) = (-\nu - r^2 + r^{2\alpha} + \mu + k + f'(0)) (i\sqrt{\nu} + 1) - \mu.$$

2. There exists a universal constant $C_4 > 0$ such that, for all $r \geq cr_0$ and all $t > 1$

$$|I_\beta(r, t)| \leq C_4 e^{-(r^{2\alpha} + k + f'(0) - \varepsilon_0)t} \left(\sqrt{|r^2 - (r^{2\alpha} + k + f'(0) - \varepsilon_0)|} + 1 \right), \quad (4.3.9)$$

where $\varepsilon_0 = r_0^{2\alpha}(1 - c^{2\alpha}) > 0$.

Proof : 1. Let c be in $(0, 1)$ and β_1 in $(0, \beta)$. Due to Lemma 3.3.1, for $\lambda \in \mathbb{C}$ and $r \in (0, cr_0)$, $P(\lambda, r)$ does not vanish. Consequently,

$$\lambda \mapsto \frac{\sqrt{-\lambda + r^2} + 1}{P(\lambda, r)} e^{-\lambda t}$$

is holomorphic in \mathbb{C} . Let $R > 0$ be any constant satisfying

$$\frac{R}{(R^2 + r^4 - 2r^2 R \cos(\beta_1))^{1/2}} \sin(\beta_1) < \frac{1}{\sqrt{2}}, \quad \text{uniformly in } r \in (0, cr_0).$$

We consider the contour of integration \mathcal{C}_1^R , oriented in the direct sense, defined by

$$\mathcal{C}_1^R := \Gamma_{0, \beta}^R \cup \{Re^{i\theta}, \theta \in (-\beta, -\beta_1)\} \cup \Gamma_{r^2, \tilde{\beta}}^{l(R, r)} \cup \{Re^{i\theta}, \theta \in (\beta_1, \beta)\},$$

where for all $r \in [0, cr_0]$, $l(R, r) = (R^2 + r^4 - 2r^2 R \cos(\beta_1))^{1/2}$, $\tilde{\beta}$ is such that $\sin(\tilde{\beta}) = \frac{R}{l(R, r)} \sin(\beta_1)$, and for all $\tilde{R} > 0$, $\Gamma_{\cdot, \cdot}^{\tilde{R}} = \{\lambda \in \Gamma_{\cdot, \cdot} \mid |\lambda| \leq \tilde{R}\}$. The expressions of $l(R, r)$ and $\tilde{\beta}$ are obtained by usual trigonometric identities.

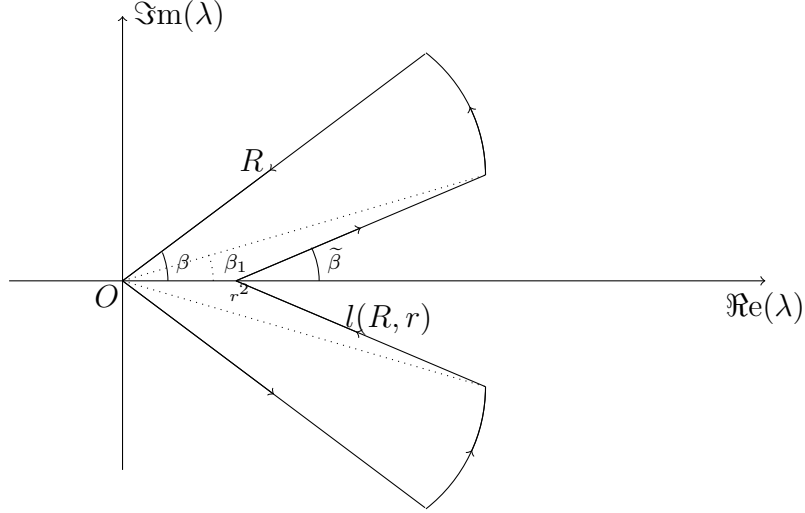
Oriented contour \mathcal{C}_1^R

Cauchy's formula gives for all $R > 0$

$$\begin{aligned}
 i\pi I_\beta(r, t) &= \int_{\Gamma_{r^2, \tilde{\beta}}^{l(R, r)}} \frac{\sqrt{-\lambda + r^2 + 1}}{P(\lambda, r)} e^{-\lambda t} d\lambda + \int_{-\beta_1}^{-\beta} \frac{\sqrt{-Re^{i\theta} + r^2 + 1}}{P(Re^{i\theta}, r)} e^{-Re^{i\theta} t} Re^{i\theta} i d\theta \\
 &\quad - \int_{\beta}^{\beta_1} \frac{\sqrt{-Re^{i\theta} + r^2 + 1}}{P(Re^{i\theta}, r)} e^{-Re^{i\theta} t} Re^{i\theta} i d\theta. \tag{4.3.10}
 \end{aligned}$$

The last two terms in the right hand side of (4.3.10) tend to 0 as R goes to $+\infty$. Indeed

$$\left| \int_{\pm\beta}^{\pm\beta_1} \frac{\sqrt{-Re^{i\theta} + r^2 + 1}}{P(Re^{i\theta}, r)} e^{-Re^{i\theta} t} Re^{i\theta} i d\theta \right| \leq C\sqrt{R}e^{-R\cos(\beta)t},$$

where $C > 0$ is a universal constant. Moreover we have for all $r \in (0, cr_0)$

$$l(R, r) \xrightarrow{R \rightarrow +\infty} +\infty.$$

Thus, passing to the limit as R tends to $+\infty$ in (4.3.10), we have for all $t > 1$ and $r \in (0, cr_0)$

$$I_\beta(r, t) = \frac{1}{i\pi} \int_{\Gamma_{r^2, \tilde{\beta}}} \frac{\sqrt{-\lambda + r^2 + 1}}{P(\lambda, r)} e^{-\lambda t} d\lambda.$$

A simple computation gives

$$i\pi e^{r^2 t} I_\beta(r, t) = - \int_0^{+\infty} \frac{i\sqrt{\nu} e^{i\frac{\tilde{\beta}}{2}} + 1}{P(r^2 + \nu e^{i\tilde{\beta}}, r)} e^{-\nu e^{i\tilde{\beta}} t + i\tilde{\beta}} d\nu + \int_0^{+\infty} \frac{-i\sqrt{\nu} e^{-i\frac{\tilde{\beta}}{2}} + 1}{P(r^2 + \nu e^{-i\tilde{\beta}}, r)} e^{-\nu e^{-i\tilde{\beta}} t - i\tilde{\beta}} d\nu.$$

The expressions to be integrated are conjugate, which gives

$$I_\beta(r, t) = -\frac{2e^{-r^2t}}{\pi} \int_0^{+\infty} \Im \left(\frac{i\sqrt{\nu}e^{i\tilde{\beta}/2} + 1}{P(r^2 + \nu e^{i\tilde{\beta}}, r)} e^{-\nu e^{i\tilde{\beta}}t} e^{i\tilde{\beta}} \right) d\nu.$$

There exists a constant $C > 0$ such that for all $\nu > 0$

$$\left| \Im \left(\frac{i\sqrt{\nu}e^{i\tilde{\beta}/2} + 1}{P(r^2 + \nu e^{i\tilde{\beta}}, r)} e^{-\nu e^{i\tilde{\beta}}t} e^{i\tilde{\beta}} \right) \right| \leq C(\sqrt{\nu} + 1)e^{-\frac{\nu}{\sqrt{2}}t}.$$

Consequently, for $r \in (0, cr_0)$ and $t > 1$, we can pass to the limit as $\tilde{\beta}$ tends to 0, applying the dominated convergence theorem. We get

$$\begin{aligned} I_\beta(r, t) &= -\frac{2e^{-r^2t}}{\pi} \int_0^{+\infty} \Im \left(\frac{i\sqrt{\nu} + 1}{P(r^2 + \nu, r)} \right) e^{-\nu t} d\nu \\ &= \frac{2\mu e^{-r^2t}}{\pi} \int_0^{+\infty} \frac{\sqrt{\nu}}{|P(r^2 + \nu, r)|^2} e^{-\nu t} d\nu. \end{aligned}$$

2. We prove the second point of the lemma. Let c be a constant in $(0, 1)$. From Lemma 3.3.1 we know that, for $r \geq r_0$, $P(\lambda, r)$ may vanish for certain real values of λ , that are greater than or equal to $r^{2\alpha} + k + f'(0)$. Consequently, for all $R > 0$, the function

$$\lambda \mapsto \frac{\sqrt{-\lambda + r^2} + 1}{P(\lambda, r)} e^{-\lambda t}$$

has no pole inside the contour \mathcal{C}_2^R (oriented in the direct sense) defined by

$$\begin{aligned} \mathcal{C}_2^R &:= \Gamma_{0,\beta}^R \cup \{Re^{i\beta} + \nu, \nu \in (0, r^{2\alpha} + k + f'(0) - \varepsilon_0)\} \cup \Gamma_{r^{2\alpha} + k + f'(0) - \varepsilon_0, \beta}^R \\ &\cup \{Re^{-i\beta} + \nu, \nu \in (0, r^{2\alpha} + k + f'(0) - \varepsilon_0)\}, \end{aligned}$$

where $\Gamma_{\cdot, \beta}^R = \{\lambda \in \Gamma_{\cdot, \beta} \mid |\lambda| \leq R\}$ and $\varepsilon_0 = r_0^{2\alpha}(1 - c^{2\alpha}) > 0$.

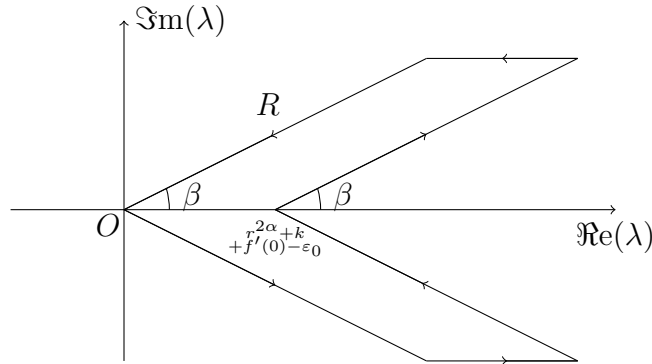

Oriented contour \mathcal{C}_2^R

We apply Cauchy's formula and, as in the case $r \in (0, cr_0)$, the integrals on the contours

$$\{Re^{i\beta} + \nu, \nu \in (0, r^{2\alpha} + k + f'(0) - \varepsilon_0)\} \quad \text{and} \quad \{Re^{-i\beta} + \nu, \nu \in (0, r^{2\alpha} + k + f'(0) - \varepsilon_0)\}$$

tend to 0 as R tends to $+\infty$. To estimate the integral on $\Gamma_{r^{2\alpha} + k + f'(0) - \varepsilon_0, \beta}^R$, we use Lemma 3.3.1 that gives the location of the zeroes of P . Indeed, if $\lambda \in \Gamma_{r^{2\alpha} + k + f'(0) - \varepsilon_0, \beta}^R$ and $r \geq cr_0$, then $P(\lambda, r) \geq c_P > 0$. Thus, we have for all $\nu \geq 0$, for all $r \geq cr_0$ and for $\lambda = r^{2\alpha} + k + f'(0) - \varepsilon_0 + \nu e^{\pm i\beta}$:

$$\left| \frac{\sqrt{-\lambda + r^2 + 1}}{P(\lambda, r)} \right| \leq c_P^{-1} \left(\sqrt{|r^2 - (r^{2\alpha} + k + f'(0) - \varepsilon_0)|} + \sqrt{\nu} + 1 \right).$$

This implies for all $r \geq cr_0$ and all $t > 1$:

$$\begin{aligned} |I_\beta(r, t)| &\leq \left| \frac{1}{i\pi} \int_{\Gamma_{r^{2\alpha} + k + f'(0) - \varepsilon_0, \beta}} \frac{\sqrt{-\lambda + r^2 + 1}}{P(\lambda, r)} e^{-\lambda t} d\lambda \right| \\ &\leq c_P^{-1} e^{-(r^{2\alpha} + k + f'(0) - \varepsilon_0)t} \left(\sqrt{|r^2 - (r^{2\alpha} + k + f'(0) - \varepsilon_0)|} + 1 \right) \int_0^{+\infty} e^{-\nu \cos(\beta)t} d\nu \\ &\quad + c_P^{-1} e^{-(r^{2\alpha} + k + f'(0) - \varepsilon_0)t} \int_0^{+\infty} \sqrt{\nu} e^{-\nu \cos(\beta)t} d\nu \\ &\leq C_4 e^{-(r^{2\alpha} + k + f'(0) - \varepsilon_0)t} \left(\sqrt{|r^2 - (r^{2\alpha} + k + f'(0) - \varepsilon_0)|} + 1 \right), \end{aligned}$$

where C_4 is positive universal constant. ■

4.3.2 Proof of Theorem 4.3.1

We follow the outline of the proof given at the beginning of the section.

1. *Computation of $(\tilde{A} - \lambda I)^{-1} \begin{pmatrix} 0 \\ u_0 \end{pmatrix}$, for $\lambda \in \Gamma_{0, \beta_{\tilde{A}}}$:*

For all $\lambda \in \Gamma_{0, \beta_{\tilde{A}}}$, we compute for $(x, y) \in \mathbb{R} \times \mathbb{R}_+$ the quantity

$$\begin{pmatrix} v_{\tilde{A}}(x, y) \\ u_{\tilde{A}}(x) \end{pmatrix} := (\tilde{A} - \lambda I)^{-1} \begin{pmatrix} 0 \\ u_0(x) \end{pmatrix}.$$

In other words, $(v_{\tilde{A}}, u_{\tilde{A}}) \in D(A)$ satisfies, almost everywhere in the (x, y) -variable,

$$\begin{cases} -\Delta v_{\tilde{A}} = \lambda v_{\tilde{A}}, & x \in \mathbb{R}, y > 0, \\ (-\partial_{xx})^\alpha u_{\tilde{A}} + \mu u_{\tilde{A}} - v_{\tilde{A}} + k u_{\tilde{A}} + f'(0) u_{\tilde{A}} = \lambda u_{\tilde{A}} + u_0, & x \in \mathbb{R}, y = 0, \\ -\partial_y v_{\tilde{A}} = \mu u_{\tilde{A}} - v_{\tilde{A}} & x \in \mathbb{R}, y = 0. \end{cases}$$

Taking the Fourier transform in the x -variable, we have, almost everywhere in the (ξ, y) -variable,

$$\begin{cases} -\partial_{yy}\widehat{v}_{\tilde{A}} = (\lambda - |\xi|^2)\widehat{v}_{\tilde{A}}, & \xi \in \mathbb{R}, y > 0, \\ -\widehat{v}_{\tilde{A}} + (-\lambda + |\xi|^{2\alpha} + \mu + k + f'(0))\widehat{u}_{\tilde{A}} = \widehat{u}_0, & \xi \in \mathbb{R}, y = 0, \\ -\partial_y\widehat{v}_{\tilde{A}} + \widehat{v}_{\tilde{A}} = \mu\widehat{u}_{\tilde{A}}, & \xi \in \mathbb{R}, y = 0. \end{cases} \quad (4.3.11)$$

Since $v_{\tilde{A}}$ is in $H^2(\mathbb{R} \times \mathbb{R}_+)$, $\lambda - |\xi|^2 \notin \mathbb{R}^{*-}$ and the first equation of (4.3.11) gives, for almost every $\xi \in \mathbb{R}$ and almost every $y \geq 0$:

$$\widehat{v}_{\tilde{A}}(\xi, y) = \gamma_0 \widehat{v}_{\tilde{A}}(\xi) e^{-\sqrt{|\xi|^2 - \lambda} y}. \quad (4.3.12)$$

Once we have $\widehat{v}_{\tilde{A}}$, the third equation of (4.3.11) implies for almost every $\xi \in \mathbb{R}$

$$\gamma_0 \widehat{v}_{\tilde{A}}(\xi) = \frac{\mu}{1 + \sqrt{|\xi|^2 - \lambda}} \widehat{u}_{\tilde{A}}(\xi). \quad (4.3.13)$$

Finally, for almost every $\xi \in \mathbb{R}$, the second equation of (4.3.11) leads to

$$\left(-\frac{\mu}{1 + \sqrt{|\xi|^2 - \lambda}} - \lambda + |\xi|^{2\alpha} + \mu + k + f'(0) \right) \widehat{u}_{\tilde{A}}(\xi) = \widehat{u}_0(\xi). \quad (4.3.14)$$

With the definition of P defined in (4.3.7), equality (4.3.14) becomes

$$\frac{P(\lambda, |\xi|)}{1 + \sqrt{|\xi|^2 - \lambda}} \widehat{u}_{\tilde{A}}(\xi) = \widehat{u}_0(\xi), \quad \text{for almost every } \xi \in \mathbb{R}. \quad (4.3.15)$$

From Lemma 3.3.1, if $\lambda \in \mathbb{C} \setminus S_{0, \beta_{\tilde{A}}}$ then for almost every $\xi \in \mathbb{R}$, $P(\lambda, |\xi|) \neq 0$. This fact and equations (4.3.12), (4.3.13), (4.3.15) imply

$$\left(\tilde{A} - \lambda I \right)^{-1} \begin{pmatrix} 0 \\ u_0(x) \end{pmatrix} = \begin{pmatrix} \mathcal{F}^{-1} \left(\xi \mapsto \frac{\mu}{P(\lambda, |\xi|)} e^{-\sqrt{-\lambda + |\xi|^2} y} \right) \star u_0(x) \\ \mathcal{F}^{-1} \left(\xi \mapsto \frac{\sqrt{-\lambda + |\xi|^2 + 1}}{P(\lambda, |\xi|)} \right) \star u_0(x) \end{pmatrix}. \quad (4.3.16)$$

We will see later that we only need to assume $u_0 = \delta_0$. Thus, using (4.3.5) and (4.3.16), we need to compute

$$\frac{1}{2i\pi} \int_{\Gamma_{0, \beta_{\tilde{A}}}} \int_{\mathbb{R}} \frac{\sqrt{-\lambda + |\xi|^2 + 1}}{P(\lambda, |\xi|)} e^{ix\xi} e^{-\lambda t} d\xi d\lambda.$$

It can also be written

$$\frac{1}{i\pi} \int_{\Gamma_{0,\beta_{\bar{A}}}} \int_0^{+\infty} \frac{\sqrt{-\lambda + r^2 + 1}}{P(\lambda, r)} e^{-\lambda t} \cos(xr) dr d\lambda.$$

We can notice that this function is even in the x variable that is why, from now on, we consider $x > 0$. The following lemma proves we can switch the order of integration.

Lemma 4.3.3. *For all $x > 0$, we have*

$$\int_{\Gamma_{0,\beta_{\bar{A}}}} \int_0^{+\infty} g_\lambda(r) e^{-\lambda t} \cos(xr) dr d\lambda = \int_0^{+\infty} \int_{\Gamma_{0,\beta_{\bar{A}}}} g_\lambda(r) e^{-\lambda t} \cos(xr) d\lambda dr,$$

where, for $\lambda \in \Gamma_{0,\beta_{\bar{A}}}$ and $r \geq 0$, $g_\lambda(r) = \frac{\sqrt{-\lambda + r^2 + 1}}{P(\lambda, r)}$.

Proof : If $2\alpha > 1$, for any λ in $\Gamma_{0,\beta_{\bar{A}}}$, the function

$$g_\lambda : r \mapsto \frac{\sqrt{-\lambda + r^2 + 1}}{P(\lambda, r)}$$

defined on \mathbb{R}_+ is integrable on \mathbb{R}_+ since it is continuous and equivalent to $r^{-2\alpha}$ for large values of r . Thus, we can apply Fubini's theorem to conclude the proof.

If $0 < 2\alpha \leq 1$, we use an integration by parts before applying Fubini's theorem. We can not do it directly because the function $r \mapsto \sqrt{-\lambda + r^2}$ is not $\mathcal{C}^1(\mathbb{R}_+)$ for all $\lambda \in \Gamma_{0,\beta_{\bar{A}}}$. We need to change the contour of integration $\Gamma_{0,\beta_{\bar{A}}}$. We set $\delta > 0$, $\eta > 0$ and define the contour $\mathcal{C}_3^{\eta,R}$, oriented in the direct sense, by

$$\begin{aligned} \mathcal{C}_3^{\eta,R} := & \Gamma_{0,\beta_{\bar{A}}}^{\eta,R} \cup \{\eta e^{i\theta}, \theta \in (\beta_{\bar{A}}, 2\pi - \beta_{\bar{A}})\} \cup \{R e^{i\beta_{\bar{A}}} + \nu, \nu \in (-\delta, 0)\} \cup \Gamma_{-\delta,\beta_{\bar{A}}}^R \\ & \cup \{R e^{-i\beta_{\bar{A}}} + \nu, \nu \in (-\delta, 0)\}, \end{aligned}$$

where $\Gamma_{0,\beta_{\bar{A}}}^{\eta,R} = \{\lambda \in \Gamma_{0,\beta_{\bar{A}}} \mid \eta \leq |\lambda| \leq R\}$ and $\varepsilon_0 = r_0^{2\alpha}(1 - c^{2\alpha}) > 0$.

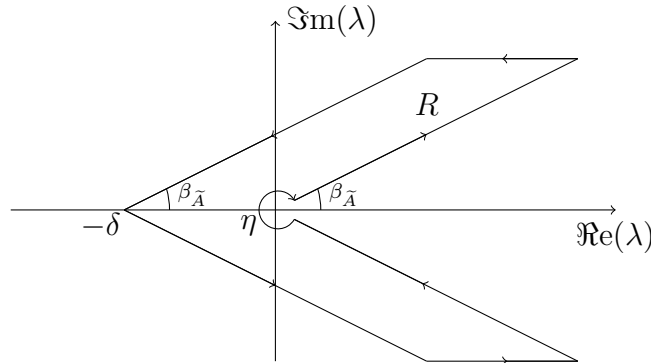

Oriented contour $\mathcal{C}_3^{\eta,R}$

Using Lemma 3.3.1 and Cauchy's formula (as done in the proof of Lemma 4.3.2), we have

$$\begin{aligned}
\int_{\Gamma_{0,\beta\bar{A}}^{\eta,R}} \int_0^{+\infty} g_\lambda(r) \cos(xr) e^{-\lambda t} dr d\lambda &= \int_{\Gamma_{-\delta,\beta\bar{A}}^R} \int_0^{+\infty} g_\lambda(r) \cos(xr) e^{-\lambda t} dr d\lambda \\
&+ \int_{-\delta}^0 \int_0^{+\infty} g_{\lambda_\nu}(r) \cos(xr) e^{-Re^{i\beta\bar{A}}t} e^{-\nu t} dr d\nu \\
&- \int_{-\delta}^0 \int_0^{+\infty} g_{\bar{\lambda}_\nu}(r) \cos(xr) e^{-Re^{-i\beta\bar{A}}t} e^{-\nu t} dr d\nu \\
&+ \int_{\beta\bar{A}}^{2\pi-\beta\bar{A}} \int_0^{+\infty} g_{\eta e^{i\theta}}(r) \cos(xr) e^{-\eta e^{i\theta}t} \eta e^{i\theta} i dr d\theta,
\end{aligned}$$

where $\lambda_\nu = Re^{i\beta\bar{A}} + \nu$.

A similar proof as the one done to pass to the limit in (4.3.10), proves that the three last terms tend to 0 as R goes to $+\infty$ and η goes to 0. Consequently we have

$$\int_{\Gamma_{0,\beta\bar{A}}} \int_0^{+\infty} g_\lambda(r) \cos(xr) e^{-\lambda t} dr d\lambda = \int_{\Gamma_{-\delta,\beta\bar{A}}} \int_0^{+\infty} g_\lambda(r) \cos(xr) e^{-\lambda t} dr d\lambda.$$

For any λ in $\Gamma_{-\delta,\beta\bar{A}}$, $\lim_{r \rightarrow +\infty} g_\lambda(r) = 0$ and thus, an integration by part gives

$$\int_0^{+\infty} g_\lambda(r) \cos(xr) dr = -\frac{1}{x} \int_0^{+\infty} g'_\lambda(r) \sin(xr) dr, \quad (4.3.17)$$

where

$$g'_\lambda(r) = \frac{-\mu r}{\sqrt{-\lambda + r^2} P(\lambda, r)^2} - \frac{2\alpha r^{2\alpha-1} (\sqrt{-\lambda + r^2} + 1)^2}{P(\lambda, r)^2}.$$

The function g'_λ is continuous on \mathbb{R}_+ and equivalent to $r^{-2\alpha-1}$ as r tends to $+\infty$. Consequently, it is integrable on \mathbb{R}_+ and, by Fubini's theorem, we have

$$\int_{\Gamma_{-\delta,\beta\bar{A}}} \int_0^{+\infty} g'_\lambda(r) \sin(xr) e^{-\lambda t} dr d\lambda = \int_0^{+\infty} \left(\int_{\Gamma_{-\delta,\beta\bar{A}}} g'_\lambda(r) e^{-\lambda t} d\lambda \right) \sin(xr) dr. \quad (4.3.18)$$

It is clear that for all $r \geq 0$:

$$\int_{\Gamma_{-\delta,\beta\bar{A}}} g'_\lambda(r) e^{-\lambda t} d\lambda = \left(\int_{\Gamma_{-\delta,\beta\bar{A}}} g_\lambda(r) e^{-\lambda t} d\lambda \right)'.$$

Consequently, using (4.3.17), (4.3.18) and the following limit

$$\lim_{r \rightarrow +\infty} \int_{\Gamma_{-\delta, \beta}} g_\lambda(r) e^{-\lambda t} d\lambda = 0,$$

we can integrate by parts once again to get

$$\begin{aligned} \int_{\Gamma_{-\delta, \beta_{\bar{A}}}} \int_0^{+\infty} g_\lambda(r) \cos(xr) e^{-\lambda t} dr d\lambda &= \frac{1}{x} \int_{\Gamma_{-\delta, \beta_{\bar{A}}}} \int_0^{+\infty} g'_\lambda(r) \sin(xr) e^{-\lambda t} dr d\lambda \\ &= -\frac{1}{x} \int_0^{+\infty} \left(\int_{\Gamma_{-\delta, \beta_{\bar{A}}}} g_\lambda(r) e^{-\lambda t} d\lambda \right)' \sin(xr) dr \\ &= \int_0^{+\infty} \int_{\Gamma_{-\delta, \beta_{\bar{A}}}} g_\lambda(r) e^{-\lambda t} d\lambda \cos(xr) dr. \end{aligned}$$

To conclude the proof, we use similar arguments, with Cauchy's formula, to turn the contour into $\Gamma_{0, \beta_{\bar{A}}}$. ■

With this Lemma 4.3.3 and the definition of I_β given in Lemma 4.3.2, the problem is now to find an upper bound to the real part of

$$\int_0^{+\infty} I_{\beta_{\bar{A}}}(r, t) e^{ixr} dr.$$

Fix a constant c such that

$$c \in \left(\frac{\sqrt{f'(0)}}{r_0}, 1 \right), \quad (4.3.19)$$

and, for $x > 0$ and $t > 0$, cut the integral into two pieces $J(x, t)$ and $K(x, t)$ as follows

$$J(x, t) := \int_0^{cr_0} I_{\beta_{\bar{A}}}(r, t) e^{ixr} dr \quad \text{and} \quad K(x, t) := \int_{cr_0}^{+\infty} I_{\beta_{\bar{A}}}(r, t) e^{ixr} dr. \quad (4.3.20)$$

Thus, the function \bar{u} given in (4.3.2) can be written

$$\bar{u}(x, t) = e^{f'(0)t} \Re e(J(x, t) + K(x, t)). \quad (4.3.21)$$

We have to estimate J and K , which is done in the following two lemmas.

2. *Estimate of the integral on $\{|\xi| \leq cr_0\}$:*

Lemma 4.3.4. *Let J be defined in (4.3.20). There exist $x_1 > 0$ and a universal constant $C_2 > 0$ such that, for $t > 1$ and $x > x_1$,*

$$|J(x, t)| \leq C_2 \left(e^{-c^2 r_0^2 \cos(2\varepsilon)t} + e^{-\sqrt{x} \sin(\varepsilon)} + \frac{1}{x^3} + \frac{1}{x^{1+2\alpha} t^{3/2}} \right),$$

where c is defined in (4.3.19) and $\varepsilon > 0$ satisfies $c^2 r_0^2 \cos(2\varepsilon) > f'(0)$.

Proof : From Lemma 4.3.2, we know that for $r \in (0, cr_0)$ and $t > 1$,

$$I_{\beta_{\bar{A}}}(r, t) = \frac{2\mu e^{-r^2 t}}{\pi} \int_0^{+\infty} \frac{\sqrt{\nu}}{|P(r^2 + \nu, r)|^2} e^{-\nu t} d\nu,$$

where

$$P(r^2 + \nu, r) = (-\nu - r^2 + r^{2\alpha} + \mu + k + f'(0))(i\sqrt{\nu} + 1) - \mu.$$

We define, for $(\nu, z) \in \mathbb{R}_+ \times \mathbb{C}$:

$$Q(\nu, z) = (-\nu - z^2 + z^{2\alpha} + k + f'(0))^2 + \nu(-\nu - z^2 + z^{2\alpha} + \mu + k + f'(0))^2, \quad (4.3.22)$$

so that we have

$$Q(\nu, r) = |P(r^2 + \nu, r)|^2 \quad \text{for } (\nu, r) \in \mathbb{R}_+ \times [0, cr_0]. \quad (4.3.23)$$

Thus, J becomes

$$J(x, t) := \frac{2\mu}{\pi} \int_0^{cr_0} e^{-r^2 t} e^{ixr} j(r, t) dr, \quad (4.3.24)$$

where

$$j(r, t) = \int_0^{+\infty} \frac{\sqrt{\nu}}{Q(\nu, r)} e^{-\nu t} d\nu.$$

To estimate J , we are inspired by the computations done by Polya in [75] and Kolokoltsov in [62]: three steps are required. The first one consists in rotating the integration line of a small angle $\varepsilon > 0$. Then, we prove we can only keep values of r close to 0. Finally, we rotate the integration line up to $\frac{\pi}{2}$.

Step 1 : The function Q is continuous on $\mathbb{R}_+ \times \mathbb{C}$, holomorphic in its second argument and, from Lemma 3.3.1, does not vanish on $\mathbb{R}_+ \times [0, cr_0]$. Moreover, from (4.3.22), we have, for z in any fixed compact

$$Q(\nu, z) \underset{\nu \rightarrow +\infty}{\sim} \nu^3.$$

Consequently, there exists a small angle $\varepsilon > 0$ such that

$$\cos(2\varepsilon) > \frac{f'(0)}{c^2 r_0^2}. \quad (4.3.25)$$

and

$$\text{for all } \nu \geq 0 \text{ and } z \in \{z \in \mathbb{C} \mid |z| \leq cr_0, \arg(z) \in [0, \varepsilon]\} : |Q(\nu, z)| \geq c_Q. \quad (4.3.26)$$

We want to rotate the integration line of ε in (4.3.24). For all $t > 1$, the function

$$z \mapsto e^{-z^2 t} e^{ixz} j(z, t)$$

is holomorphic on the same set as Q , that is to say on $\{z \in \mathbb{C} \mid |z| \leq cr_0, \arg(z) \in [0, \varepsilon]\}$ if $\alpha \in [\frac{1}{2}, 1)$, and on $\{z \in \mathbb{C} \setminus \{0\} \mid |z| \leq cr_0, \arg(z) \in [0, \varepsilon]\}$ if $\alpha \in (0, \frac{1}{2}]$. In this last case, we need to remove a neighbourhood of zero when rotating the integration line.

Let $\delta \in (0, cr_0)$. On the small arc $\gamma_{\delta, \varepsilon} = \{\delta e^{i\theta}, \theta \in [0, \varepsilon]\}$, we have for $t > 1$

$$\int_{\gamma_{\delta, \varepsilon}} \left| e^{-z^2 t} e^{ixz} j(z, t) \right| dz \leq C \int_0^\varepsilon e^{-\delta^2 \cos(2\theta)t} e^{-x\delta \sin(\theta)} \delta d\theta,$$

where $C > 0$ is a universal constant. The right hand side tends to 0 as δ tends to 0.

Thus, Cauchy's formula leads to

$$J(x, t) = \frac{2\mu}{\pi} (J_1(x, t) - J_2(x, t)), \quad (4.3.27)$$

where

$$J_1(x, t) := \int_0^{cr_0} e^{-s^2 e^{2i\varepsilon} t} e^{ixse^{i\varepsilon}} j(se^{i\varepsilon}, t) e^{i\varepsilon} ds$$

and

$$J_2(x, t) := cr_0 i \int_0^\varepsilon e^{-c^2 r_0^2 e^{2i\theta} t} e^{ixcr_0 e^{i\theta}} j(cr_0 e^{i\theta}, t) e^{i\theta} d\theta.$$

The term J_2 decays exponentially in time :

$$\begin{aligned} |J_2(x, t)| &\leq cr_0 \int_0^\varepsilon e^{-c^2 r_0^2 \cos(2\theta)t} e^{-xcr_0 \sin(\theta)} |j(cr_0 e^{i\theta}, t)| d\theta \\ &\leq \frac{C}{t^{3/2}} e^{-c^2 r_0^2 \cos(2\varepsilon)t}, \end{aligned} \quad (4.3.28)$$

where $C > 0$ is a universal constant linked to c_Q defined in (4.3.26).

Step 2 : We now treat J_1 . We cut it into two pieces in order to keep values of s close to 0. Let us define, for $x > (cr_0)^{-2}$ and $t > 1$:

$$J_1^m(x, t) := \int_0^{x^{-1/2}} e^{-s^2 e^{2i\varepsilon} t} e^{ixse^{i\varepsilon}} j(se^{i\varepsilon}, t) e^{i\varepsilon} ds \quad (4.3.29)$$

and

$$J_1^r(x, t) := \int_{x^{-1/2}}^{cr_0} e^{-s^2 e^{2i\varepsilon} t} e^{ixse^{i\varepsilon}} j(se^{i\varepsilon}, t) e^{i\varepsilon} ds,$$

so that

$$J_1(x, t) = J_1^m(x, t) + J_1^r(x, t). \quad (4.3.30)$$

For $x > (cr_0)^{-2}$ and $t > 1$, we have the estimate

$$|J_1^r(x, t)| \leq C \int_{x^{-1/2}}^{cr_0} e^{-xs \sin(\varepsilon)} e^{-s^2 \cos(2\varepsilon)t} ds,$$

where $C > 0$ is a universal constant linked to c_Q defined in (4.3.26). This implies that $J_1^r(x, t)$ decays exponentially in x and, taking C larger if necessary, for $x > (cr_0)^2$ and $t > 1$:

$$|J_1^r(x, t)| \leq C e^{-\sqrt{x} \sin(\varepsilon)}. \quad (4.3.31)$$

Step 3 : We prove that $J_1^m(x, t)$ decays like $x^{-(1+2\alpha)}$ for large values of x . We turn the integration variable into $\tilde{s} = xs$ to get, for $x > (cr_0)^2$ and $t > 1$,

$$J_1^m(x, t) = \int_0^{x^{1/2}} e^{-\frac{\tilde{s}^2}{x^2} e^{2i\varepsilon} t} e^{i\tilde{s}e^{i\varepsilon}} j(\tilde{s}x^{-1}e^{i\varepsilon}, t) e^{i\varepsilon} \frac{d\tilde{s}}{x}.$$

Keeping in mind that we want an estimate for large values of x , we cut J_1^m as follows

$$J_1^m(x, t) = \int_0^{x^{1/2}} e^{i\tilde{s}e^{i\varepsilon}} j(\tilde{s}x^{-1}e^{i\varepsilon}, t) e^{i\varepsilon} \frac{d\tilde{s}}{x} + \int_0^{x^{1/2}} (e^{-\frac{\tilde{s}^2}{x^2} e^{2i\varepsilon} t} - 1) e^{i\tilde{s}e^{i\varepsilon}} j(\tilde{s}x^{-1}e^{i\varepsilon}, t) e^{i\varepsilon} \frac{d\tilde{s}}{x}.$$

The second term in the right hand side satisfies

$$\left| \int_0^{x^{1/2}} (e^{-\frac{\tilde{s}^2}{x^2} e^{2i\varepsilon} t} - 1) e^{i\tilde{s}e^{i\varepsilon}} j(\tilde{s}x^{-1}e^{i\varepsilon}, t) e^{i\varepsilon} \frac{d\tilde{s}}{x} \right| \leq \frac{C}{x^3} \int_0^{+\infty} \tilde{s}^2 e^{-\tilde{s} \sin(\varepsilon)} d\tilde{s}, \quad (4.3.32)$$

where $C > 0$ is a universal constant. We have to estimate

$$\int_0^{x^{1/2}} e^{i\tilde{s}e^{i\varepsilon}} j(\tilde{s}x^{-1}e^{i\varepsilon}, t) e^{i\varepsilon} \frac{d\tilde{s}}{x}$$

for large values of x and $t > 1$, where we recall the expression of j in \mathbb{R}_+^2 :

$$j(r, t) = \int_0^{+\infty} \frac{\sqrt{\nu}}{Q(\nu, r)} e^{-\nu t} d\nu.$$

The function Q is continuous on $\mathbb{R}_+ \times \mathbb{C}$, is holomorphic in its second argument and, from Lemma 3.3.1, for all $\nu \in \mathbb{R}_+$, $Q(\nu, 0) \neq 0$. Moreover, from (4.3.22), we have, for z in any fixed compact

$$Q(\nu, z) \underset{\nu \rightarrow +\infty}{\sim} \nu^3.$$

Consequently, there exists $x_0 \in (0, 1)$ such that Q does not vanish in $\mathbb{R}_+ \times B_{x_0}(0)$. Thus, for all $t > 1$ and all $x^{-1/2} < x_0$, the function

$$z \mapsto e^{iz} j(zx^{-1}, t)$$

is holomorphic on $\{z \in \mathbb{C} \mid |z| \leq x^{1/2}\}$ if $\alpha \in [\frac{1}{2}, 1)$, and on $\{z \in \mathbb{C} \setminus \{0\} \mid |z| \leq x^{1/2}\}$ if $\alpha \in (0, \frac{1}{2}]$.

Let $\delta \in (0, 1)$. On the small arc $\gamma_\delta = \{\delta e^{i\theta}, \theta \in [\varepsilon, \frac{\pi}{2}]\}$, we have for $t > 1$

$$\int_{\gamma_\delta} |e^{iz} j(zx^{-1}, t)| dz \leq C \int_\varepsilon^{\frac{\pi}{2}} e^{-\delta \sin(\theta)} \delta d\theta.$$

The right hand side tends to 0 as δ tends to 0. For $x > x_0^{-2}$, we can rotate the integration line up to $\frac{\pi}{2}$ and Cauchy's formula leads to

$$\int_0^{x^{1/2}} e^{i\tilde{s}e^{i\varepsilon}} j(\tilde{s}x^{-1}e^{i\varepsilon}, t) e^{i\varepsilon} \frac{d\tilde{s}}{x} = \int_0^{x^{1/2}} e^{-s} j(isx^{-1}, t) i \frac{ds}{x} + \int_\varepsilon^{\frac{\pi}{2}} e^{ix^{1/2}e^{i\theta}} j(x^{1/2}e^{i\theta}, t) ie^{i\theta} \frac{d\theta}{x^{1/2}}.$$

The second term in the right hand side satisfies

$$\left| \int_\varepsilon^{\frac{\pi}{2}} e^{ix^{1/2}e^{i\theta}} j(x^{1/2}e^{i\theta}, t) ie^{i\theta} \frac{d\tilde{s}}{x^{1/2}} \right| \leq C e^{-\sqrt{x} \sin(\varepsilon)}, \quad (4.3.33)$$

where $C > 0$ is a universal constant. It remains to estimate \tilde{J}_1^m defined by

$$\tilde{J}_1^m(x, t) = \int_0^{x^{1/2}} e^{-s} j(isx^{-1}, t) i \frac{ds}{x},$$

where

$$j(isx^{-1}, t) = \int_0^{+\infty} \frac{\sqrt{\nu}}{Q(\nu, isx^{-1})} e^{-\nu t} d\nu.$$

Recall that we are interested in the real part of \tilde{J}_1^m . A simple computation gives

$$\begin{aligned} & |Q(\nu, isx^{-1})|^2 \Re \left(\frac{i}{Q(\nu, isx^{-1})} \right) = |Q(\nu, isx^{-1})|^2 \Im \left(\frac{1}{Q(\nu, isx^{-1})} \right) \\ & = 2 \frac{s^{2\alpha}}{x^{2\alpha}} \sin(\alpha\pi) [(-\nu + s^2 x^{-2} + k + f'(0) + \mu)(1 + \nu) - \mu] + \frac{s^{4\alpha}}{x^{4\alpha}} \sin(2\alpha\pi)(1 + \nu). \end{aligned}$$

The integral under study is

$$\Re \left(\tilde{J}_1^m(x, t) \right) = \int_0^{x^{1/2}} e^{-s} \int_0^{+\infty} \Im \left(\frac{1}{Q(\nu, isx^{-1})} \right) \sqrt{\nu} e^{-\nu t} d\nu \frac{ds}{x}.$$

With the dominated convergence theorem, we get

$$\lim_{x \rightarrow +\infty} x^{1+2\alpha} \Re \left(\tilde{J}_1^m(x, t) \right) = 2 \int_0^{+\infty} e^{-s} s^{2\alpha} \sin(\alpha\pi) h(t) ds,$$

where h is defined by

$$h(t) = \int_0^{+\infty} \frac{(-\nu + k + f'(0) + \mu)(1 + \nu) - \mu}{|Q(\nu, 0)|^2} \sqrt{\nu} e^{-\nu t} d\nu \underset{t \rightarrow +\infty}{\sim} \frac{\Gamma(3/2)}{(k + f'(0))^3 t^{3/2}}.$$

This implies that

$$\lim_{t \rightarrow +\infty} \lim_{x \rightarrow +\infty} t^{3/2} x^{1+2\alpha} \Re \left(\tilde{J}_1^m(x, t) \right) = \frac{4\alpha \sin(\alpha\pi) \Gamma(2\alpha) \Gamma(3/2)}{(k + f'(0))^3}. \quad (4.3.34)$$

Finally with (4.3.30), (4.3.31), (4.3.32), (4.3.33) and (4.3.34), we have the existence of a constant $x_1 > \max(x_0^{-2}, cr_0, (cr_0)^{-2})$ such that, for all $x > x_1$ and all $t > 1$:

$$\begin{aligned} |J_1(x, t)| &\leq |J_1^m(x, t)| + |J_1^r(x, t)| \\ &\leq C \left(e^{-\sqrt{x} \sin(\varepsilon)} + \frac{1}{x^3} + \frac{1}{x^{1+2\alpha} t^{3/2}} \right), \end{aligned}$$

where $C > 0$ is a universal constant. This estimate added to (4.3.27) and (4.3.28) lead to the existence of a constant $C_2 > 0$ such that, for $x > x_1$ and $t > 1$,

$$\begin{aligned} |J(x, t)| &\leq \frac{2\mu}{\pi} (|J_1(x, t)| + |J_2(x, t)|) \\ &\leq C_2 \left(e^{-c^2 r_0^2 \cos(2\varepsilon)t} + e^{-\sqrt{x} \sin(\varepsilon)} + \frac{1}{x^3} + \frac{1}{x^{1+2\alpha} t^{3/2}} \right), \end{aligned}$$

which proves Lemma 4.3.4. ■

Lemma 4.3.5. *Let K be defined in (4.3.20). There exist a universal constant $C_3 > 0$ and a time $t_0 > 0$ such that, for all $x > 0$ and $t > t_0$,*

$$K(x, t) \leq C_3 e^{-r_0^2 t}.$$

Proof : From Lemma 4.3.2, we know that for $r \geq cr_0$ and $t > 1$, there exists a universal constant $C_4 > 0$ such that for all $\beta \in (0, \frac{\pi}{2})$

$$|I_\beta(r, t)| \leq C_4 e^{-(r^{2\alpha} + k + f'(0) - \varepsilon_0)t} (\sqrt{|r^2 - (r^{2\alpha} + k + f'(0) - \varepsilon_0)|} + 1),$$

with $\varepsilon_0 = r_0^{2\alpha} (1 - c^{2\alpha})$. Consequently, there exists $t_0 > 0$ such that for $t > t_0$:

$$\begin{aligned} |K(x, t)| &\leq C_4 e^{-(k+f'(0)-\varepsilon_0)t} \int_{cr_0}^{+\infty} e^{-r^{2\alpha}t} (\sqrt{|r^2 - (r^{2\alpha} + k + f'(0) - \varepsilon)|} + 1) dr \\ &\leq C e^{-(c^{2\alpha}r_0^{2\alpha} + k + f'(0) - \varepsilon_0)t} \leq C_3 e^{-r_0^2 t}, \end{aligned}$$

where $C > 0$ and $C_3 > 0$ are universal constants. \blacksquare

The expression of \bar{u} obtained in (4.3.21) added to Lemma 4.3.4 and Lemma 4.3.5 enable us to conclude that there exists a constant $C_1 > 0$ such that for $|x| > x_1$ and $t > t_0$

$$\bar{u}(x, t) \leq C_1 \left(e^{(f'(0) - c^2 r_0^2 \cos(2\varepsilon))t} + e^{f'(0)t} e^{-\sqrt{|x|} \sin(\varepsilon)} + \frac{e^{f'(0)t}}{|x|^3} + \frac{e^{f'(0)t}}{|x|^{1+2\alpha} t^{3/2}} + e^{(f'(0) - r_0^2)t} \right).$$

In the more general case when u_0 is any compactly supported initial datum, the expressions (4.3.2), (4.3.5) and (4.3.16) give

$$\bar{u}(x, t) = \frac{e^{f'(0)t}}{2i\pi} \int_{\Gamma_{0, \beta \tilde{A}}} \mathcal{F}^{-1} \left(\xi \mapsto \frac{\sqrt{-\lambda + |\xi|^2 + 1}}{P(\lambda, |\xi|)} \right) \star u_0(x) e^{-\lambda t} d\lambda.$$

It directly proves the existence of $\tilde{x}_1 \geq x_1$ and $\tilde{C}_1 > 0$ that only depends on u_0 such that for $|x| \geq \tilde{x}_1$ and $t > t_0$:

$$\bar{u}(x, t) \leq \tilde{C}_1 \left(e^{(f'(0) - c^2 r_0^2 \cos(2\varepsilon))t} + e^{f'(0)t} e^{-\sqrt{|x|} \sin(\varepsilon)} + \frac{e^{f'(0)t}}{|x|^3} + \frac{e^{f'(0)t}}{|x|^{1+2\alpha} t^{3/2}} + e^{(f'(0) - r_0^2)t} \right),$$

which concludes the proof of Theorem 4.3.1.

Remark 4.3.6. If the diffusion on the road is given by the standard Laplacian, we notice that inequality (4.3.31) is not sufficient to prove that the propagation is linear in time. A different study has to be conducted.

4.3.3 Proof of Theorem 4.1.2 - Part 2

Theorem 4.3.1 gives that for all $\gamma > \gamma_\star = \frac{f'(0)}{1+2\alpha}$:

$$\lim_{t \rightarrow +\infty} u(x, t) = 0 \quad \text{uniformly in } |x| \geq e^{\gamma t}.$$

This theorem also gives that the level sets move faster than $t^{-\frac{3}{2(1+2\alpha)}} e^{\frac{f'(0)}{1+2\alpha} t}$. In fact, we have proved a more precise result concerning the location of the level sets : for all $\lambda \in (0, 1/\mu)$, there exists a constant $C_\lambda > 0$ such that for t large enough

$$\{x \in \mathbb{R} \mid u(x, t) = \lambda\} \subset \left\{ x \in \mathbb{R} \mid |x| \leq C_\lambda t^{-\frac{3}{2(1+2\alpha)}} e^{\frac{f'(0)}{(1+2\alpha)t}} \right\}.$$

Thus, the speed of propagation for this two dimensional model can not be "purely exponential".

4.4 Propagation in the field : proof of Theorem 4.1.3

The proof of Theorem 4.1.3 requires an intermediate lemma for propagation in strips. It is given in [70] for Neumann boundary conditions and inhomogeneous advection. Here we need Dirichlet conditions, so we provide a proof. In the sequel, we denote by $c_{KPP} = 2\sqrt{f'(0)}$ the spreading velocity in the usual KPP equation (see [6]).

Lemma 4.4.1. *For any constant $A > \frac{\sqrt{\pi}}{c_{KPP}}$, $\tilde{A} > 0$ and $\underline{\delta} \in (0, 1)$, let \underline{f} satisfy*

$$\underline{f} \in \mathcal{C}^1([0, 1]) \text{ concave, } \underline{f} \leq f, \quad \underline{f}(0) = \underline{f}(\underline{\delta}) = 0, \text{ and } \underline{f}'(\underline{\delta}) < 0 < \underline{f}'(0) = f'(0).$$

Consider \underline{v}_1 the solution to

$$\begin{cases} \partial_s \underline{v}_1 - \Delta \underline{v}_1 = \underline{f}(\underline{v}_1), & |x| \leq A, y \in \mathbb{R}, s > 0, \\ \underline{v}_1(\pm A, y, s) = 0, & y \in \mathbb{R}, s > 0, \\ \underline{v}_1(x, y, 0) = \underline{\delta} \mathbf{1}_{|x| \leq A, y \in [0, \tilde{A}]}. \end{cases} \quad (4.4.1)$$

Set $c_{KPP}^A = 2\sqrt{f'(0) - \frac{\pi}{4A^2}}$. For all $c \in (0, c_{KPP}^A)$ and all $A_1 \in (0, A)$, we have

$$\lim_{s \rightarrow +\infty} \inf_{|x| \leq A_1, |y| \leq cs} \underline{v}_1(x, y, s) > 0.$$

Proof : We look for solutions of the form $\underline{v}_1(x, y, s) = \Phi(x, y - cs)$, where Φ is a compactly supported subsolution to the elliptic problem

$$\begin{cases} -\Delta \tilde{\Phi} - c\partial_y \tilde{\Phi} = \underline{f}(\tilde{\Phi}), & |x| \leq A, y \in \mathbb{R}, \\ \tilde{\Phi}(\pm A, y) = 0, & y \in \mathbb{R}. \end{cases} \quad (4.4.2)$$

For any constant $A > \frac{\sqrt{\pi}}{c_{KPP}}$, we define

$$c_{KPP}^A = 2\sqrt{f'(0) - \frac{\pi}{4A^2}} < c_{KPP}.$$

For $c \in (0, c_{KPP}^A)$ and $\delta \in (0, \frac{(c_{KPP}^A)^2 - c^2}{4})$, we set

$$\lambda_A = -\frac{c}{2} + i\sqrt{f'(0) - \delta - \frac{\pi^2}{4A^2} - \frac{c^2}{4}},$$

so that

$$\lambda_A \in \mathbb{C} \setminus \mathbb{R} \quad \text{and} \quad \lambda_A^2 + c\lambda_A + f'(0) - \delta = \frac{\pi^2}{4A^2}.$$

Notice that with this choice for δ , we have $f'(0) - \delta > 0$. To get an explicit expression of Φ as a subsolution to (4.4.2), we consider

$$\begin{cases} -\Delta \Phi - c\partial_y \Phi = (f'(0) - \delta)\Phi, & |x| \leq A, y \in \mathbb{R}, \\ \Phi(\pm A, y) = 0, & y \in \mathbb{R}. \end{cases} \quad (4.4.3)$$

For any constant $c_\Phi > 0$, the function

$$\Phi(x, y) = c_\Phi e^{\Re(\lambda_A)y} \sin(\Im(\lambda_A)y) \sin\left(\frac{\pi}{2A}(x + A)\right)$$

is a solution to (4.4.3) that satisfies

$$\text{for } (x, y) \in (-A, A) \times \left(0, \frac{\pi}{\Im(\lambda_A)}\right), \quad \Phi(x, y) > 0.$$

Since \underline{f} is of class $\mathcal{C}^1([0, 1])$, there exists $\eta > 0$ such that

$$\text{for all } s \in (0, \eta), \quad (f'(0) - \delta)s \leq \underline{f}(s).$$

Taking $c_\Phi \in (0, \min(\eta, \underline{\delta}))$, we have

$$\Phi(x, y) \leq \min(\eta, \underline{\delta}) \quad \text{in } (-A, A) \times \left(0, \frac{\pi}{\Im(\lambda_A)}\right),$$

which implies

$$-\Delta\Phi - c\partial_y\Phi \leq f(\Phi), \quad \text{if } |x| \leq A \text{ and } y \in \left(0, \frac{\pi}{\Im(\lambda_A)}\right).$$

Let us consider w the solution to

$$\begin{cases} \partial_s w - \Delta w - c\partial_y w = \underline{f}(w), & |x| \leq A, y \in \mathbb{R}, s > 0, \\ w(\pm A, y, s) = 0, & y \in \mathbb{R}, s > 0, \end{cases} \quad (4.4.4)$$

with initial condition

$$w(\cdot, \cdot, 0) = \begin{cases} \Phi & \text{in } (-A, A) \times \left(0, \frac{\pi}{\Im(\lambda_A)}\right), \\ 0 & \text{otherwise.} \end{cases}$$

Applying the maximum principle in $(-A, A) \times \left(0, \frac{\pi}{\Im(\lambda_A)}\right)$, with Dirichlet conditions, we have

$$\text{for all } s \geq 0 \text{ and } (x, y) \in (-A, A) \times \left(0, \frac{\pi}{\Im(\lambda_A)}\right), \quad w(x, y, s) \geq \Phi(x, y).$$

Then, since $w(\cdot, \cdot, 0)$ is a subsolution to (4.4.4), the function w is nondecreasing in the s -variable. The function identically equal to $\underline{\delta}$ is a supersolution to (4.4.4), which implies that w is bounded in $(-A, A) \times \mathbb{R} \times \mathbb{R}_+$. Thus, there exists a limiting function $w_\infty(x, y)$ to which $w(x, y, s)$ converges as s goes to $+\infty$. Using classical parabolic estimates and Ascoli's theorem, we get the uniform convergence on every compact subset of $(-A, A) \times \mathbb{R}$, as well as for the derivatives $\partial_y w$, $\partial_s w$ and Δw . This leads to

$$-\Delta w_\infty - c\partial_y w_\infty = \underline{f}(w_\infty) \quad \text{in } (-A, A) \times \mathbb{R}, \quad (4.4.5)$$

with Dirichlet boundary conditions. Since $s \mapsto w(\cdot, \cdot, s)$ is nondecreasing and starts from a function that is non identically equal to zero, we have $w_\infty \not\equiv 0$. More precisely, the strong maximum principle applied to problem (4.4.5), with Dirichlet boundary conditions, gives

$$\text{for all } A_1 \in (0, A), \quad w_\infty > 0 \quad \text{in} \quad (-A_1, A_1) \times \mathbb{R}. \quad (4.4.6)$$

We go back to the function \underline{v}_1 . There exists $c_\Phi \in (0, \min(\delta, \eta))$ such that

$$\underline{v}_1(\cdot, \cdot, 0) \geq w(\cdot, \cdot, 0),$$

and, with the maximum principle to (4.4.4), we have for all $s \geq 0$

$$\underline{v}_1(\cdot, \cdot + cs, s) \geq w(\cdot, \cdot, s), \quad \text{in } (-A, A) \times \mathbb{R}.$$

Passing to the limit as s tends to $+\infty$ and using 4.4.6, we get

$$\text{for all } A_1 \in (0, A), \quad \lim_{s \rightarrow +\infty} \underline{v}_1(x, y + cs, s) > 0, \quad \text{uniformly in } (x, y) \in (-A_1, A_1) \times \mathbb{R}.$$

■

Proof of Theorem 4.1.3 : Let (v, u) be the solution to (4.1.1) with $(0, u_0)$ as initial condition, where u_0 is a compactly supported function. Let us define $\bar{u} = \max\left(\frac{1}{\mu}, \|u_0\|_\infty\right)$ and \bar{v} the solution to

$$\begin{cases} \partial_t \bar{v} - \partial_{yy} \bar{v} = f(\bar{v}), & y > 0, t > 0, \\ -\partial_y \bar{v}|_{y=0} = \mu \bar{u} - \bar{v}|_{y=0}, & t > 0. \end{cases} \quad (4.4.7)$$

with the initial condition $\bar{v}(\cdot, 0) = \mathbb{1}_{[0,1]}$. The couple (\bar{v}, \bar{u}) is a supersolution to (4.1.1), with nonnegative initial condition, and Remark 3.4.6 gives that (v, u) is below (\bar{v}, \bar{u}) at any time. Since $f(s) < 0$ for $s > 1$, the maximum principle applied to the system (4.4.7), gives for all $t \geq 0$:

$$\bar{v}(0, t) \leq \mu \bar{u}.$$

Thus, at every time, the solution \bar{v} to (4.4.7) is below the solution \bar{v}_1 to

$$\partial_t \bar{v}_1 - \partial_{yy} \bar{v}_1 = f(\bar{v}_1), \quad y \in \mathbb{R}, t > 0,$$

starting from $\bar{v}_1(\cdot, 0) = \bar{v}(\cdot, 0)$. Thus we have

$$\text{for all } (x, y) \in \mathbb{R} \times \mathbb{R}_+, \text{ and all } t \geq 0, \quad v(x, y, t) \leq \bar{v}(y, t) \leq \bar{v}_1(y, t).$$

Finally, from Aronson and Weinberger in [5], we get :

$$\text{for all } c > c_{KPP}, \quad \lim_{t \rightarrow +\infty} \sup_{|y| \geq ct} \bar{v}_1(y, t) = 0.$$

This ends the proof of the first point of Theorem 4.1.3.

The second point of Theorem 4.1.3 is just a matter of counting how many intervals of length ct fit into $[-e^{\varepsilon t}, e^{\varepsilon t}]$. Set $\theta \in (0, \frac{\pi}{2}]$ and $c \in \left(0, \frac{c_{KPP}}{\sin(\theta)}\right)$. We want to prove the existence of a constant $\delta > 0$ and a time $t_0 > 0$ such that for $t \geq t_0$ and $|r| \leq ct$:

$$v(r \cos(\theta), |r| \sin(\theta), t) \geq \delta.$$

In fact we prove a stronger result that is the existence of a constant $\varepsilon > 0$ such that, for all $t \geq t_0$, the following two points are satisfied :

- $v(\cdot, \cdot, t) \geq \delta$ in the strip $[-e^{\varepsilon t}, e^{\varepsilon t}] \times [0, c \sin(\theta)t]$,
- $\tan(\theta) \geq cte^{-\varepsilon t}$: this ensures that for all $|r| \leq ct$: $(r \cos(\theta), |r| \sin(\theta)) \in [-e^{\varepsilon t}, e^{\varepsilon t}] \times [0, c \sin(\theta)t]$. This point is illustrated by the following picture.

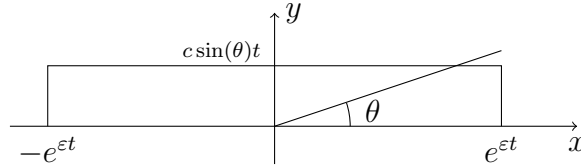

More precisely, we prove the existence of constants $\varepsilon > 0$ and $l > 0$ such that, for a finite number of intervals I_l of length l covering $[-e^{\varepsilon t}, e^{\varepsilon t}]$, we have

$$\tan(\theta) \geq cte^{-\varepsilon t} \quad \text{and} \quad v(\cdot, \cdot, t) \geq \delta \quad \text{in} \quad I_l \times [0, c \sin(\theta)t]. \quad (4.4.8)$$

From Lemma 4.4.1, we can choose $l > 0$ and $\varepsilon > 0$ such that

$$c \sin(\theta) < c_{KPP}^l (1 - \varepsilon) < c_{KPP}^l < c_{KPP},$$

where c_{KPP}^l is the speed defined in Lemma 4.4.1. Let I_l be an interval of length l included in $[-e^{\varepsilon t}, e^{\varepsilon t}]$. From the same lemma, we get the existence of a constant $\delta > 0$ and a time $s_l > 0$ such that the solution \underline{v}_2 to (4.4.1), defined for $\tilde{A} = \frac{L}{2} \left(1 - \frac{h}{\pi}\right)$ and $A = \frac{l}{2}$, satisfies

$$\text{for } s \geq s_l, |x| \in I_l \text{ and } y \in \left[0, \frac{c \sin(\theta)}{1 - \varepsilon} s\right] : \quad \underline{v}_2(x, y, s) \geq \delta. \quad (4.4.9)$$

Let us define

$$t_0 \geq \max \left(\frac{s_l}{1 - \varepsilon}, \varepsilon^{-1} \right) \quad \text{such that} \quad \frac{e^{\varepsilon t_0}}{ct_0} > \tan(\theta)^{-1}. \quad (4.4.10)$$

For all $t \geq t_0$, due to Lemma 4.2.3 and estimate (4.2.29), we know there exist positive constants L, h, ε_0 and $\underline{\delta}$ such that for $x \in I_l$ and $y \in \left[0, \frac{l}{2} \left(1 - \frac{h}{\pi}\right)\right]$:

$$v(x, y, \varepsilon t) \geq \varepsilon_0 \underline{v}(x, y, \varepsilon t) \geq \underline{\delta}.$$

We define

$$\underline{v}_1(x, y, 0) = \underline{\delta} \mathbb{1}_{x \in I_l, y \in [0, \bar{A}]}$$

Let us fix $a_l \in [-e^{\varepsilon t}, e^{\varepsilon t} - l]$ and consider the following system

$$\begin{cases} \partial_s v - \Delta v = \underline{f}(v), & x \in I_l, y > 0, s > 0, \\ v(a_l, y, s) = v(a_l + l, y, s) = 0, & y > 0, s > 0, \\ v(x, 0, s) = \underline{\delta}, & x \in I_l, s > 0, \\ v(\cdot, \cdot, 0) = \underline{v}_1(\cdot, \cdot, 0), \end{cases} \quad (4.4.11)$$

where $I_l = [a_l, a_l + l]$ and, as in Lemma 4.4.1, \underline{f} satisfies

$$\underline{f} \in C^1([0, 1]) \text{ is concave, } \underline{f} \leq f, \quad \underline{f}(0) = \underline{f}(\underline{\delta}) = 0 \text{ and } \underline{f}'(\underline{\delta}) < 0 < \underline{f}'(0) = f'(0).$$

Let us call \underline{v}_1 the solution to (4.4.11). The maximum principle applied to this system gives

$$\text{for all } s \geq 0 : v(\cdot, \cdot, s + \varepsilon t) \geq \underline{v}_1(\cdot, \cdot, s) \quad \text{in } I_l \times \mathbb{R}_+. \quad (4.4.12)$$

We now consider the problem (4.4.11) in the whole strip $I_l \times \mathbb{R}$. Due to the definition of \underline{f} and the comparison principle, the solution \underline{v}_2 to

$$\begin{cases} \partial_s \underline{v}_2 - \Delta \underline{v}_2 = \underline{f}(\underline{v}_2), & x \in I_l, y \in \mathbb{R}, s > 0, \\ \underline{v}_2(a_l, y, s) = \underline{v}_2(a_l + l, y, s) = 0, & y \in \mathbb{R}, s > 0, \\ \underline{v}_2(\cdot, \cdot, 0) = \underline{v}_1(\cdot, \cdot, 0), \end{cases} \quad (4.4.13)$$

starting from $\underline{v}_1(\cdot, \cdot, 0)$, remains bounded by $\underline{\delta}$ at any time. In particular, \underline{v}_2 is smaller than $\underline{\delta}$ on the line $\{y = 0\}$ and we have

$$\text{for } (x, y) \in I_l \times \mathbb{R}_+ \text{ and } t \geq 0, \quad \underline{v}_2(x, y, t) \leq \underline{v}_1(x, y, t). \quad (4.4.14)$$

Combining (4.4.12) and (4.4.14), it is sufficient to understand the behaviour of \underline{v}_2 to get the expected result on v . Using (4.4.9), we have for $s \geq s_l$, $x \in I_l$ and $y \in \left[0, \frac{c \sin(\theta)}{1 - \varepsilon} s\right]$:

$$v(x, y, s + \varepsilon t) \geq \underline{v}_2(x, y, s) \geq \delta.$$

Finally, taking $s = (1 - \varepsilon)t \geq (1 - \varepsilon)t_0 \geq s_l$, we have

$$\text{for } t \geq t_1, \text{ and } (x, y) \in I_l \times [0, c \sin(\theta)t], \quad v(x, y, t) \geq \delta.$$

This is true for all intervals $I_l \subset [-e^{\varepsilon t}, e^{\varepsilon t}]$, which concludes the proof. \blacksquare

Chapter 5

Numerical simulations

5.1 Introduction

This chapter is devoted to numerical simulations concerning the model studied in [18, 17, 19] (for $\alpha = 1$) and in the two previous chapters (for $D = 1$) :

$$\begin{cases} \partial_t v - \Delta v = v - v^2, & x \in \mathbb{R}, y > 0, t > 0, \\ \partial_t u + D(-\partial_{xx})^\alpha u = -u + v|_{y=0}, & x \in \mathbb{R}, y = 0, t > 0, \\ -\partial_y v|_{y=0} = u - v|_{y=0}, & x \in \mathbb{R}, y = 0, t > 0, \end{cases} \quad (5.1.1)$$

for a constant $D \geq 1$, completed with initial conditions $v(\cdot, \cdot, 0) = 0$ and $u_0(x) = \mathbb{1}_{\{|x| \leq 1\}}$.

The goals are the following. We not only want to illustrate known results in both cases $\alpha = 1$ and $\alpha \in (0, 1)$, but also investigate qualitative properties (like the monotonicity of the density v and the role of the term $-u + v|_{y=0}$), and a precise asymptotic expression of the location of the level sets in the fractional case.

It is organised as follows. Section 5.2 is devoted to the numerical procedure used to solve problem (5.1.1). In section 5.3, in addition to illustrating the results proved in [18], [17] and [19] in the case $\alpha = 1$ and $D > 1$, which is a good indication of the validity of the algorithm set up, we study the signs of $\partial_y v|_{y=0}$ and $-u + v|_{y=0}$. Section 5.4 concern an illustration of Theorems 4.1.2 and 4.1.3, that treat problem (5.1.1) with $\alpha \in (0, 1)$ and $D = 1$, and section 5.5 investigate a more precise expression of the asymptotic location of the level sets.

5.2 Numerical procedure

The numerical computation of the solution to (5.1.1), described in this section, is valid for any $\alpha \in (0, 1]$. We treat separately the three equations of the system. We begin with the description of the second equation of (5.1.1), that concerns the density u on the road. Then, we turn to the first equation of (5.1.1) that gives the evolution of the

density v in the field. Finally, the third equation of (5.1.1) is considered as a Robin boundary condition of the first equation of (5.1.1).

- The second equation of (5.1.1) is treated as in section 1.7, dealing with Strang splitting and Fourier transform in the x variable. This technique is valid for all $\alpha \in (0, 1]$. Let us recall the main steps. If T^t denotes the semi flow associated with (5.1.1), a natural approach to estimate $T^t u_0$ is to split the diffusive term and the reaction term as follows. Let t_0 be any nonnegative constant and $u_{t_0} : \mathbb{R} \rightarrow \mathbb{R}$ any function, non identically equal to 0, that decays faster than the fundamental solution p_α of the operator $(-\Delta)^\alpha$.

1. The first step of the splitting treats the diffusive part of (5.1.1), which is

$$\begin{cases} \partial_t u + D(-\partial_{xx})^\alpha u = 0, & \mathbb{R}, t > t_0, \\ u(x, t_0) = u_{t_0}(x), & x \in \mathbb{R}. \end{cases} \quad (5.2.1)$$

The solution to (5.2.1), denoted by $X^t u_{t_0}$, is explicitly given, for $x \in \mathbb{R}$ and $t > t_0$, by

$$X^t u_{t_0}(x, t) = \mathcal{F}^{-1} \left(\xi \mapsto e^{-D|\xi|^{2\alpha}(t-t_0)} \mathcal{F}(u_{t_0})(\xi) \right) (x),$$

where \mathcal{F} and \mathcal{F}^{-1} are respectively the Fourier transform and the inverse Fourier transform in the space variable.

Remark 5.2.1. The solution $X^t u_{t_0}$ is computed with Fast Fourier Transform techniques that require a small step size of discretisation in the x -variable.

2. The reaction term of (5.1.1) appears in the second step of the splitting, and is given by the ordinary differential equation :

$$\begin{cases} \partial_t u = -u + v|_{y=0}, & \mathbb{R}, t > 0, \\ u(x, t_0) = u_{t_0}(x), & x \in \mathbb{R}. \end{cases} \quad (5.2.2)$$

The solution, denoted by $Y^t u_{t_0}$, has the explicit expression

$$Y^t u_{t_0}(x, t) = e^{-(t-t_0)} u_{t_0}(x) + \int_{t_0}^t e^{-(t-s)} v(x, 0, s) ds.$$

We use the explicit Euler method to solve (5.2.2) on $[-X_{max}, X_{max}] \times [t_0, t_0 + T]$, for any $X_{max} > 0$, and any $T > 0$. Given $N \in \mathbb{N}^*$ and $J \in \mathbb{N}^*$ large enough, this method consists in constructing, for $n \in \llbracket 0, N \rrbracket$ and $j \in \llbracket 0, J \rrbracket$, a sequence u_j^n , which is supposed, as usual, to approximate $u(x_j, t_n)$, with $dx = 2\frac{X_{max}}{J}$, $x_j = -X_{max} + jdx$, $dt = \frac{T}{N}$ and $t_n = ndt$. The sequence u_j^n is defined by

$$u_j^0 = u_{t_0}(x_j),$$

and for all $n \in \llbracket 0, N - 1 \rrbracket$ and all $j \in \llbracket 0, J \rrbracket$:

$$u_j^{n+1} = u_j^n + dt e^{-dt} (u_j^n + v(x_j, 0, t_n)).$$

As explained in section 1.7, the two Strang approximation formulas are, for $t \geq t_0$

$$S_1^{t-t_0} u_{t_0} = X^{\frac{t-t_0}{2}} Y^{t-t_0} X^{\frac{t-t_0}{2}} u_{t_0}, \quad S_2^{t-t_0} u_{t_0} = Y^{\frac{t-t_0}{2}} X^{t-t_0} Y^{\frac{t-t_0}{2}} u_{t_0}. \quad (5.2.3)$$

In our case, numerical results show that both approximations S_1 and S_2 lead to the same results.

Remark 5.2.2. We could have split the second equation of (5.1.1) considering the following problems :

$$\begin{cases} \partial_t u + D(-\partial_{xx})^\alpha u = -u, & \mathbb{R}, t > t_0, \\ u(x, t_0) = u_{t_0}(x), & x \in \mathbb{R}, \end{cases}$$

and

$$\begin{cases} \partial_t u = v|_{y=0}, & \mathbb{R}, t > 0, \\ u(x, t_0) = u_{t_0}(x), & x \in \mathbb{R}. \end{cases}$$

This leads to similar results to those obtained with the splitting (5.2.1) and (5.2.2).

- The first equation of (5.1.1) is treated with a finite difference scheme. We keep in mind that, as explained in Remark 5.2.1, a small step size of discretisation in the x -variable is needed in the numerical solvability of the second equation of (5.1.1). Thus, for any $X_{max} > 0$, $Y_{max} > 0$, $T > 0$, we solve the first equation of (5.1.1) on $[-X_{max}, X_{max}] \times [0, Y_{max}] \times [t_0, t_0 + T]$, using the explicit Euler method in the y -variable, and the backward Euler method in the x -variable. We impose Neumann boundary conditions except on the road $[-X_{max}, X_{max}] \times \{0\}$, where the boundary condition is given by the third equation of (5.1.1).

Let us describe the method in more detail. Given $N \in \mathbb{N}^*$, $J \in \mathbb{N}^*$ and $K \in \mathbb{N}^*$ large enough, it consists in constructing, for $n \in \llbracket 0, N \rrbracket$, $j \in \llbracket 0, J \rrbracket$, and $k \in \llbracket 0, K \rrbracket$, a sequence $v_{j,k}^n$ supposed to approximate $v(-X_{max} + jdx, kdy, ndt)$, with $dx = 2\frac{X_{max}}{J}$, $dy = \frac{Y_{max}}{K}$ and $dt = \frac{T}{N}$. The sequence $v_{j,k}^n$ is defined by the following scheme :

1. Initial condition : for all $j \in \llbracket 0, J \rrbracket$ and $k \in \llbracket 0, K \rrbracket$:

$$v_{j,k}^0 = 0,$$

2. Euler scheme : for all $n \in \llbracket 0, N - 1 \rrbracket$, $j \in \llbracket 1, J - 1 \rrbracket$ and $k \in \llbracket 1, K - 1 \rrbracket$:

$$\frac{v_{j,k}^{n+1} - v_{j,k}^n}{dt} - \frac{v_{j+1,k}^{n+1} - 2v_{j,k}^{n+1} + v_{j-1,k}^{n+1}}{dx^2} - \frac{v_{j,k+1}^n - 2v_{j,k}^n + v_{j,k-1}^n}{dy^2} = v_{j,k}^n - v_{j,k}^{n-2}$$

3. Neumann boundary conditions : for all $n \in \llbracket 0, N-1 \rrbracket$, $j \in \llbracket 1, J-1 \rrbracket$ and $k \in \llbracket 1, K-1 \rrbracket$:

$$v_{0,k}^{n+1} = v_{1,k}^{n+1}, \quad v_{J,k}^{n+1} = v_{J-1,k}^{n+1}, \quad v_{j,K}^{n+1} = v_{j,K-1}^{n+1}.$$

The boundary condition on $[-X_{max}, X_{max}] \times \{0\}$, which corresponds to the value of $v_{j,0}^{n+1}$, is given by the third equation of (5.1.1).

- The third equation of (5.1.1), that concerns exchanges between the field and the road, is treated with a finite difference method. Using the same notations as previously, we consider that for all $j \in \llbracket 0, J \rrbracket$ and all $n \in \llbracket 0, N \rrbracket$, u_j^n is an approximation of $u(-X_{max} + jdx, ndt)$. Thus, the boundary condition on $[-X_{max}, X_{max}] \times \{0\}$ is given, for all $n \in \llbracket 0, N-1 \rrbracket$ and $j \in \llbracket 0, J \rrbracket$, by :

$$-\frac{v_{j,1}^{n+1} - v_{j,0}^{n+1}}{dy} = u_j^{n+1} - v_{j,0}^{n+1},$$

which means

$$v_{j,0}^{n+1} = \frac{v_{j,1}^{n+1} + dy u_j^{n+1}}{1 + dy}.$$

In the sequel, the stopping criterion is imposed by a time from which the expected speed of propagation is reached, in both cases $\alpha = 1$ and $\alpha \in (0, 1)$. The step sizes of discretisation in the x -, y - and t - variables are chosen so that the Courant - Friedrichs - Lewy (CFL) conditions are satisfied.

5.3 Standard diffusion on the road ($\alpha = 1$) : level sets in the field

We first want to illustrate the theorems, recalled in the general introduction of the thesis and proved in [18, 17, 19], that concern the following Cauchy problem

$$\begin{cases} \partial_t v - \Delta v = v - v^2, & x \in \mathbb{R}, y > 0, t > 0, \\ \partial_t u - D \partial_{xx} u = -u + v|_{y=0}, & x \in \mathbb{R}, y = 0, t > 0, \\ -\partial_y v|_{y=0} = u - v|_{y=0}, & x \in \mathbb{R}, y = 0, t > 0, \end{cases} \quad (5.3.1)$$

for a constant $D > 2$, starting from the initial conditions $v(\cdot, \cdot, 0) = 0$ and $u(\cdot, 0) = \mathbb{1}_{\{|\cdot| \leq 1\}}$. Such a diffusion coefficient on the road enhances global diffusion in the half plane, and the propagation is driven by the diffusion on the line $\{(x, 0), x \in \mathbb{R}\}$. The different speeds of propagation, on the road and in the direction normal to the road, solve algebraic equations, given in (5.3) of [18]. It is of particular interest to know the speed of propagation in any direction of the field. In other words, we want to

illustrate the shape of the level sets of the solution (v, u) to (5.3.1) in the field, which is rigorously given in [19].

In our numerical computations, we fix $D = 10$, $X_{max} = 200$ and $Y_{max} = 100$, which means that we work in the domain $[-200, 200] \times [0, 100]$. In this case, the results of [18] gives a speed on the road close to 3,32, whereas the speed in the direction normal to the road is $c_{KPP} = 2$.

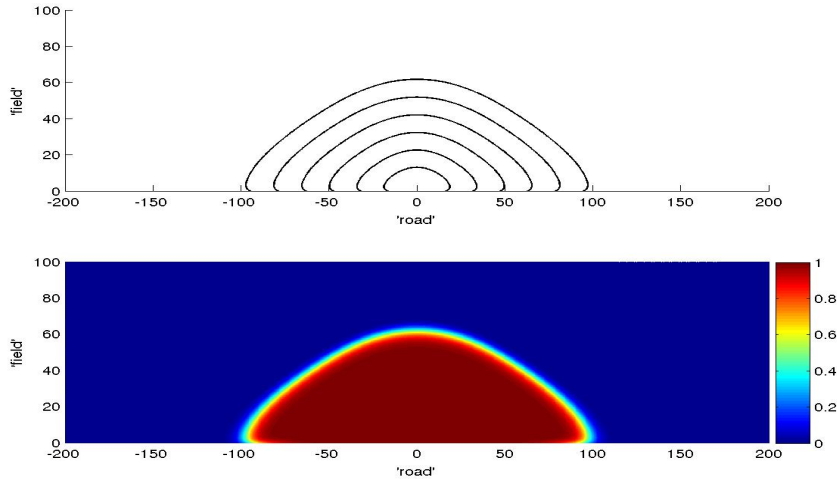

Figure 5.1: Results for $\alpha = 1$ and $D = 10$ in (5.3.1): the shape of the level sets of value 0, 5 of v , solution to (5.3.1), at successive times $t = 10, 15, \dots, 35$ (at the top), and the density v at time $t = 35$ (at the bottom).

Figure 5.1 gives the shape of the level sets of value 0, 5 of v , solution to (5.3.1) at successive times $t = 10, 15, \dots, 35$, and the display of the density v in the field at time $t = 35$. The level sets displayed on this figure are even and decreasing in $|x|$ functions $g_n : \mathbb{R} \rightarrow \mathbb{R}$, satisfying, for all $x \in \mathbb{R}$ and for all $n \in \llbracket 1, 7 \rrbracket$,

$$u(x, g_n(x), t_n) = \frac{1}{2},$$

where $t_n = 5n$, for $n \in \llbracket 1, 7 \rrbracket$.

Using the values given by Figure 5.1, we can check that the speed of propagation in the direction normal to the road corresponds to the standard KPP velocity. Indeed, for $n \in \llbracket 1, 6 \rrbracket$, the quantity $g_{n+1}(0) - g_n(0)$, corresponding to the expected speed of propagation multiplied by the time elapsed between two successive level sets, is equal to $2 \times 5 = 10$, which is the value we obtain when analysing Figure 5.1.

Let us now interpret Figure 5.1. It reveals that the level sets seem to be circular in a sector whose axis is normal to the road. The shape of the level sets we obtained corresponds to the set \mathcal{W} proved in [19], where the authors explain that the road enhances the asymptotic speed of propagation in every direction of the field, up to a

critical angle. The shape of the level sets of v is almost similar to the one described in Theorem 1.1 of [19]. There is, however, a particular phenomenon in a neighbourhood of the road. Indeed, for $y \in [0, Y_D(t)]$ where Y_D is a function that may depend on time and the diffusion coefficient D , $\partial_y v$ seems to be positive. At first sight, this is surprising, even though not incompatible with [19]. Indeed, the expansion set studied in [19] is an asymptotic figure, up to $o(t)$ perturbations. From the results proved in [19], we should have $Y_D(t) = o(t)$, as t goes to $+\infty$.

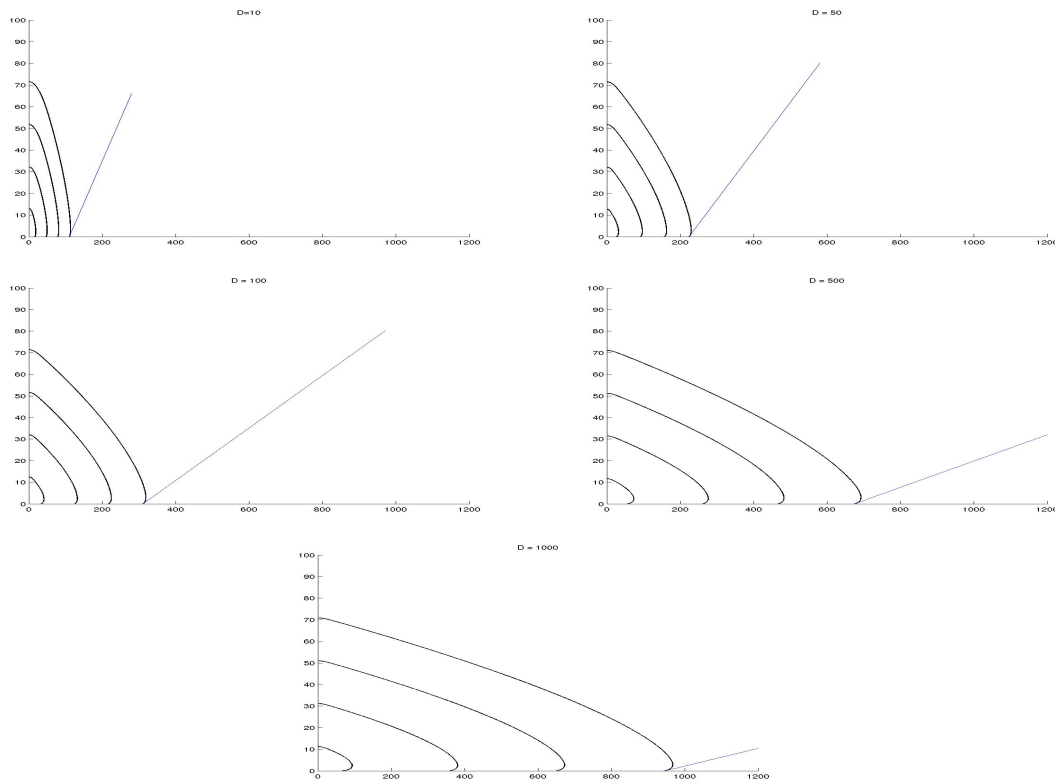

Figure 5.2: Level sets of value 0,5 of v at successive times $t=10,20,30,40$ and the tangent line to the level set at $y = 0$ and at time $t = 40$ for the different values of D : $D = 10, D = 50, D = 100, D = 500$ and $D = 1000$ (from left to right and up and down). The x axis and y axis do not have the same scale.

Figure 5.2 shows the tangent lines to the level set of value 0,5 of v , at $y = 0$ and $t = 40$, for the different values of D : $D = 10, D = 50, D = 100, D = 500$ and $D = 1000$. For the sake of readability, the x axis and y axis do not have the same scale. The angle between the tangent and the normal to the road is equal to $68,8^\circ$ for $D = 10$, $77,4^\circ$ for $D = 50$, $83,1^\circ$ for $D = 100$, $86,6^\circ$ for $D = 500$ and $87,7^\circ$ for $D = 1000$. This reveals that the slope of the tangent lines to the level sets of the density in the field, at points touching the road, seems to decrease as D tends to infinity.

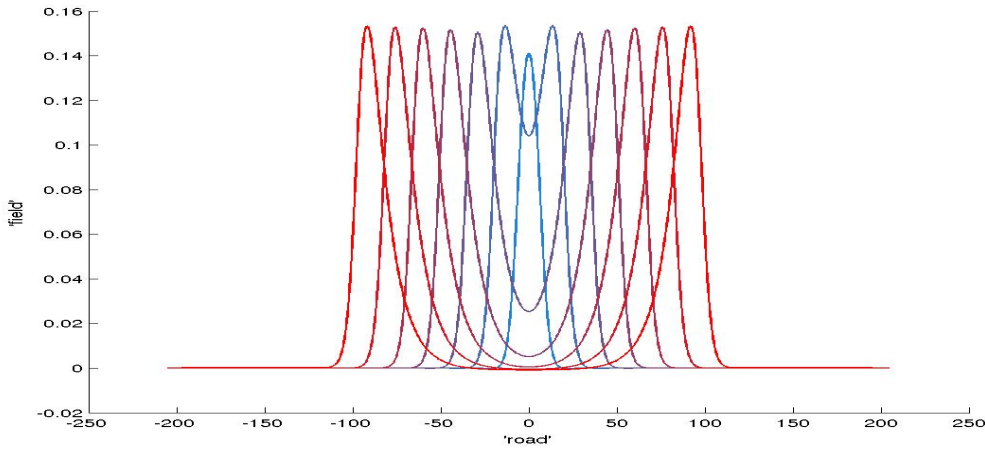

Figure 5.3: Display of $-u + v|_{y=0}$ for (v, u) solution to (5.3.1) with $\alpha = 1$ and $D = 10$, at successive times $t = 5, 15, \dots, 35$, with a colour graduation from blue to red.

It turns out that this is related to the fact that there is no reaction on the road in (5.3.1). In fact, the term $-u + v|_{y=0}$ may be thought of as a nonnegative reaction term for the second equation, as shown by Figure 5.3. This is only a heuristic explanation of the fact that propagation is actually driven by the road. Notice the analogy with a positive reaction term, as, for instance, flame propagation theory (see [15, 84]). Also note the dissymmetry of the level sets of $-u + v|_{y=0}$. Thus, the third equation of (5.3.1) gives $\partial_y v(x, 0, t) \geq 0$, for all $x \in \mathbb{R}$ and $t > 0$.

To confirm the hypothesis that $-u + v|_{y=0}$ acts as a source term, we allow reproduction on the road and we take the same rate as in the field :

$$\begin{cases} \partial_t v - \Delta v = v - v^2, & x \in \mathbb{R}, y > 0, t > 0, \\ \partial_t u + D(-\partial_{xx})u = -u + v|_{y=0} + (u - u^2), & x \in \mathbb{R}, y = 0, t > 0, \\ -\partial_y v|_{y=0} = u - v|_{y=0}, & x \in \mathbb{R}, y = 0, t > 0. \end{cases} \quad (5.3.2)$$

We see, on Figure 5.4 that the exchange term is damped by that of the source term added on the road.

Figure 5.4 shows that the shape of the level sets of v , solution to (5.3.2) is exactly the one described in [19]. Figure 5.5 highlights the cone, around the normal to the road, outside which the speed of propagation is enhanced by the road. This figure also underlines the effect of a reaction term on the road, on the tangent lines to the level set of v at $y = 0$ and $t = 35$.

The good quantitative agreement between the results of [18, 17, 19], and the numerical simulations is an indication of the validity of the numerical procedure.

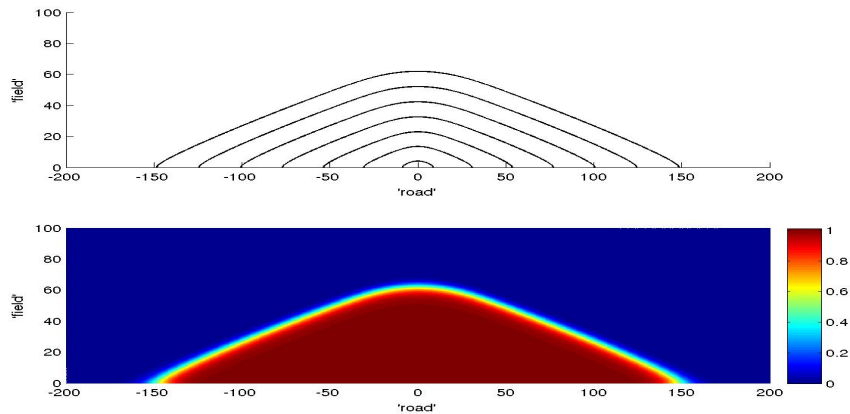

Figure 5.4: Results for $\alpha = 1$ and $D = 10$ in (5.3.2): the shape of the level sets of value 0, 5 of the density v , solution to (5.3.2), at successive times $t = 10, 15, \dots, 35$ (at the top), and the density v at time $t = 35$ (at the bottom).

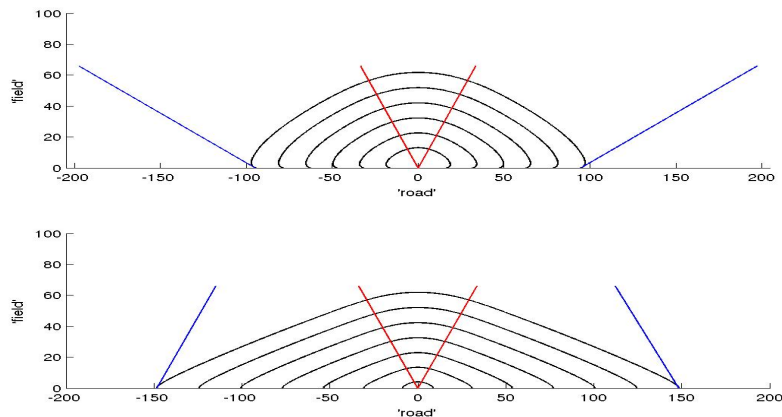

Figure 5.5: Level sets of value 0, 5, at successive times $t = 10, 15, \dots, 35$, of the density v solution to (5.3.1) at the top, and to (5.3.2) at the bottom. In red : the critical cone in which the level sets are spherical, in blue : the tangent lines of the level set at $y = 0$ and at time $t = 35$.

5.4 Fractional diffusion on the road ($\alpha \in (0, 1)$) : level sets in the field

In this section, we focus on the following Cauchy problem

$$\begin{cases} \partial_t v - \Delta v = v - v^2, & x \in \mathbb{R}, y > 0, t > 0, \\ \partial_t u + (-\partial_{xx})^\alpha u = -u + v|_{y=0}, & x \in \mathbb{R}, y = 0, t > 0, \\ -\partial_y v|_{y=0} = u - v|_{y=0}, & x \in \mathbb{R}, y = 0, t > 0, \end{cases} \quad (5.4.1)$$

for $\alpha \in (0, 1)$, starting from the initial conditions $v(\cdot, \cdot, 0) = 0$ and $u(\cdot, 0) = \mathbb{1}_{\{|x| \leq 1\}}$ to illustrate Theorems 4.1.2 and 4.1.3.

In our numerical computations, we fix $\alpha = 0,5$, $X_{max} = 200$ and $Y_{max} = 100$, which means that we work in the domain $[-200, 200] \times [0, 100]$. From Theorem 4.1.2, the speed of propagation is expected to be exponential in time, with an exponent equal to $\frac{1}{1+2\alpha} = \frac{1}{2}$.

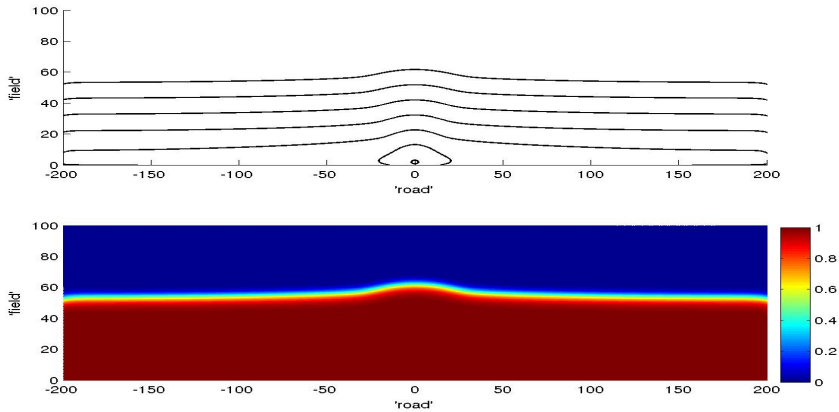

Figure 5.6: Results for $\alpha = 0,5$. Shape of the level sets of value 0,5 of the density v , solution to (5.4.1), at successive times $t = 10, 15, \dots, 35$ (at the top), and display of v at time $t = 35$ (at the bottom).

Figure 5.6 gives the shape of the level sets of value 0,5 of v , solution to (5.4.1), at successive times $t = 5, 10, \dots, 35$. The level sets displayed on this figure are even and decreasing in $|x|$ functions $g_n : \mathbb{R} \rightarrow \mathbb{R}$, satisfying, for all $x \in \mathbb{R}$ and for all $n \in \llbracket 1, 7 \rrbracket$,

$$u(x, g_n(x), t_n) = \frac{1}{2},$$

where $t_n = 5n$, for $n \in \llbracket 1, 7 \rrbracket$.

Using the values given by Figure 5.6, we can check that the speed of propagation in the direction normal to the road corresponds to the standard KPP velocity. Indeed, similarly to the case $\alpha = 1$, for $n \in \llbracket 1, 6 \rrbracket$, the quantity $g_{n+1}(0) - g_n(0)$, corresponding to the expected speed of propagation multiplied by the time elapsed between two successive level sets, is equal to $2 \times 5 = 10$, which is the value we obtain when analysing Figure 5.6. Similarly, we can verify that the speed on the road is exponential in time with exponent equal to $\frac{1}{1+2\alpha}$. Indeed, if, for any $n \in \llbracket 1, 7 \rrbracket$, x_n satisfies $g_n(x_n) = 0$, then, for $n \in \llbracket 1, 6 \rrbracket$, the quotient $\frac{x_{n+1}}{x_n}$ is close to $e^{\frac{t_{n+1}-t_n}{1+2\alpha}}$, as expected.

As in the case $\alpha = 1$, it seems that, in a neighbourhood of the road, the quantity $\partial_y v$ is positive, as explained in section 5.3. Figure 5.6 also displays the density v in the field at time $t = 35$ (at the bottom). This figure illustrates the proof of Theorem 4.1.3, where we use the fact that the invasion in the field is given by known results on

Fisher-KPP type equations, in the half plane $\{(x, y), x \in \mathbb{R}, y \geq 0\}$, with the initial condition $\mathbf{1}_{\{y=0\}}$. This figure reveals that, at time $t = 35$, the level set seems not to be a straight line in the compact $[-X_{max}, X_{max}] \times [0, Y_{max}]$.

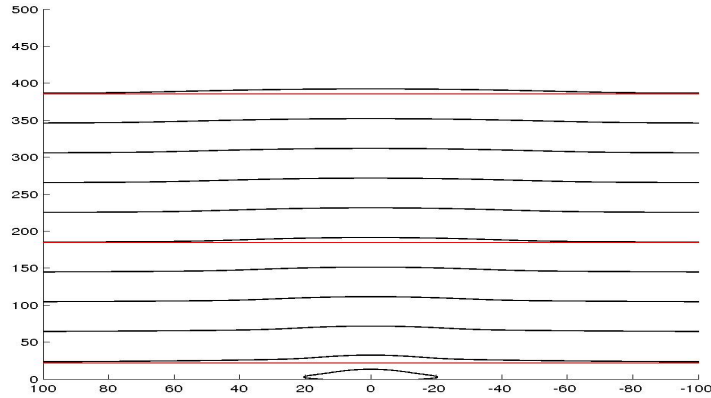

Figure 5.7: Level sets of value 0, 5 of the density v solution to (5.4.1), with $\alpha = 0, 5$, at successive times $t = 10$ and $t = 20, 40, 60, \dots, 200$ in black. The red straight lines make it easy to see the decreasing difference between the value of the level set at points $(150, y)$ and $(0, y)$, for values of y corresponding to the times $t = 20, t = 100$ and $t = 200$.

To investigate this phenomenon, we solve the same problem (5.4.1), with $\alpha = 0, 5$, but stopping the procedure at time $t = 200$ instead of $t = 35$. Figure 5.7 shows the result. We can see that, for any $y \geq 0$, the difference between the level set at point $(0, y)$ and the value of the level set at point $(150, y)$ decreases in time. Thus, this distance seems to be a small perturbation of order $o(t)$, as t goes to infinity, in the expression of the location of the level sets, which is consistent with Theorem 4.1.3. An explicit expression of this perturbation is not given in this theorem, in which we focus on propagation in sets of the form $\{|x| < ct, y \in [0, Y_{max}]\}$ with $c < c_{KPP} = 2$, and $\{|x| > ct, y \in [0, Y_{max}]\}$ with $c > c_{KPP} = 2$.

5.5 Numerical determination of the asymptotic location of the level sets, on the road, in the fractional case

The problem under study in this section is the same as in section 5.4 :

$$\begin{cases} \partial_t v - \Delta v = v - v^2, & x \in \mathbb{R}, y > 0, t > 0, \\ \partial_t u + (-\partial_{xx})^\alpha u = -u + v|_{y=0}, & x \in \mathbb{R}, y = 0, t > 0, \\ -\partial_y v|_{y=0} = u - v|_{y=0}, & x \in \mathbb{R}, y = 0, t > 0, \end{cases} \quad (5.5.1)$$

for $\alpha \in (0, 1)$, starting from the initial conditions $v(\cdot, \cdot, 0) = 0$ and $u(\cdot, 0) = \mathbf{1}_{\{|\cdot| \leq 1\}}$.

From Theorem 4.1.2, we know that the propagation on the road is exponential in time. However, this theorem does not give a sharp asymptotics of the location of the level sets. The aim of this section is to investigate numerically a more precise result. Our intuition is driven by the estimate of the solution to the linearised problem at 0 associated to (5.5.1), given in Theorem 4.3.1, and recalled here, in the case $k = 0$.

Theorem 5.5.1. *Let $\alpha \in (\frac{1}{4}, 1)$, and $r_0 > 1$ be the solution to $r_0^2 = r_0^{2\alpha} + 1$. There exist $c \in (\frac{1}{r_0}, 1)$ and a constant $\tilde{C}_1 > 0$ such that for $|x| \geq 1$, the solution u to (5.5.1) satisfies*

$$u(x, t) \leq \tilde{C}_1 \left(\frac{e^t}{|x|^{1+2\alpha} t^{3/2}} + R(x, t) \right),$$

with

$$R(x, t) \leq e^{(1-c^2 r_0^2 \cos(2\varepsilon))t} + e^t e^{-\sqrt{|x|} \sin(\varepsilon)} + \frac{e^t}{|x|^3} + e^{(1-r_0^2)t},$$

where $\varepsilon > 0$ satisfies $c^2 r_0^2 \cos(2\varepsilon) > 1$.

Thus, the dynamics of the level sets of u is given, for large values of $|x|$ and t , by $\frac{e^t}{|x|^{1+2\alpha} t^{3/2}}$. This proves rigorously that the level sets can not move faster than $t^{-\frac{3}{2(1+2\alpha)}} e^{\frac{t}{1+2\alpha}}$. This raises the following question : would, by any chance, the solution to the linearised problem at 0 related to (5.5.1) give the correct asymptotic expression of the location of the level sets?

To see this, we rescale problem (5.5.1) in the x -variable, defining the functions \tilde{v} and \tilde{u} , on $\mathbb{R} \times \mathbb{R}_+ \times \mathbb{R}_+$, by

$$\tilde{v}(\tilde{x}, y, t) = v(e^{lt} t^{-m} \tilde{x}, y, t) \quad \text{and} \quad \tilde{u}(\tilde{x}, t) = u(e^{lt} t^{-m} \tilde{x}, t),$$

where $l = \frac{1}{1+2\alpha}$, and $m \geq 0$ is the constant that we want to investigate. The couple (\tilde{v}, \tilde{u}) solves for $\tilde{x} \in \mathbb{R}$

$$\begin{cases} \partial_t \tilde{v} - (l - \frac{m}{t}) \tilde{x} \partial_{\tilde{x}} \tilde{v} - e^{-2lt} t^{2m} \partial_{\tilde{x}\tilde{x}} \tilde{v} - \partial_{yy} \tilde{v} = \tilde{v} - \tilde{v}^2, & y > 0, t > 0, \\ \partial_t \tilde{u} - (l - \frac{m}{t}) \tilde{x} \partial_{\tilde{x}} \tilde{u} + e^{-2\alpha lt} t^{2\alpha m} (-\partial_{\tilde{x}\tilde{x}})^{\alpha} \tilde{u} = -\tilde{u} + \tilde{v}|_{y=0}, & y = 0, t > 0, \\ -\partial_y \tilde{v}|_{y=0} = \tilde{u} - \tilde{v}|_{y=0}, & y = 0, t > 0. \end{cases} \quad (5.5.2)$$

Instead of solving (5.5.2) from $t = 0$, we choose to solve the initial problem (5.4.1) up to a time $\tilde{t} > 0$, and then to solve the rescaled problem (5.5.2) starting at $t = \tilde{t}$. This technique avoids restrictive CFL conditions, due to the coefficient $\frac{m}{t}$, and ensures the solution to be close to its stationary state in a non empty compact set. The time \tilde{t} is numerically defined as the first time for which the density u , solution to (5.4.1), reaches its stationary state 1.

The numerical procedure used to solve (5.5.2) is the same as in section 5.2 : the first and third equation of (5.5.2) are treated with a finite difference method, whereas a Strang splitting method solves the second equation of (5.5.2). Let us describe this splitting that have to include a transport term. Let t_0 be a positive constant and \tilde{u}_{t_0} be any piecewise continuous function, $\neq 0$, decaying faster than $|\tilde{x}|^{-(1+2\alpha)}$ at infinity.

1. The first step of the splitting includes the diffusive term of (5.5.2), which is

$$\begin{cases} \partial_t \tilde{u} + e^{-2\alpha t} t^{2\alpha m} (-\partial_{\tilde{x}\tilde{x}})^\alpha \tilde{u} = 0, & \tilde{x} \in \mathbb{R}, t > t_0, \\ \tilde{u}(\tilde{x}, t_0) = \tilde{u}_{t_0}(\tilde{x}), & \tilde{x} \in \mathbb{R}. \end{cases} \quad (5.5.3)$$

The solution to (5.5.3), denoted by $\tilde{X}^t u_{t_0}$, is explicitly given, for $\tilde{x} \in \mathbb{R}$ and $t > t_0$, by

$$\tilde{X}^t \tilde{u}_{t_0}(\tilde{x}, t) = \mathcal{F}^{-1} \left(\xi \mapsto e^{-|\xi|^{2\alpha} \int_{t_0}^t e^{-2\alpha s} s^{2\alpha m} ds} \mathcal{F}(\tilde{u}_{t_0})(\xi) \right) (\tilde{x}),$$

where \mathcal{F} and \mathcal{F}^{-1} are respectively the Fourier transform and the inverse Fourier transform in the space variable. The solution $\tilde{X}^t \tilde{u}_{t_0}$ is computed for small values of $(t - t_0)$ using the following first order approximation

$$\int_{t_0}^t e^{-2\alpha s} s^{2\alpha m} ds = (t - t_0) e^{-2\alpha t_0} t_0^{2\alpha m} + o(t - t_0),$$

and using Fast Fourier Transform (FFT) techniques. Note that FFT solvers require a small step size of discretisation in the \tilde{x} -variable.

2. The reaction and transport terms of (5.5.2) appear in the second step of the splitting, which is given by the transport equation :

$$\begin{cases} \partial_t \tilde{u}(\tilde{x}, t) - (l - \frac{m}{t}) \tilde{x} \partial_{\tilde{x}} \tilde{u}(\tilde{x}, t) = -\tilde{u}(\tilde{x}, t) + \tilde{v}(\tilde{x}, 0, t), & \tilde{x} \in \mathbb{R}, t > 0, \\ u(\tilde{x}, t_0) = \tilde{u}_{t_0}(\tilde{x}), & \tilde{x} \in \mathbb{R}. \end{cases} \quad (5.5.4)$$

The solution, denoted by $\tilde{Y}^t u_{t_0}$, has the explicit expression

$$\tilde{Y}^t \tilde{u}_{t_0}(\tilde{x}, t) = e^{-(t-t_0)} \tilde{u}_{t_0}(e^{lt} t^{-m} \tilde{x}) + \int_{t_0}^t e^{-(t-s)} v(e^{ls} t^{-m} \tilde{x}, 0, s) ds.$$

We fix constants $\tilde{X}_{max} > 0$ and $T > 0$, and solve (5.5.4) in the bounded domain $[-\tilde{X}_{max}, \tilde{X}_{max}]$ for $t \in [t_0, t_0 + T]$. The transport term is treated with a backward difference method if $\tilde{x} \geq 0$, and a forward difference method if $\tilde{x} \leq 0$. More precisely, given any large constants $J \in \mathbb{N}^*$ and $N \in \mathbb{N}^*$, the numerical procedure used to solve (5.5.4) consists in constructing, for $j \in \llbracket 0, J \rrbracket$ and $n \in \llbracket 0, N \rrbracket$, a sequence \tilde{u}_j^n that is supposed to approximate $\tilde{u}(\tilde{x}_j, t_n)$, with $dx = 2 \frac{\tilde{X}_{max}}{J}$, $dt = \frac{T}{N}$, $\tilde{x}_j = -\tilde{X}_{max} + j dx$ and $t_n = n dt$. The sequence \tilde{u}_j^n is defined by

- for all $j \in \llbracket 0, J \rrbracket$: $\tilde{u}_j^0 = \tilde{u}_{t_0}(x_j)$,
- for all $n \in \llbracket 0, N - 1 \rrbracket$ and $j \in \llbracket 1, J - 1 \rrbracket$:

$$\tilde{u}_j^{n+1} = \tilde{u}_j^n + \frac{dt}{dx} \left(l - \frac{m}{t_n} \right) \tilde{x}_j (\tilde{u}_{j+1}^n - \tilde{u}_j^n) + dt(-\tilde{u}_j^n + \tilde{v}(\tilde{x}_j, 0, t_n)), \text{ if } \tilde{x}_j \geq 0,$$

and

$$\tilde{u}_j^{n+1} = \tilde{u}_j^n + \frac{dt}{dx} \left(l - \frac{m}{t_n} \right) \tilde{x}_j (\tilde{u}_j^n - \tilde{u}_{j-1}^n) + dt(-\tilde{u}_j^n + \tilde{v}(\tilde{x}_j, 0, t_n)), \text{ if } \tilde{x}_j \leq 0.$$

- for all $n \in \llbracket 0, N \rrbracket$, the boundary conditions \tilde{u}_1^n and \tilde{u}_J^n have to be imposed. A first guess would consist in Dirichlet or Neumann boundary conditions. To check if one of these choices is relevant, we solve numerically the transport equation

$$\partial_t w(x, t) - c \partial_x w(x, t) = w(x, t) - w(x, t)^2, \quad x \in \mathbb{R}, t > 0, \quad (5.5.5)$$

for a constant $c > 0$, completed with an initial condition w_0 at time 0. The explicit solution is

$$w(x, t) = \frac{w_0(xe^{ct})}{w_0(xe^{ct}) + (1 - w_0(xe^{ct}))e^{-t}}. \quad (5.5.6)$$

Three cases are possible regarding the long time behaviour of w :

- if $w_0(x) = o(|x|^{-\frac{1}{c}})$ as $|x| \rightarrow +\infty$, then

$$w(x, t) \xrightarrow[t \rightarrow +\infty]{} 0, \quad \text{uniformly in } x,$$

- if $|x|^{\frac{1}{c}} = o(w_0(x)^{-1})$ as $|x| \rightarrow +\infty$, then

$$w(x, t) \xrightarrow[t \rightarrow +\infty]{} 1, \quad \text{uniformly in } x,$$

- if the function $x \mapsto w_0(x) |x|^{\frac{1}{c}}$ is bounded for large values of $|x|$, then

$$x \mapsto w(x, t) |x|^{\frac{1}{c}} \quad \text{is bounded as time } t \text{ goes to } +\infty, \text{ uniformly in } x.$$

In our case, due to the Strang splitting, we know that the initial condition considered in (5.5.4) comes from the solution to (5.5.3) at time $t_n + \frac{dt}{2}$, where dt is the time scale of the splitting. Consequently, it behaves like $|x|^{-(1+2\alpha)}$ at infinity. Let us take

$$w_0(x) = \frac{1}{1 + |x|^{1+2\alpha}}.$$

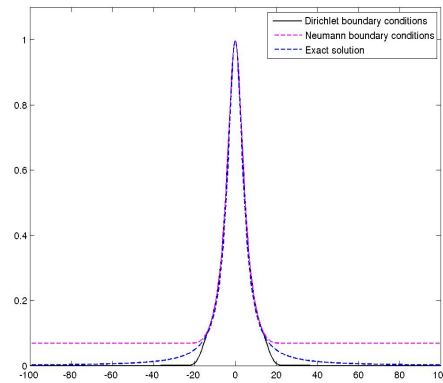

Figure 5.8: Problem (5.5.5) with $c = 2$ at time $t = 5$: comparaison between the exact solution and the numerical solutions with Dirichlet or Neumann boundary conditions.

With this choice and using the explicit expression (5.5.6) of the solution to the transport equation (5.5.5), with $c = \frac{1}{1+2\alpha}$, we know that, at any time, this solution decays like $|x|^{-(1+2\alpha)}$ at infinity.

Figure 5.8 shows that Dirichlet or Neumann boundary conditions are not precise enough to study long time behaviour of such a transport equation. Thus, natural boundary conditions are, for all $n \in \llbracket 0, N \rrbracket$

$$\tilde{u}_1^n = \frac{|x_1|^{1+2\alpha}}{|x_2|^{1+2\alpha}} \tilde{u}_2^n \quad \text{and} \quad \tilde{u}_J^n = \frac{|x_J|^{1+2\alpha}}{|x_{J-1}|^{1+2\alpha}} \tilde{u}_{J-1}^n. \quad (5.5.7)$$

Figure 5.9 suggests that this choice is relevant.

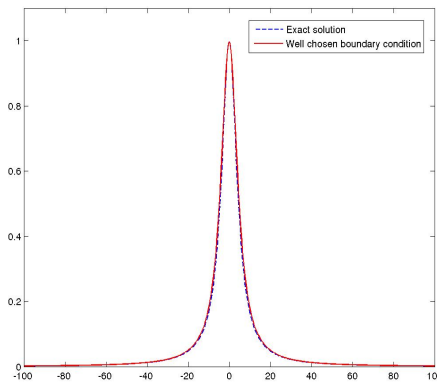

Figure 5.9: Problem (5.5.5) with $c = 2$ at time $t = 5$: comparaison between the exact solution and the numerical solution imposing the boundary conditions given in (5.5.7).

We refer to section 5.2 for a description of the numerical procedure used to solve the first and third equation of (5.5.2). Note that, as explained when analysing the behaviour of the solution to the transport equation (5.5.5), the boundary conditions of \tilde{v} on $\{-\tilde{X}_{max}\} \times [0, \tilde{Y}_{max}]$ and $\{\tilde{X}_{max}\} \times [0, \tilde{Y}_{max}]$ have to be carefully imposed. We use that this function should decay like $|\tilde{x}|^{-(1+2\alpha)}$ at infinity. This result is not proved in the thesis. However, since \tilde{v} has the same decay as v at infinity, the result proved in section 4.2.2 is useful. Indeed, we have bounded from below a subsolution to (5.4.1) at time 2. The result obtained in Lemma 4.2.2 is valid at any time $t > 0$. An upper bound of the function v could be computed using the linearised problem at 0 and the same computations as the one in section 4.3, where we have proved that the function u decays faster than $|x|^{-(1+2\alpha)}$ at infinity.

Let us describe the numerical results obtained for $\alpha = 0,5$, $\tilde{X}_{max} = 2000$ and $\tilde{Y}_{max} = 500$. Recall that we are investigating the rescaled problem (5.5.2) for \tilde{v} and \tilde{u} defined on $\mathbb{R} \times \mathbb{R}_+ \times \mathbb{R}_+$, by

$$\tilde{v}(\tilde{x}, y, t) = v(e^{lt}t^{-m}\tilde{x}, y, t) \quad \text{and} \quad \tilde{u}(\tilde{x}, t) = u(e^{lt}t^{-m}\tilde{x}, t),$$

with $l = \frac{1}{1+2\alpha}$ and $m \geq 0$ the constant that we want to study.

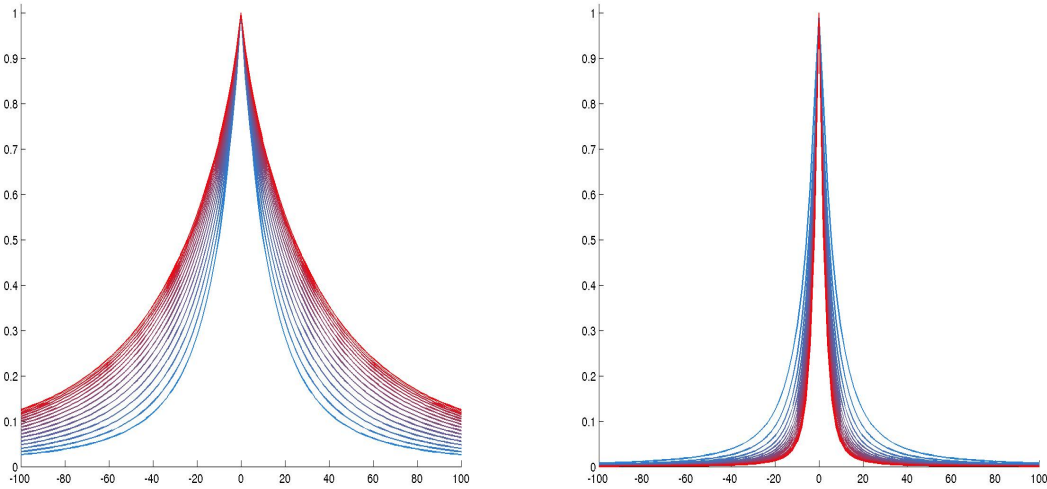

Figure 5.10: Evolution of the density \tilde{u} solution to (5.5.2), with $\alpha = 0,5$, for $m = 0$ (on the left) and $m = \frac{3}{1+2\alpha}$ (on the right), at successive times $t = 30, 40, 50, \dots, 200$ with a colour graduation from blue to red.

The left side of Figure 5.10, that concerns $m = 0$, shows that the level sets move faster than $e^{\frac{t}{1+2\alpha}}$, which illustrates Theorem 5.5.1. The right side of Figure 5.10, that concerns $m = \frac{3}{1+2\alpha}$, shows that the level sets move slower than $t^{-\frac{3}{1+2\alpha}} e^{\frac{t}{1+2\alpha}}$. Indeed, it seems that, in this case, the rescaled density \tilde{u} tends to δ_0 as t goes to infinity.

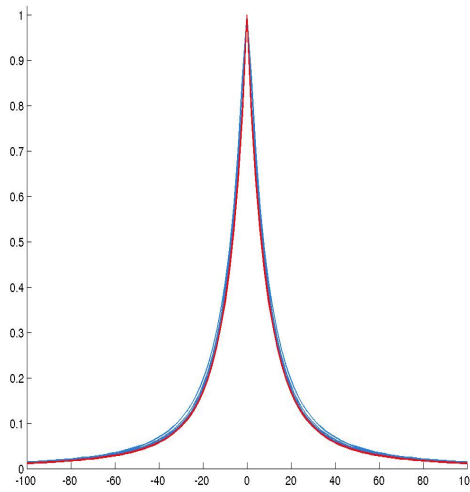

Figure 5.11: Evolution of the density \tilde{u} solution to (5.5.2), with $\alpha = 0,5$, for $m = \frac{3}{2(1+2\alpha)}$, at successive times $t = 30, 40, 50, \dots, 200$ with a colour graduation from blue to red.

Figure 5.11 concerns the particular choice $m = \frac{3}{2(1+2\alpha)}$, suggested by the upper bound of Theorem 5.5.1. On compact sets, the rescaled density \tilde{u} seems to converge to a function that does not move in time. This investigation hints that the asymptotic expression of the location of the level sets should be like $t^{-\frac{3}{2(1+2\alpha)}} e^{\frac{t}{1+2\alpha}}$.

Conclusion and Perspectives

In this thesis, we have set up a new method to study the long time behaviour of solutions to reaction problems involving integral diffusion. The starting point was to sharpen estimates of Cabré and Roquejoffre in [26]. This has enabled us to treat problems that would have been difficult to attack with the previously known arguments.

Part I of the thesis has been devoted to a rigorous analysis of the asymptotic location of the level sets of the solution to two different problems.

In Chapter 1, we have applied our method on a Fisher-KPP model in periodic media with fractional diffusion. We have been able to construct precise explicit subsolutions and supersolutions. Thus, we have proved that the transition between the unstable state and the stable one occurs exponentially fast in time, and we have obtained the precise exponent that appears in this exponential speed of propagation. This has led to the proof of the convergence of the solution to its stationary state on a set that expands with an exponential in time speed. Numerical simulations have been carried out to understand the dependence of the speed of propagation on the initial condition at lower order in time. Although the different numerical results, done for the homogeneous model in dimension two, have given a precise idea of what is happening, a mathematical proof should be undertaken. Indeed, it seems that there is a symmetrisation of the solution, in the sense of Jones in [57]. Proving this observation requires an estimate of the gradient of the solution, which is not done in this thesis. This geometric result of symmetrisation could also be studied in periodic media. Moreover, as suggested by numerical investigations, it seems that the diffusive term of the reaction-diffusion equation only plays a role for small times. It would be interesting to show it rigorously. Finally, one could think of further perspectives. A first one consists in getting similar results for integro-differential equations, and thus obtaining more precise asymptotics as the ones proved in [47]. More general heterogeneous media might also be analysed, media for which the notion of generalised eigenvalues is needed.

In Chapter 2, we have treated a cooperative reaction-diffusion system including fractional diffusion. Once again, the method given in the introduction of the thesis leads to the construction of explicit subsolutions and supersolutions to the system. This enables us to prove that the solution spreads exponentially fast in time, and we find the precise exponent of propagation depending, among others, on the smallest order of the diffusive terms involved in the system. The transition between standard reaction-diffusion systems and fractional reaction-diffusion systems remains to be in-

vestigated.

Part II of the thesis deals with a two dimensional environment, where reproduction of Fisher-KPP type and usual diffusion occur, except on a line of the plane, on which fractional diffusion takes place. The plane is referred to as "the field" and the line to "the road", as a reference to the biological situations we have in mind. Indeed, it has long been known that fast diffusion on roads can have a driving effect on the spread of epidemics. This new model shows the limits of the method described in the introduction of the thesis.

In Chapter 3, we have described the framework, using Hilbert spaces and the theory of sectorial operators. These choices have several advantages. The main one is to allow the computation of the fundamental solution through a Laplace integral. Also a comparison principle has been easily obtained. This framework is especially relevant as it has led to the existence, uniqueness and regularity of the solutions, for particular orders of the fractional diffusive term ($\alpha \in (1/4, 1)$).

In Chapter 4, we have studied the long time behaviour of the solution, composed of the densities on the road and in the field, to this two dimensional environment. We have proved that the speed of propagation is exponential in time on the road, whereas it depends linearly on time in the field. Contrary to the precise asymptotics obtained in Part I of the thesis, for this model, we are not able to give a sharp location of the level sets on the road and in the field, at least up to an $O(1)$ error. This lack of precision is due to the explicit subsolution, that we have constructed in a strip of large width. It would be of interest to find a subsolution in the whole half plane. Moreover, the study in the field could be improved, in order to get a more precise expansion shape. A Bramson type shift may occur, which would be interesting to understand.

In Chapter 5, we have carried out numerical simulations, that have outlined quite interesting perspectives. First, we have illustrated the theorems proved in [18, 17, 19], which has given an indication of the validity of the numerical procedure. The results have shown a surprising phenomenon close to the road. Indeed, the tangent lines to the level sets of the density in the field, at points touching the road, make an angle in $[0, \frac{\pi}{2})$ with the road. Moreover, this angle seems to decrease as the diffusion coefficient tends to infinity. It looks as if this phenomenon comes from the exchange term, that might play the role of a source term. It would be of interest to prove it rigorously. Then, we have illustrated the results of Chapter 4. This has shown a more precise shape of the expansion set in the field. Once again, this is something which needs to be mathematically investigated. Finally, we have carried out the numerical determination of the asymptotic location of the level sets on the road. Again to our surprise, our results have shown that the upper bound of this location, given by the supersolution that we have computed in Chapter 4, seems to give the precise expression of the speed of propagation. To understand this, perhaps with probabilistic tools, is a fascinating open problem.

Bibliography

- [1] M. Abramowitz and I. A. Stegun. *Handbook of mathematical functions with formulas, graphs, and mathematical tables*, volume 55 of *National Bureau of Standards Applied Mathematics Series*. For sale by the Superintendent of Documents, U.S. Government Printing Office, Washington, D.C., 1964.
- [2] R. A. Adams and J. J. K. Fournier. *Sobolev spaces*, volume 140 of *Pure and Applied Mathematics (Amsterdam)*. Elsevier/Academic Press, Amsterdam, second edition, 2003.
- [3] N. Alibaud, J. Droniou, and J. Vovelle. Occurrence and non-appearance of shocks in fractal Burgers equations. *J. Hyperbolic Differ. Equ.*, 4(3):479–499, 2007.
- [4] N. Alibaud and C. Imbert. Fractional semi-linear parabolic equations with unbounded data. *Trans. Amer. Math. Soc.*, 361(5):2527–2566, 2009.
- [5] D. G. Aronson and H. F. Weinberger. Nonlinear diffusion in population genetics, combustion, and nerve pulse propagation. In *Partial differential equations and related topics (Program, Tulane Univ., New Orleans, La., 1974)*, pages 5–49. Lecture Notes in Math., Vol. 446. Springer, Berlin, 1975.
- [6] D. G. Aronson and H. F. Weinberger. Multidimensional nonlinear diffusion arising in population genetics. *Adv. in Math.*, 30(1):33–76, 1978.
- [7] G. Barles, L. C. Evans, and P. E. Souganidis. Wavefront propagation for reaction-diffusion systems of PDE. *Duke Math. J.*, 61(3):835–858, 1990.
- [8] G. Barles, C. Georgelin, and P. E. Souganidis. Front propagation for reaction-diffusion equations arising in combustion theory. *Asymptot. Anal.*, 14(3):277–292, 1997.
- [9] G. Barles and P. E. Souganidis. A new approach to front propagation problems: theory and applications. *Arch. Rational Mech. Anal.*, 141(3):237–296, 1998.
- [10] H. Berestycki. *Nonlinear PDE's in Condensed Matter and Reactive Flows*, volume 569 of *NATO Science series C: Mathematical and physical Sciences*. Kluwer Acad. Publ., Dordrecht, NL, 2002.

-
- [11] H. Berestycki, F. Hamel, and G. Nadin. Asymptotic spreading in heterogeneous diffusive excitable media. *J. Funct. Anal.*, 255(9):2146–2189, 2008.
- [12] H. Berestycki, F. Hamel, and N. Nadirashvili. The speed of propagation for KPP type problems. I. Periodic framework. *J. Eur. Math. Soc. (JEMS)*, 7(2):173–213, 2005.
- [13] H. Berestycki, F. Hamel, and N. Nadirashvili. The speed of propagation for KPP type problems. II. General domains. *J. Amer. Math. Soc.*, 23(1):1–34, 2010.
- [14] H. Berestycki, F. Hamel, and L. Roques. Analysis of the periodically fragmented environment model. I. Species persistence. *J. Math. Biol.*, 51(1):75–113, 2005.
- [15] H. Berestycki and B. Larrouturou. Quelques aspects mathématiques de la propagation des flammes prémélangées. In *Nonlinear partial differential equations and their applications. Collège de France Seminar, Vol. X (Paris, 1987–1988)*, volume 220 of *Pitman Res. Notes Math. Ser.*, pages 65–129. Longman Sci. Tech., Harlow, 1991.
- [16] H. Berestycki, J.-M. Roquejoffre, and L. Rossi. The periodic patch model for population dynamics with fractional diffusion. *Discrete Contin. Dyn. Syst. Ser. S*, 4(1):1–13, 2011.
- [17] H. Berestycki, J.-M. Roquejoffre, and L. Rossi. Fisher-KPP propagation in the presence of a line : further effects. *arXiv:1303.1091 [math.AP]*, 2013.
- [18] H. Berestycki, J.-M. Roquejoffre, and L. Rossi. The influence of a line with fast diffusion on Fisher-KPP propagation. *J. Math. Biol.*, 66(4-5):743–766, 2013.
- [19] H. Berestycki, J.-M. Roquejoffre, and L. Rossi. The shape of expansion induced by a line with fast diffusion in Fisher-KPP equations. *arXiv:1402.1441 [math.AP]*, 2014.
- [20] R. M. Blumenthal and R. K. Gettoor. Some theorems on stable processes. *Trans. Amer. Math. Soc.*, 95:263–273, 1960.
- [21] M. Bonforte and J. L. Vázquez. Quantitative local and global a priori estimates for fractional nonlinear diffusion equations. *Adv. Math.*, 250:242–284, 2014.
- [22] M. D. Bramson. Convergence of solutions of the Kolmogorov equation to traveling waves. *Mem. Amer. Math. Soc.* 44, pages iv+190, 1983.
- [23] J. Busca and B. Sirakov. Harnack type estimates for nonlinear elliptic systems and applications. *Ann. Inst. H. Poincaré Anal. Non Linéaire*, 21(5):543–590, 2004.

- [24] X. Cabré, A.-C. Coulon, and J.-M. Roquejoffre. Propagation in Fisher-KPP type equations with fractional diffusion in periodic media. *C. R. Math. Acad. Sci. Paris*, 350(19-20):885–890, 2012.
- [25] X. Cabré and J.-M. Roquejoffre. Front propagation in Fisher-KPP equations with fractional diffusion. *C. R. Math. Acad. Sci. Paris*, 347:1361–1366, 2009.
- [26] X. Cabré and J.-M. Roquejoffre. The influence of fractional diffusion in Fisher-KPP equations. *Comm. Math. Phys.*, 320(3):679–722, 2013.
- [27] X. Cabré and Y. Sire. Nonlinear equations for fractional Laplacians, II: Existence, uniqueness and qualitative properties of solutions. *arXiv:1111.0796 [math.AP]*, 2011.
- [28] X. Cabré and Y. Sire. Nonlinear equations for fractional Laplacians, I: Regularity, maximum principles, and Hamiltonian estimates. *Ann. Inst. H. Poincaré Anal. Non Linéaire*, 31(1):23–53, 2014.
- [29] X. Cabré and J. Solà-Morales. Layer solutions in a half-space for boundary reactions. *Comm. Pure Appl. Math.*, 58(12):1678–1732, 2005.
- [30] L. A. Caffarelli, C. H. Chan, and A. Vasseur. Regularity theory for parabolic nonlinear integral operators. *J. Amer. Math. Soc.*, 24(3):849–869, 2011.
- [31] L. A. Caffarelli, J.-M. Roquejoffre, and O. Savin. Nonlocal minimal surfaces. *Comm. Pure Appl. Math.*, 63(9):1111–1144, 2010.
- [32] L. A. Caffarelli, J.-M. Roquejoffre, and Y. Sire. Variational problems for free boundaries for the fractional Laplacian. *J. Eur. Math. Soc. (JEMS)*, 12(5):1151–1179, 2010.
- [33] L. A. Caffarelli and L. Silvestre. An extension problem related to the fractional Laplacian. *Comm. Partial Differential Equations*, 32(7-9):1245–1260, 2007.
- [34] L. A. Caffarelli and P. E. Souganidis. Convergence of nonlocal threshold dynamics approximations to front propagation. *Arch. Ration. Mech. Anal.*, 195(1):1–23, 2010.
- [35] L. A. Caffarelli and A. Vasseur. Drift diffusion equations with fractional diffusion and the quasi-geostrophic equation. *Ann. of Math. (2)*, 171(3):1903–1930, 2010.
- [36] J. S. Clark, C. Fastie, G. Hurtt, S. T. Jackson, C. Johnson, G. A. King, M. Lewis, J. Lynch, S. Pacala, C. Prentice, E. W. Schupp, I. I. I. T. Webb, and P. Wyckoff. Reid’s paradox of rapid plant migration. *BioScience*, 48, 1998.
- [37] P. Constantin and V. Vicol. Nonlinear maximum principles for dissipative linear nonlocal operators and applications. *Geom. Funct. Anal.*, 22(5):1289–1321, 2012.

- [38] A.-C. Coulon and J.-M. Roquejoffre. Transition between linear and exponential propagation in Fisher-KPP type reaction-diffusion equations. *Comm. Partial Differential Equations*, 37(11):2029–2049, 2012.
- [39] J. Dávila, M. del Pino, and J. Wei. Nonlocal minimal lawson cones. *arXiv:1303.0593 [math.AP]*, 2013.
- [40] J. Droniou and C. Imbert. Fractal first-order partial differential equations. *Arch. Ration. Mech. Anal.*, 182(2):299–331, 2006.
- [41] A. Erdélyi. *Higher Transcendental Functions*, volume 2. McGraw-Hill Book Company, Inc., New York-Toronto-London, 1953.
- [42] L. C. Evans. *Partial differential equations*. Graduate Studies in Mathematics. American Mathematical Society, Providence, RI, second edition, 2010.
- [43] L. C. Evans and P. E. Souganidis. A PDE approach to certain large deviation problems for systems of parabolic equations. *Ann. Inst. H. Poincaré Anal. Non Linéaire*, 6(suppl.):229–258, 1989. *Analyse non linéaire (Perpignan, 1987)*.
- [44] L. C. Evans and P. E. Souganidis. A PDE approach to geometric optics for certain semilinear parabolic equations. *Indiana Univ. Math. J.*, 38(1):141–172, 1989.
- [45] R. A. Fisher. The wave of advance of advantageous genes. *Ann. Eugenics* 7, pages 353–369, 1937.
- [46] R. L. Frank and E. Lenzmann. Uniqueness of non-linear ground states for fractional Laplacians in \mathbb{R} . *Acta Math.*, 210(2):261–318, 2013.
- [47] J. Garnier. Accelerating solutions in integro-differential equations. *SIAM J. Math. Anal.*, 43(4):1955–1974, 2011.
- [48] J. Gärtner. Location of wave fronts for the multidimensional KPP equation and Brownian first exit densities. *Math. Nachr.*, 105:317–351, 1982.
- [49] J. Gärtner and M. I. Freidlin. The propagation of concentration waves in periodic and random media. *Dokl. Akad. Nauk SSSR*, 249(3):521–525, 1979.
- [50] F. Hamel, J. Nolen, J.-M. Roquejoffre, and L. Ryzhik. A short proof of the logarithmic Bramson correction in Fisher-KPP equations. *Netw. Heterog. Media*, 8(1):275–289, 2013.
- [51] F. Hamel and L. Roques. Fast propagation for KPP equations with slowly decaying initial conditions. *J. Differential Equations*, 249(7):1726–1745, 2010.
- [52] E. Hansen, F. Kramer, and A. Ostermann. A second-order positivity preserving scheme for semilinear parabolic problems. *Appl. Numer. Math.*, 62(10):1428–1435, 2012.

- [53] D. Henry. *Geometric Theory of Semilinear Parabolic Equations*. Springer-Verlag, New York, 1981.
- [54] M. W. Hirsch. Stability and convergence in strongly monotone dynamical systems. *J. Reine Angew. Math.*, 383:1–53, 1988.
- [55] N. E. Humphries, N. Queiroz, J. R. M. Dyer, N. G. Pade, M. K. Musyl, K. M. Schaefer, D. W. Fuller, J. M. Brunnschweiler, T. K. Doyle, J. Houghton, G. C. Hays, C. S. Jones, L. R. Noble, V. J. Wearmouth, E. J. Southall, and D. W. Sims. Environmental context explains levy and brownian movement patterns of marine predators. *Nature*, 465(7301):1066–1069, 2010.
- [56] C. Imbert, R. Monneau, and E. Rouy. Homogenization of first order equations with (u/ϵ) -periodic Hamiltonians. II. Application to dislocations dynamics. *Comm. Partial Differential Equations*, 33(1-3):479–516, 2008.
- [57] C. K. R. T. Jones. Spherically symmetric solutions of a reaction-diffusion equation. *J. Differential Equations*, 49(1):142–169, 1983.
- [58] S. Kesavan. *Topics in functional analysis and applications*. John Wiley & Sons Inc., New York, 1989.
- [59] A. Kiselev, F. Nazarov, and R. Shterenberg. Blow up and regularity for fractal burgers equation. *Dynamics of Partial Differential Equations*, 5(3):211–240, 2008.
- [60] A. Kiselev, F. Nazarov, and A. Volberg. Global well-posedness for the critical 2D dissipative quasi-geostrophic equation. *Invent. Math.*, 167(3):445–453, 2007.
- [61] A. N. Kolmogorov, I. G. Petrovskii, and N. S. Piskunov. Etude de l'équation de diffusion avec accroissement de la quantité de matière, et son application à un problème biologique. *Bjul. Moskowskogo Gos. Univ.*, 17:1–26, 1937.
- [62] V. Kolokoltsov. Symmetric stable laws and stable-like jump-diffusions. *Proc. London Math. Soc. (3)*, 80(3):725–768, 2000.
- [63] O. A. Ladyzenskaya, N. A. Solonnikov, and N. N. Ural'tzeva. *Linear and Quasilinear Equations of Parabolic Type*. Translations of mathematical monographs. American Mathematical Society, Providence, RI, 1968.
- [64] N. S. Landkof. *Foundations of modern potential theory*, volume 180 of *Grundlehren der mathematischen Wissenschaften [Fundamental Principles of Mathematical Sciences]*. Springer-Verlag, 1972.
- [65] M. A. Lewis, B. Li, and H. F. Weinberger. Analysis of linear determinacy for spread in cooperative models. *J. Math. Biol.*, 45(3):183–218, 2002.

- [66] M. A. Lewis, B. Li, and H. F. Weinberger. Spreading speed and linear determinacy for two-species competition models. *J. Math. Biol.*, 45(3):219–233, 2002.
- [67] M. A. Lewis, B. Li, and H. F. Weinberger. Anomalous spreading speeds of cooperative recursion systems. *J. Math. Biol.*, 55(2):207–222, 2007.
- [68] R. Lui. Biological growth and spread modeled by systems of recursions. I. Mathematical theory. *Math. Biosci.*, 93(2):269–295, 1989.
- [69] R. Lui. Biological growth and spread modeled by systems of recursions. II. Biological theory. *Math. Biosci.*, 93(2):297–312, 1989.
- [70] J.-F. Mallordy and J.-M. Roquejoffre. A parabolic equation of the KPP type in higher dimensions. *SIAM J. Math. Anal.*, 26(1):1–20, 1995.
- [71] R. Mancinelli, D. Vergni, and A. Vulpiani. Front propagation in reactive systems with anomalous diffusion. *Phys. D*, 185(3-4):175–195, 2003.
- [72] J. D. Murray. *Mathematical Biology - II: Spatial models and biomedical applications*, volume 18. Interdisciplinary applied mathematics - Springer, third edition, 1993.
- [73] E. Di Nezza, G. Palatucci, and E. Valdinoci. Hitchhiker’s guide to the fractional Sobolev spaces. *Bull. Sci. Math.*, 136(5):521–573, 2012.
- [74] A. Pazy. *Semigroups of linear operators and applications to partial differential equations*, volume 44 of *Applied Mathematical Sciences*. Springer-Verlag, New York, 1983.
- [75] G. Polya. On the zeros of an integral function represented by Fourier’s integral. *Messenger of Math.*, 52:185–188, 1923.
- [76] J.-M. Roquejoffre and L. Ryzhik. KPP invasions in periodic media: lecture notes for the Toulouse KPP school. 2014.
- [77] V. Roussier. Stability of radially symmetric travelling waves in reaction-diffusion equations. *Ann. Inst. H. Poincaré Anal. Non Linéaire*, 21(3):341–379, 2004.
- [78] N. Shigesada, K. Kawasaki, and E. Teramoto. Traveling periodic waves in heterogeneous environments. *Theoret. Population Biol.*, 30(1):143–160, 1986.
- [79] A. Siegfried. Itinéraires des contagions, épidémies et idéologies. *Revue d’histoire des sciences et de leurs applications*, 14(3):369–371, 1961.
- [80] L. Silvestre. Hölder estimates for solutions of integro-differential equations like the fractional Laplace. *Indiana Univ. Math. J.*, 55(3):1155–1174, 2006.

-
- [81] J. G. Skellam. Random dispersal in theoretical populations. *Biometrika*, 38:196–218, 1951.
- [82] G. Strang. On the construction and comparison of difference schemes. *SIAM J. Numer. Anal.*, 5:506–517, 1968.
- [83] H. F. Weinberger. On spreading speeds and traveling waves for growth and migration models in a periodic habitat. *J. Math. Biol.*, pages 511–548, 2002.
- [84] F. A. Williams. *Combustion Theory*. Benjamin Cummings, Menlo Park, Addison-Wesley, second edition, 1985.
- [85] M. Yangari. *Fractional Reaction-Diffusion Problems*. PhD thesis, Universidad de Chile - Santiago de Chile, 2014.