

EFFECT OF SODIUM CHANNEL SNVS ASSOCIATED TO ARRHYTHMOGENIC DISEASES. MODULATORY ROLE OF THE GENETIC BACKGROUND

Rebecca Martinez Moreno

Per citar o enllaçar aquest document:
Para citar o enlazar este documento:
Use this url to cite or link to this publication:
<http://hdl.handle.net/10803/285269>

ADVERTIMENT. L'accés als continguts d'aquesta tesi doctoral i la seva utilització ha de respectar els drets de la persona autora. Pot ser utilitzada per a consulta o estudi personal, així com en activitats o materials d'investigació i docència en els termes establerts a l'art. 32 del Text Refós de la Llei de Propietat Intel·lectual (RDL 1/1996). Per altres utilitzacions es requereix l'autorització prèvia i expressa de la persona autora. En qualsevol cas, en la utilització dels seus continguts caldrà indicar de forma clara el nom i cognoms de la persona autora i el títol de la tesi doctoral. No s'autoritza la seva reproducció o altres formes d'explotació efectuades amb finalitats de lucre ni la seva comunicació pública des d'un lloc aliè al servei TDX. Tampoc s'autoritza la presentació del seu contingut en una finestra o marc aliè a TDX (framing). Aquesta reserva de drets afecta tant als continguts de la tesi com als seus resums i índexs.

ADVERTENCIA. El acceso a los contenidos de esta tesis doctoral y su utilización debe respetar los derechos de la persona autora. Puede ser utilizada para consulta o estudio personal, así como en actividades o materiales de investigación y docencia en los términos establecidos en el art. 32 del Texto Refundido de la Ley de Propiedad Intelectual (RDL 1/1996). Para otros usos se requiere la autorización previa y expresa de la persona autora. En cualquier caso, en la utilización de sus contenidos se deberá indicar de forma clara el nombre y apellidos de la persona autora y el título de la tesis doctoral. No se autoriza su reproducción u otras formas de explotación efectuadas con fines lucrativos ni su comunicación pública desde un sitio ajeno al servicio TDR. Tampoco se autoriza la presentación de su contenido en una ventana o marco ajeno a TDR (framing). Esta reserva de derechos afecta tanto al contenido de la tesis como a sus resúmenes e índices.

WARNING. Access to the contents of this doctoral thesis and its use must respect the rights of the author. It can be used for reference or private study, as well as research and learning activities or materials in the terms established by the 32nd article of the Spanish Consolidated Copyright Act (RDL 1/1996). Express and previous authorization of the author is required for any other uses. In any case, when using its content, full name of the author and title of the thesis must be clearly indicated. Reproduction or other forms of for profit use or public communication from outside TDX service is not allowed. Presentation of its content in a window or frame external to TDX (framing) is not authorized either. These rights affect both the content of the thesis and its abstracts and indexes.



DOCTORAL THESIS

Effect of sodium channel SNVs associated to arrhythmogenic diseases. Modulatory role of the genetic background.

Rebecca Martinez Moreno

2021



Institut
d'Investigació
Biomèdica
de Girona
Dr. Josep Trueta

DOCTORAL THESIS

Effect of sodium channel SNVs associated to arrhythmogenic diseases. Modulatory role of the genetic background.

Rebecca Martinez Moreno

2021

Doctorat en Biologia Molecular, Biomedicina i Salut

Dirigida per:

Dra. Fabiana Silvia Scornik Gerzenstein i Dra. Elisabet Selga Coma

Tutora: Dra. Fabiana Silvia Scornik Gerzenstein

Memòria presentada per optar al títol de doctora per la Universitat de Girona

1 Annex



Institut
d'Investigació
Biomèdica
de Girona
Dr. Josep Trueta

La **Dra. Fabiana Scornik**, professora de la Facultat de Medicina de la Universitat de Girona i codirectora de la unitat d'electrofisiologia del Centre de Genètica Cardiovascular de l'Institut d'Investigació Biomèdica de Girona i de la Universitat de Girona.

La **Dra. Elisabet Selga Coma**, professora de la Facultat de Medicina de la Universitat de Vic – Universitat central de Catalunya.

DECLAREM:

Que el treball titulat “**Effect of sodium channel SNVs associated to arrhythmogenic diseases. Modulatory role of the genetic background**”, que presenta **Rebecca Martinez Moreno** per a l'obtenció del títol de doctor/a, ha estat realitzat sota la nostra direcció i que compleix els requisits per poder optar a Menció Internacional.

I, perquè així consti i tingui els efectes oportuns, signem aquest document.

Girona, 26 de Març del 2021

Acknowledgements

Después de todo lo pasado redactando esta Tesis, ha llegado **por fin** el momento de escribir los agradecimientos. Veréis una mezcla de idiomas, pero quien me conoce ya sabe que es lo que hago normalmente cuando hablo.

Como no podía ser de otra manera, en primer lugar, quiero agradecer a mis directoras de tesis todo lo que han hecho por mí. Fabi, gracias por confiar des del principio en mí para tirar adelante este maravilloso proyecto. Has conseguido que una persona que no sabía prácticamente nada de electrofisiología, la acabara apreciando hasta el punto de querer dedicar mi futuro profesional a este ámbito. Lo de entenderla del todo ya es otro tema, pero, como tú siempre dices, es algo que conlleva muchos años. Eli, gràcies per haver-me ensenyat tot el que saps de cultius cel·lulars, que no és poc! Sense tu, a hores d'ara no sabia ni canviar-li el medi a un flascó de HEKs. També per tota la teva saviesa en l'àmbit molecular en general. Muchas gracias a las dos por haberme enseñado tantísimas cosas y por vuestra paciencia. Por darme la posibilidad de ir a los mejores congresos en USA, y al curso de Plymouth. Por corregirme minuciosamente cada *abstract*, aplicaciones para becas y el artículo entre otras muchas cosas. Y, sobre todo, por vuestras correcciones en la redacción de esta tesis, que es tanto mía como vuestra. Nunca os lo podré agradecer lo suficiente.

Más allá del ámbito educativo, os agradezco muchísimo vuestra cercanía. Me habéis ayudado muchísimo en mis peores momentos. Habéis confiado en mí cuando ni yo misma lo hacía, y me habéis hecho tirar hacia adelante siempre. Sois unas personas maravillosas, y soy extremadamente afortunada de haberos tenido ahí durante todos estos años.

Gracias también a Guille, el revisor por excelencia. Por tus ánimos y todos tus consejos, aunque no te gustaran los rombos de mis posters. También me siento muy afortunada de haber tenido a mi lado una persona como tú.

Vull agrair també a en Ramon per haver-me deixat formar part de Gencardio, i també per donar-me la oportunitat d'implicar-me en el projecte de l'Alexandra. Això em porta a l'Alexandra, una de les persones que també m'ha ajudat moltíssim en aquesta tesis. Gràcies per tot: pels teus consells, les xerrades (tant sobre ciència com d'altres temes) i per ser com ets amb mi. També

per mimar-me tant portant-me xuxes i dolços varis. Gràcies també als altres membres de LDG: Mònica, Ferran, Marta P, Laura i Nuria; i a l'Anna I i a en Carles.

Gràcies a la Mireia, la Sara i en Marcel per tota la vostra ajuda. També als ex-predocs: Mel·lina, Bernat, Txús i Èric; i als predocs actuals: David, Marta V, Anna F i Yajaira. A l'Adrià, que és quasi tant friki com jo i hem pogut parlar de temes de vital importància com són els videojocs.

A en David li vull dedicar algunes paraules més. Gràcies per totes les hores interminables de cultius (que donen per parlar de moltes coses) i d'experiments junts. Per aguantar el meu mal caràcter (encara que sé que el trobaries a faltar) i tots els meus drames. Gràcies per ajudar-me tant, i per la custòdia compartida de les nostres *cells* els caps de setmana i festius. Sense tu hauria acabat boja (ja, ja ho sé, més de lo que estic de naixement). Ja ho diu la Bet sempre que fem un bon equip.

Bet, la meva mutada preferida, què hauria sigut de mi sense tu? Gràcies per tots els moments a cultius i per la teva ajuda, ets una font de saviesa sense límits. També pels teus concerts amb coreografia incorporada. Gràcies també a la Sara de l'ICO, la Bet i tu sou un duo meravellós.

Thank you to my bitchy cluster (sorry for the bad word, that's who we are) from the Microelectrodes course at Plymouth: Oscar, Marta, Sarah, Laura, Marcella and Mario. I had the best time there thanks to you guys. I hope that in the future we can reunite to *ballenying* more together.

I would like to thank too all the people at Brown University, who made me feel so comfortable in their lab. Specially to Dr. Koren for giving me the opportunity of learning so much in his research group, and Anatoli for your patience and all the funny moments with you.

Ahora pasemos a la lista de amigos y familia. Mis nenas bonicas: Maria, Sara y Sílvia. Gracias por absolutamente todo lo que habéis hecho por mí, son demasiadas cosas como para resumirlas aquí. Llevamos muchísimos años juntas y espero que sean muchísimos años más. Sois las mejores amigas que una persona podría desear, y aunque sé que no lo demuestro mucho os quiero con todo mi *kokoro*.

A las que han seguido ahí tras acabar la uni: Clara y las dos Irenes. Gracias por los maravillosos años de uni con vosotras y los que han venido después. Por todo lo que hemos vivido juntas. Marc, gracias también a ti por todo tu apoyo durante todos estos años. Ya sabes que siempre te

he deseado lo mejor ya sea en Bilbao, Dinamarca o donde quiera que vayas a continuación, ¡pero te echo mucho de menos!

Gracias por el apoyo y los ánimos a mis compañeros de frikadas en general: Sabo y Esteve.

A mi hermana, Maggie. Pese a los miles de Km que nos separan, has sido y eres un pilar fundamental en mi vida. Gracias por todo tu apoyo, tus consejos, y por compartir conmigo todas las frikadas que tanto nos gustan. Gracias por acogerme en tu casa durante mi estancia en Brown (and thanks to Matt too!), y por todas las experiencias vividas juntas. Te quiero.

A mi padre, gracias por todo el cariño que me diste y por ser la persona más bondadosa que he conocido en toda mi vida. Te echo y te echaré siempre de menos, pero sé que estarías muy orgulloso de mí. He sido muy afortunada al tener un padre como tú.

A mis gatos, Odin y Kylo, que también forman parte de mi pequeña familia porque son como hijos para mí. Todos sabéis que soy la definición de diccionario de loca de los gatos, así que este agradecimiento no podía faltar. Gracias por hacerme tantísima compañía y por vuestro amor incondicional.

Gracias a Maria Gracia y Cristina por haber pasado a formar parte de mi familia. Por vuestro apoyo, y por lo muchísimo que me cuidáis. También a Pepa, por ser la perrita más amorosa del mundo.

Finalmente, a Joan. Gracias por cuidarme y por apoyarme, tanto en lo bueno como en lo malo. Por animarme a seguir cuando ya no podía más, y por escuchar todos mis problemas. Por hacerme sentir tan querida, pese a que soy una persona muy complicada. Aún nos queda mucho por vivir juntos, te quiero.

“And blood-black nothingness began to spin.
A system of cells interlinked within
Cells interlinked within cells interlinked
Within one stem. And dreadfully distinct
Against the dark, a tall white fountain played.”
Vladimir Nabokov, Pale Fire

Scientific publications derived from this Thesis

Rebecca Martinez-Moreno, Helena Riuró, Elisabet Selga, Michael F. Wangler, Ramon Brugada, Guillermo J. Pérez, Fabiana S. Scornik. An *SCN1B* Variant Found in a Child Diagnosed with Epilepsy and Brugada Syndrome Modifies Brain-Type (Nav1.1) and Cardiac-Type (Nav1.5) Sodium Currents. *Biophysical Journal*. **3**, 490a (2018).

Rebecca Martinez-Moreno, Elisabet Selga, Georgia Sarquella-Brugada, Ramon Brugada, Guillermo J. Pérez, Fabiana S. Scornik. Cardiac Sodium Current is Severely Impaired in Induced Pluripotent Stem Cell-Derived Cardiomyocytes from Brugada Syndrome Patients. *Biophysical Journal*. **3**, 390a-391a (2019).

Rebecca Martinez-Moreno, David Carreras, Elisabet Selga, Georgia Sarquella-Brugada, Ramon Brugada, Guillermo J. Pérez, Fabiana S. Scornik. Comparative Study of the Effects of an *SCN5A* Mutation within a Family Diagnosed with Brugada Syndrome using iPS-CM. *Biophysical Journal*. **3**, 500a (2020).

Rebecca Martinez-Moreno, Elisabet Selga, Helena Riuró, David Carreras, Mered Parnes, Chandra Srinivasan, Michael F. Wangler, Guillermo J. Pérez, Fabiana S. Scornik, Ramon Brugada. An *SCN1B* Variant Affects Both Cardiac-Type (Nav1.5) and Brain-Type (Nav1.1) Sodium Currents and Contributes to Complex Concomitant Brain and Cardiac Disorders. *Frontiers in Cell and Developmental Biology*. **8**, 1-17 (2020).

Abbreviations

A	Absorbance
AC	Arrhythmogenic cardiomyopathy
AF	Atrial fibrillation
Amp	Ampicillin
AP	Action potential
AVN	Atrioventricular node
BrS	Brugada Syndrome
BSA	Bovine serum albumin
C	Coulombs
CAM	Cell adhesion molecules
cDNA	Complementary DNA
CPVT	Catecholaminergic polymorphic ventricular tachycardia
Dex	Dexamethasone
DMEM	Dulbecco's Modified Eagle's Medium
DMSO	Dimethyl sulfoxide
DN	Dominant negative
DNA	Deoxyribonucleic acid
dNTPs	Deoxynucleotides
DS	Dravet Syndrome
E-C	Excitation-contraction
ECG	Electrocardiogram
EDTA	Ethylenediaminetetraacetic acid
E_m	Membrane potential
ES	Embryonic stem
FBS	Fetal bovine serum
FCS	Fetal calf serum
FW	Forward

GEFS+	Generalized epilepsy with febrile seizures plus
HEK-293T	Human embryonic kidney-293 tsA201
Ig	Immunoglobulin
I_{Na}	Sodium current
iPSc	Induced pluripotent stem cells
iPS-CM	iPSc-derived cardiomyocytes
I-V	Current-voltage
KOSR	Knock out serum replacement
LQT	Long QT
mV	Millivolts
O/D	Overday
O/N	Overnight
PBS	Phosphate-buffered saline
PCR	Polymerase chain reaction
PD	Pore domain
Pen-Strep	Penicillin-Streptomycin
qPCR	Quantitative PCR
RNA	Ribonucleic acid
ROCKi	Y-27632 2HCl ROCK1 inhibitor
Rq	Relative quantification
SERCA	Sarcoplasmic reticulum calcium transport ATPase
SR	Sarcoplasmic reticulum
RT	Room temperature
RV	Reverse
RVOT	Right ventricular outflow tract
SAN	Sinoatrial node
SCD	Sudden cardiac death
SIDS	Sudden infant death syndrome
SNV	Single nucleotide variant
SQT	Short QT
SUDEP	Sudden unexpected death in epilepsy

T3	3,3',5-Triiodo-L-thyronine
TeSR	Stem cell selection media
VF	Ventricular fibrillation
VGSC	Voltage-gated sodium channels
VSD	Voltage-sensing domain
WT	Wild type

Contents

Acknowledgements	i
Scientific publications derived from this Thesis	vii
Abbreviations	ix
Contents	xiii
Figures	xix
Tables	xxiii
Summary	1
Resum	5
Resumen	9
I. Introduction	15
1. Inherited arrhythmogenic diseases or channelopathies	15
1.1. Neurological channelopathies	17
1.2. Incomplete penetrance and variable expressivity	17
1.2.1. Genetic factors	18
1.2.2. Environmental factors	19
2. Voltage-gated sodium channels	20
2.1. Genes, molecular structure and function of α subunits	20
2.2. Genes, molecular structure and function of β subunits	22
2.3. Biophysical properties of voltage-gated sodium channels	24
2.3.1. Closed state	26
2.3.2. Open state	26
2.3.3. Inactivated state	29
2.3.4. Closed-Inactivated state	30
3. Experimental cellular models for the study of mutations affecting voltage-gated sodium channels	32
3.1. Heterologous expression systems	32
3.2. Tissue-specific cells derived from induced pluripotent stem cells (iPSc)	33
3.2.1. iPSc-derived neurons	35
3.2.2. iPSc-derived cardiomyocytes (iPS-CM)	35
4. Electrical heart activity	37
4.1. Cardiac action potential (AP)	37

4.2. Electrocardiogram (ECG)	41
5. Sudden cardiac death (SCD)	43
5.1. SCD risk factors.....	43
5.2. SCD cases.....	44
5.3. Cardiac channelopathies	44
5.3.1. Diseases associated with sodium channel dysfunction	46
5.3.2. Diseases associated with potassium channel dysfunction	46
5.3.3. Diseases associated with calcium channel dysfunction.....	47
6. Brugada Syndrome (BrS)	48
6.1. Phenotype, diagnosis and treatment.....	48
6.2. Implicated genes	51
6.3. Pathophysiological mechanisms of BrS.....	53
6.4. Experimental cellular models in Brugada Syndrome	54
6.4.1. Heterologous expression systems in BrS	54
6.4.2. iPS-CM in BrS.....	55
II. Rationale of the research	59
1. <i>SCN1B</i> variant associated with concomitant brain and cardiac disorders	60
2. <i>SCN5A</i> variant associated with Brugada Syndrome.....	63
III. Hypotheses and Specific Aims	69
1. <i>SCN1B</i> variant associated with concomitant brain and cardiac disorders	69
2. <i>SCN5A</i> variant associated with Brugada Syndrome.....	70
IV. Methods	73
1. Materials	73
1.1. Cellular lines	73
1.1.1. Bacteria	73
1.1.2. HEK-293T.....	73
1.1.3. Fibroblasts	74
1.1.4. Induced pluripotent stem cells	74
1.1.5. Induced pluripotent stem cell-derived cardiomyocytes.....	74
1.2. Expression vectors	76
1.3. Antibodies	76
1.4. Western Blot and Biotinylation assay buffers.....	76
1.5. Patch Clamp solutions.....	77
1.6. Other material references.....	78

1.6.1. Reagents.....	78
1.6.2. Consumables	79
1.6.3. Equipments	80
1.6.4. Software	81
2. Heterologous expression of the SNVs.....	82
2.1. Site-directed mutagenesis	82
2.2. Transformation in bacterial culture	83
2.3. Vector purification	83
2.4. HEK-293T cell culture	85
3. Obtaining of patient-specific iPS-CM	86
3.1. Obtaining of skin biopsies	86
3.2. Obtaining of fibroblasts	86
3.3. Fibroblasts reprogramming to iPS cells	87
3.4. Differentiation of iPS cells to iPS-CM	88
3.4.1. iPS culture.....	88
3.4.2. Cardiomyocyte differentiation.....	88
4. Molecular studies.....	91
4.1. <i>SCN5A</i> sequencing.....	91
4.1.1. Genomic DNA extraction	91
4.1.2. Amplification, purification and sequencing.....	91
4.2. Genetic panel associated to arrhythmogenic diseases	93
4.3. <i>SCN5A</i> mRNA expression	94
4.3.1. RNA extraction	94
4.3.2. Retrotranscription.....	96
4.3.3. qPCR	96
4.4. <i>SCN5A</i> protein expression.....	97
4.4.1. Western blot	97
4.4.2. Cell surface protein biotinylation.....	99
5. Functional studies	100
5.1. Sodium current recordings	100
5.2. Data analysis	101
6. Statistical analyses	101
V. Results	105
Study 1: <i>SCN1B</i> variant associated with concomitant brain and cardiac disorders	105

1. Nav _v 1.5 current properties are modified by β1 ^{WT} and β1b ^{WT} subunits	105
2. The mutant β1 ^{D103V} subunit decreases Nav _v 1.5 sodium current density.....	108
3. The mutant β1b ^{D103V} isoform does not modify Nav _v 1.5 properties.....	112
4. The β1 and β1b subunits modulate Nav _v 1.1 sodium current properties.....	113
5. The β1 ^{D103V} subunit decreases Nav _v 1.1 current density.....	116
6. Mutant β1 isoform b (β1b ^{D103V}) modifies Nav _v 1.1 properties.....	118
Study 2: <i>SCN5A</i> variant associated with Brugada Syndrome	121
1. Characterization of the SNV <i>SCN5A_c.4573G>A</i> in HEK-293T cells.....	122
2. Generation of iPS cell lines.....	126
2.1. Clone selection	127
2.2. Clone characterization	130
3. iPS cell differentiation to cardiomyocytes	133
3.1. Optimization of the differentiation protocol.....	133
3.2. Cardiomyocyte characterization	134
4. Electrophysiological characterization of iPS-CM	135
4.1. Evaluation of individual Rb20237 as a suitable control.....	135
4.2. Sodium current density is decreased in Rb20234 and Rb20235 individuals	137
4.3. Voltage dependence of activation and steady-state inactivation are positively shifted in Rb20234 and Rb20235 iPS-CM	142
4.4. Recovery from Inactivation is only affected in Rb20234 iPS-CM	144
4.5. The relative expression of <i>SCN5A</i> is not decreased in Rb20234 and Rb20235 iPS-CM.....	146
5. Study of the genetic background with a panel of genes related to cardiac arrhythmias.....	147
VI. Discussion	151
Study 1: <i>SCN1B</i> variant associated with concomitant brain and cardiac disorders	151
1. The SNV <i>SCN1B_c.308A>T</i> alters the regulatory properties of the β1 and β1b subunits over Nav _v 1.5 and Nav _v 1.1 channels	151
1.1. β1 ^{D103V} but not β1b ^{D103V} produces a loss of function of the cardiac sodium current.....	152
1.2. Effect of β1 ^{D103V} and β1b ^{D103V} on Nav _v 1.1 properties could impair normal neuronal activity	153
2. The clinical manifestation of the β1 and β1b subunit SNV is aggravated by the presence of other patient-specific mutations	154
Study 2: <i>SCN5A</i> variant associated with Brugada Syndrome	156

1. The SNV *SCN5A_c.4573G>A* modifies the sodium current properties of the $Na_v1.5$ channel.....156

2. The effect of the SNV on the sodium current properties of the $Na_v1.5$ channel is different in the three carrier individuals of the same family157

3. The effect of the SNV on the $Na_v1.5$ current in the iPS-CM derived from carrier individuals of the same family is different to the effect observed in HEK-293T cells heterologously expressing the SNV160

4. The three carrier individuals of the same family hold other variants that could influence the cellular phenotypical effect of the SNV161

Overall discussion..... 165

VII. Conclusions 169

VIII. Bibliography..... 173

Annex..... 189

Figures

Figure 1. The first SDS-polyacrylamide gel illustrating α and β 1 subunits.	20
Figure 2. Dendrogram of Nav channels family.....	21
Figure 3. Topology of the human VGSC α subunit.....	21
Figure 4. Top view of a VGSC.	22
Figure 5. Schematic representation of β (blue) and β 1b (grey) subunits.....	23
Figure 6. Diagram model of the sodium channel conformations proposed by Vandenberg and Bezanilla.	25
Figure 7. Conformational transitions of Nav channels.....	26
Figure 8. Study of the biophysical properties of voltage-gated sodium channels using the whole-cell patch clamp technique.	28
Figure 9. Voltage protocols used to study the recovery from inactivation of voltage-gated sodium channels using the whole-cell patch clamp technique.	31
Figure 10. Schematic representation of the heterologous expression system model.....	33
Figure 11. Representation of the iPS-derived neurons and cardiomyocytes models.	34
Figure 12. Schematic representation of the human heart.	37
Figure 13. The key ion channels in cardiac cells.	38
Figure 14. Schematic representation of cardiac APs.	40
Figure 15. ECG representation.....	41
Figure 16. Electrocardiogram in health and disease.....	45
Figure 17. ECG patterns in BrS.	50
Figure 18. Location of BrS mutations in Nav1.5 channel topology.....	52
Figure 19. Schematic representation of the ST segment elevation hypotheses.....	54
Figure 20. Pedigree of the family carrying the SCN1B and POLR1C SNVs.	60
Figure 21. The protein region that includes the SNV SCN1B_c.308A>T is shared by β 1 and β 1b isoforms and is highly conserved.....	62
Figure 22. Pedigree of the family carrying the SCN5A SNV..	63
Figure 23. The SNV SCN5A_c.4573G>A is located in a highly conserved region.....	65
Figure 24. Schematic representation of the optimized differentiation protocol.	89

Figure 25. Picture of the Bioanalyzer RNA chip used to assess RNA quality. 96

Figure 26. Protocols used for the electrophysiological characterization of the sodium current..
..... 100

Figure 27. Both $\beta 1^{WT}$ and $\beta 1b^{WT}$ increase $Na_v1.5$ peak I_{Na} 106

Figure 28. $\beta 1^{WT}$ and $\beta 1b^{WT}$ modulate $Na_v1.5$ sodium current properties..... 107

Figure 29. $\beta 1^{D103V}$ modifies the gating properties of $Na_v1.5$ channel. Whole cell currents were elicited by depolarizing potentials as shown in the insets. 109

Figure 30. $Na_v1.5$ protein expression is not affected by $\beta 1^{D103V}$.. 111

Figure 31. $Na_v1.5$ current properties are not modified by $\beta 1b^{D103V}$ 112

Figure 32. $\beta 1^{WT}$ and $\beta 1b^{WT}$ increase $Na_v1.1$ sodium current density.. 114

Figure 33. $\beta 1^{WT}$ and $\beta 1b^{WT}$ differently modulate $Na_v1.1$ sodium current properties. 115

Figure 34. $\beta 1^{D103V}$ significantly decreases $Na_v1.1$ I_{Na} 116

Figure 35. $Na_v1.1$ protein expression is not affected by $\beta 1^{D103V}$.. 118

Figure 36. $\beta 1b^{D103V}$ modifies the gating properties of $Na_v1.1$ channel.. 119

Figure 37. Paternal pedigree of the family carrying the *SCN5A* SNV, showing the individuals from whose we obtained skin samples. 121

Figure 38. Region of the pcDNA3.1-*SCN5A* vector harboring the SNV *SCN5A_c.4573G>A*. . 122

Figure 39. The SNV *SCN5A_c.4573G>A* decreases $Na_v1.5$ peak I_{Na} 123

Figure 40. The homozygous and heterozygous expression of *SCN5A_c.4573G>A* have different effects in $Na_v1.5$ sodium current properties. 124

Figure 41. $Na_v1.5$ protein expression was not decreased in cells transfected with the vectors carrying the SNV..... 125

Figure 42. Sequences of the *SCN5A* region harboring the SNV from the fibroblasts of the 4 family members. 126

Figure 43. The non-related control GPG1 iPSc overexpresses pluripotency transcription factors compared to the fibroblasts from the same individual.. 127

Figure 44. Bar graph of two representative selected clones, showing that they display expression levels of the pluripotency transcription factors that are similar to those of the non-related control.. 128

Figure 45. Sequencing of the *SCN5A* region harboring the SNV in iPSc selected clones. 129

Figure 46. Alkaline phosphatase staining (A) and karyotype (B) of Rb20235 C5 iPSc. 131

Figure 47. Pluripotency characterization of Rb20234 C17 iPSc clone.. 131

Figure 48. In vitro differentiation of Rb20234 C17 iPSc clone into the three germ layers..... 132

Figure 49. Schematic representation of the optimized differentiation protocol.. 134

Figure 50. iPS-CM do not express pluripotency transcription factors compared to the iPSc..
..... 134

Figure 51. iPS-CM overexpress cardiac gene markers compared to the iPSc. 135

Figure 52. The family-related and non-related controls display similar sodium current properties. Whole cell currents were elicited by depolarizing potentials as shown in the insets.
..... 136

Figure 53. More than 60% of Rb20234 and Rb20235 iPS-CM did not show recordable I_{Na} ... 138

Figure 54. Rb20234, Rb20235 and Rb20236 iPS-CM overexpress ventricular and atrial markers compared to the nodal marker..... 139

Figure 55. SNV SCN5A_c.4573G>A drastically decreases I_{Na} density in Rb20234 and Rb20235, and increases I_{Na} density in Rb20236..... 140

Figure 56. SNV SCN5A_c.4573G>A increases τ fast in Rb20234 and Rb20235..... 141

Figure 57. SNV SCN5A_c.4573G>A shifts voltage dependence of activation and steady-state inactivation in Rb20234 and Rb20235. 143

Figure 58. Recovery from inactivation time constant is only increased in Rb20234 iPS-CM. Recovery from Inactivation plots comparing Rb20237 with Rb20234 (top left), Rb20235 (top right) or Rb20236 (bottom)..... 145

Figure 59. SCN5A expression in Rb20234, Rb20235 and Rb20236 iPS-CM is not decreased, compared to Rb20237. 146

Figure 60. Intracardiac three-dimensional voltage mapping..... 155

Figure 61. Cellular models used for the study of the SNV SCN5A_c.4573G>A..... 160

Tables

Table 1. Media used for bacterial culture	73
Table 2. HEK-293T medium composition	73
Table 3. Fibroblasts medium composition	74
Table 4. 10% DMEM composition	74
Table 5. Differentiation media composition	75
Table 6. Starving media composition	75
Table 7. Maturation media composition.	75
Table 8. Digestion media composition	75
Table 9. HEK-293T cells lysis buffer composition	76
Table 10. Western Blot Buffers	76
Table 11. Reagents used in the Biotinylation assay	77
Table 12. Bath solutions used in the electrophysiological studies.	77
Table 13. Pipette solution used in the electrophysiological studies.	77
Table 14. Primers used to engineer the SNVs	82
Table 15. Mutagenesis reaction composition	82
Table 16. Mutagenesis thermal cycler profile	83
Table 17. Transfection conditions studied	85
Table 18. Vectors used for reprogramming	87
Table 19. PCR components	92
Table 20. PCR thermal cycler profile	92
Table 21. Sequence reaction components	92
Table 22. Sequence reaction profile	93
Table 23. Retrotranscription components	96
Table 24. KAPA SYBR FAST qPCR Kit components.	97
Table 25. TaqMan™ Gene Expression Assay components	97
Table 26. Biophysical parameters of HEK cells expressing Nav1.5 alone or together with $\beta 1^{WT}$ (left) or $\beta 1b^{WT}$ (right)	108
Table 27. Biophysical parameters of HEK cells expressing Nav1.5+ $\beta 1^{WT}$ or Nav1.5+ $\beta 1^{D103V}$..	110

Table 28. Biophysical parameters of HEK cells expressing Nav1.5+β1b^{WT} or Nav1.5+β1b^{D103V}.
 113

Table 29. Biophysical parameters of HEK cells expressing Nav1.1 alone or together with β1^{WT}
 or β1b^{WT}. 115

Table 30. Biophysical parameters of HEK cells expressing Nav1.1+β1^{WT} or Nav1.1+β1^{D103V} .. 117

Table 31. Biophysical parameters of HEK cells expressing Nav1.1+β1b^{WT} or Nav1.1+β1b^{D103V}.
 120

Table 32. Biophysical parameters of HEK-293T cells expressing Nav1.5^{WT}, Nav1.5^{WT/V1525M} or
 Nav1.5^{V1525M}. 124

Table 33. Expression levels of the pluripotency transcription factors obtained by relative
 quantification (Rq) of the selected clones for each individual of the family under study with
 respect to the non-related control iPSc. 128

Table 34. Summary of the results of the iPSc characterization. 130

Table 35. Biophysical parameters of both Rb20237 clones, Pooled Rb20237 and GPG1 iPSc-CM.
 137

Table 36. Sodium current density parameters of the four individuals of the family. 141

Table 37. Sodium current voltage dependence of activation and steady-state inactivation
 parameters of the four individuals of the family. 144

Table 38. Recovery from inactivation time constant of the four individuals of the family.... 145

Table 39. Rare SNVs found in the four individuals of the study. 147

Summary

Inherited arrhythmogenic diseases, also known as channelopathies, are mostly due to pathogenic mutations located in ion channels. These channelopathies affect a wide variety of organs, such as the brain and the heart. The type of mutations that are more frequently identified in patients suffering such diseases are changes of a single nucleotide (single nucleotide variants, SNVs).

Genetic analysis has been a useful tool to identify mutations in ion channels as the cause for various arrhythmogenic diseases, such as epilepsy and neurodevelopmental disorders in the brain; and Brugada Syndrome (BrS), long and short QT syndromes and catecholaminergic polymorphic ventricular tachycardia in the heart.

However, it is known that many mutations inherited within a family display incomplete penetrance and variable expressivity. The advent of the next generation sequencing techniques has allowed researchers to obtain information on the patient-specific genetic background. Later on, the possibility of generating individual-specific induced pluripotent stem cell-derived cardiomyocytes (iPS-CM), brought the advantage of studying a given mutation in a patient-specific cellular model.

With all this in mind, we proposed the central hypothesis of this thesis, which is that **the effect of sodium channel SNVs associated to inherited arrhythmogenic diseases is modulated by the individual's specific genetic background**. To assess this hypothesis, we studied two SNVs linked to inherited arrhythmogenic diseases that presented incomplete penetrance and/or variable expressivity in the families where they were identified.

The first SNV that we studied is located in the *SCN1B* gene (*SCN1B_c.308A>T*), in a region shared by the encoded $\beta 1$ and $\beta 1b$ subunits. This SNV was identified in heterozygosis in a whole-exome sequencing study of an 8-year-old male (proband), and was inherited from his father. Although both parents are asymptomatic, the clinical picture of the proband includes cardiac and neurological impairment. Furthermore, the proband's sister, who also carried the SNV, died from multi-organ failure.

Thus, we hypothesized that the SNV would alter the regulatory properties of both $\beta 1$ and $\beta 1b$ subunits over the cardiac and neuronal sodium channels ($Na_v1.5$ and $Na_v1.1$, respectively). To

address this point, we transiently transfected the SNV in HEK-293T cells, and studied the sodium current properties using the whole-cell patch clamp technique.

Both mutant $\beta 1$ and $\beta 1b$ subunits caused a loss of function of $Nav1.5$, possibly explaining the cardiac disorders observed in the proband. Our results showed that the mutant $\beta 1b$ subunit caused a gain of function of $Nav1.1$, while the mutant $\beta 1$ produced a loss of function of the channel. $\beta 1b$ is predominant in the brain during development and early life. During adulthood, the predominant isoform is $\beta 1$. Thus, both mutant isoforms could contribute to the arrhythmogenic brain activity at different stages of development. Additionally, the proband and her sister also carry two mutations in the gene *POLR1C*, inherited one from each of their progenitors. Therefore, we surmise that these mutations in *POLR1C* might be aggravating the brain condition of the proband, and could have contributed to the clinical phenotype of her sister.

The second SNV studied in this Thesis is located in the *SCN5A* gene (*SCN5A_c.4573G>A*). This SNV was identified in several carriers of a family, and had been previously identified in a BrS patient. The SNV was found in a subject (proband) diagnosed with atrial fibrillation, who displayed the typical BrS electrocardiogram (ECG) pattern when treated with flecainide. His daughter inherited the SNV, although she remains asymptomatic to date. The SNV was inherited by the proband's grandchildren, a girl and a boy. When tested for flecainide, the boy's ECG displayed the typical BrS phenotype but his sister's did not. Both children remain asymptomatic to date. However, since BrS symptoms occur typically in the adulthood, these patients could still develop symptoms in the future.

We hypothesized that the *SCN5A* SNV would modify the sodium current properties of $Nav1.5$. To assess this, we studied the effects of the SNV using the whole-cell patch clamp technique in two cellular models: HEK-293T cells transiently transfected with the SNV, and iPS-CM derived from a family unit of four members, three of which are carriers of the SNV: the mother (daughter of the proband), her children (grandchildren of the proband) and their father (non-carrier of the SNV).

The SNV caused a loss of function of $Nav1.5$ when it was heterologously expressed in HEK-293T cells. The study of the iPS-CM derived from the children also showed a loss of function of the sodium channel, but the magnitude of the effect was greater in this cellular model. This loss of sodium current function effect was not observed in the iPS-CM derived from the mother. Thus,

our results support the second hypothesis of this study where we proposed that the effect would be different in the three carrier individuals.

In our third hypothesis, we proposed that effect of the SNV on the Nav1.5 current in the iPS-CM derived from carrier individuals of the same family would be different to the effect observed in HEK-293T cells heterologously expressing the SNV. Our results support this hypothesis. We interpret that these differences are due to the cardiac tissue specificity that iPS-CM provide. This means that other molecules interacting with the α subunit can modify the effect of the SNV in this cellular context. Furthermore, the loss of function greater than 50% that we observed in the iPS-CM derived from the children can be explained by a dominant negative effect of the mutant α over the wild type α subunit.

We observed huge differences in sodium current properties between the mother's and the children's derived iPS-CM. As stated in our fourth hypothesis, patient-specific variants, other than the studied one, could influence both the cellular phenotypical effect of the SNV and the individual clinical features. To investigate this possibility, we performed a genetic panel customized for genes related to cardiac arrhythmias. We identified a common polymorphism carried only by the mother (leading to Nav1.5_p.H558R), which had been reported as a protective factor for other sodium channel mutations. Thus, it could explain the lack of the deleterious effect of the SNV in the mother. Other variants identified in the panel could give light to the differences observed in the flecainide test in both children. The boy has variants in the genes *MYBPC3*, *MYH6*, *MYH7* and *TNNI3*, which could be compromising the heart conductivity or the junction between cardiomyocytes, thus affecting the observed response to flecainide. The girl is a carrier of an SNV in *CACNB2*, which could be suppressing the BrS ECG.

Overall, the evidence presented in the two studies of this Thesis supports that incomplete penetrance and variable expressivity, observed within families carrying a disease-causing mutation, are highly subject to modulation by patient-specific variants. Therefore, the pathogenicity of a mutation in a family should be addressed by assessing the presence of other variants that could modulate its phenotypical expression.

Resum

Les malalties aritmogèniques hereditàries, també conegudes com a canalopaties, es donen principalment per mutacions patogèniques situades als canals iònics. Aquestes canalopaties afecten a diversos òrgans, com per exemple el cervell i el cor. El tipus de mutació identificat més freqüentment en pacients que pateixen aquestes malalties són els canvis en un sol nucleòtid (SNV, de l'anglès *single nucleotide variant*).

L'anàlisi genètic ha sigut una eina molt útil per identificar mutacions a canals iònics com a causa de vàries malalties aritmogèniques, com els trastorns del neurodesenvolupament i l'epilèpsia al cervell; i la Síndrome de Brugada (BrS), els síndromes de QT llarg i curt, i la taquicàrdia ventricular polimòrfica catecolaminèrgica al cor.

No obstant, moltes de les mutacions familiars presenten penetrància incompleta i expressivitat variable. L'advent de tècniques de seqüenciació de nova generació ha permès als investigadors obtenir informació del *background* genètic específic del pacient. A més, la possibilitat de generar cardiomiòcits derivats de cèl·lules mare induïdes pluripotents específiques d'un individu (iPS-CM, de l'anglès *induced pluripotent stem cell-derived cardiomyocytes*), ha proporcionat l'avantatge d'estudiar una mutació en un model cel·lular específic del pacient.

Amb tot això en ment, vam proposar la hipòtesi central d'aquesta Tesi, que **l'efecte d'una SNV al canal de sodi associada a una malaltia aritmogènica hereditària és modulada pel *background* genètic específic del pacient**. Per avaluar aquesta hipòtesi, vam estudiar dues SNV relacionades amb malalties aritmogèniques hereditàries que presentaven penetrància incompleta i/o expressivitat variable en les famílies on van ser identificades.

La primera SNV que vam estudiar està localitzada al gen *SCN1B* (*SCN1B_c.308A>T*), en una regió comuna entre les subunitats $\beta 1$ i $\beta 1b$ codificades per aquest gen. Aquesta SNV va ser identificada en heterozigosi en un estudi de seqüenciació d'exoma complet en un nen de 8 anys (proband), i l'havia heretada del seu pare. Encara que els seus dos progenitors son asimptomàtics, la imatge clínica del proband inclou deteriorament cardíac i neuronal. A més, la germana del proband, que també era portadora de la SNV, va morir d'una fallada multi-orgànica.

Així doncs, vam hipotetitzar que la SNV alteraria les propietats reguladores de les subunitats $\beta 1$ i $\beta 1b$ sobre els canals de sodi cardíac i neuronal ($Na_v1.5$ i $Na_v1.1$, respectivament). Per avaluar-ho, vam transfectar transitòriament el gen *SCN1B* amb la SNV en cèl·lules HEK-293T, i vam estudiar les propietats del canal de sodi mitjançant la tècnica *whole-cell patch clamp*.

Ambdues subunitats $\beta 1$ i $\beta 1b$ mutades van causar una pèrdua de funció de $Na_v1.5$, el qual podria explicar els trastorns cardíacs observats en el proband. Els nostres resultats mostren que la subunitat $\beta 1b$ mutada va causar un guany de funció de $Na_v1.1$, mentre que la $\beta 1$ mutant va produir una pèrdua de funció del canal. La subunitat $\beta 1b$ és predominant al cervell durant el seu desenvolupament i als primers anys de vida. A l'edat adulta, la isoforma predominant és $\beta 1$. Així doncs, ambdues isoformes mutants podrien contribuir a l'activitat aritmogènica del cervell a diferents etapes del desenvolupament. Addicionalment, el proband i la seva germana també eren portadors de dues mutacions al gen *POLR1C*, heretades una de cadascun dels seus progenitors. Per tant, proposem que aquestes mutacions a *POLR1C* poden estar agreujant el trastorn al cervell del proband, i podrien haver contribuït al fenotip clínic de la seva germana.

La segona SNV estudiada en aquesta Tesi està localitzada al gen *SCN5A* (*SCN5A_c.4573G>A*). Aquesta SNV va ser identificada en varis membres d'una família, i havia sigut prèviament descrita en un pacient de BrS. La SNV va ser trobada en un individu (proband) diagnosticat amb fibril·lació auricular, que mostrava el patró comú de BrS a l'electrocardiograma (ECG) quan era tractat amb flecainida. La seva filla va heretar la SNV, però fins a data d'avui és asimptomàtica. La SNV va ser heretada pels nets del proband, una noia i un noi. Ambdós nens fins a data d'avui són asimptomàtics. De totes maneres, donat que els símptomes de la BrS ocorren sobretot en l'edat adulta, aquests pacients encara podrien desenvolupar símptomes en un futur.

Vam hipotetitzar que la SNV a *SCN5A* modificaria les propietats de la corrent de sodi de $Na_v1.5$. Per avaluar-ho, vam estudiar els efectes de la SNV mitjançant la tècnica *whole-cell patch clamp* en dos models cel·lulars: cèl·lules HEK-293T transfectades transitòriament amb el gen *SCN1B* mutat, i en iPS-CM derivats de la unitat familiar formada per quatre membres, tres dels quals són portadors de la SNV: la mare (filla del proband), els seus dos fills (nets del proband) i el seu pare (no portador de la SNV).

La SNV va causar una pèrdua de funció de $Na_v1.5$ quan es trobava expressada heteròlogament en les cèl·lules HEK-293T. L'estudi dels iPS-CM derivats dels nens també va mostrar aquesta pèrdua de funció del canal de sodi, però la magnitud de l'efecte va resultar major en aquest

model cel·lular. Aquesta pèrdua de funció del canal de sodi no es va observar en els iPS-CM derivats de la mare. Així doncs, els nostres resultats recolzen la segona hipòtesi d'aquest estudi, on vam proposar que l'efecte seria diferent en els tres individus portadors.

A la nostra tercera hipòtesi, vam proposar que l'efecte de la SNV a la corrent de $Na_v1.5$ en els iPS-CM derivats dels portadors de la mateixa família seria diferent a l'efecte observat a les cèl·lules HEK-293T expressant la SNV heteròlogament. Els nostres resultats recolzen aquesta hipòtesi. Interpretem que aquestes diferències són causades per l'especificitat de teixit cardíac que proporcionen els iPS-CM. Això significa que altres molècules que interactuen amb la subunitat α poden modificar l'efecte de la SNV en aquest context cel·lular. A més, la pèrdua de funció major a 50% observada en els iPS-CM derivats dels nens es pot explicar per un efecte dominant negatiu de la α mutada sobre la subunitat α *wild type* del canal.

Vam observar grans diferències en les propietats de la corrent de sodi entre els iPS-CM derivats de la mare i dels seus fills. Tal i com proposa la nostra quarta hipòtesi, variants específiques de pacient, diferents a l'estudiada, podrien influenciar tant l'efecte fenotípic de la SNV com les propietats clíniques de l'individu. Per investigar aquesta possibilitat, vam realitzar un panell genètic perquè incloïa gens relacionats amb arítmies cardíques. Vam identificar un polimorfisme comú del qual només la mare n'era portadora (i que dóna lloc a la proteïna $Na_v1.5_p.H558R$), el qual ha estat reportat com un factor protector per altres mutacions al canal de sodi. Així doncs, podria explicar la falta de l'efecte perjudicial de la SNV a la mare. Altres variants identificades amb el panell poden donar llum a les diferències observades en el test de flecainida dels dos nens. El noi és portador de variants als gens *MYBPC3*, *MYH6*, *MYH7* i *TNNI3*, que podrien comprometre la conductivitat cardíaca o la unió entre els cardiomiòcits, afectant així la resposta observada a la flecainida. La noia és portadora d'una SNV al gen *CACNB2*, que podria suprimir l'ECG de BrS.

En general, la evidència presentada en els dos estudis d'aquesta Tesi recolza que la penetrància incompleta i l'expressivitat variable, observades en famílies portadores d'una mutació causant d'una malaltia, es troben influenciades pels efectes moduladors de variants específiques de pacient. Per tant, la patogenicitat d'una mutació en una família hauria de ser abordada avaluant la presència d'altres variants que podrien modular la seva expressió fenotípica.

Resumen

Las enfermedades arritmogénicas hereditarias, también conocidas como canalopatías, se deben principalmente a mutaciones patogénicas situadas en los canales iónicos. Estas canalopatías afectan a diferentes órganos, como por ejemplo el cerebro y el corazón. El tipo de mutación identificado más frecuentemente en pacientes que sufren estas enfermedades son los cambios en un solo nucleótido (SNV, del inglés *single nucleotide variant*).

El análisis genético es una herramienta muy útil para identificar la asociación de las mutaciones en canales iónicos como causa de un gran número de enfermedades arritmogénicas (e.g: epilepsia y trastornos del neurodesarrollo en el cerebro; Síndrome de Brugada (BrS), síndromes de QT largo y corto, y taquicardia ventricular polimórfica catecolaminérgica en el corazón).

No obstante, muchas de las mutaciones familiares presentan penetrancia incompleta y expresividad variable. El advenimiento de técnicas de secuenciación masiva de nueva generación ha permitido a los investigadores obtener información del acervo genético específico del paciente. Además, la posibilidad de generar cardiomiocitos derivados de células pluripotentes inducidas específicas de un individuo (iPS-CM, del inglés *induced pluripotent stem cell-derived cardiomyocytes*), ha proporcionado la ventaja de estudiar los efectos de una mutación dada en un modelo celular específico del paciente.

En base a esto, propusimos la hipótesis central de esta Tesis: **el efecto de una SNV en el canal de sodio asociada a una enfermedad arritmogénica hereditaria se encuentra modulada por el acervo genético específico del paciente**. Para evaluar esta hipótesis, estudiamos dos SNV relacionadas con enfermedades arritmogénicas hereditarias que presentaban penetrancia incompleta y/o expresividad variable en las familias donde fueron identificadas.

La primera SNV que estudiamos se encuentra localizada en el gen *SCN1B* (*SCN1B_c.308A>T*), en una región común entre las subunidades $\beta 1$ y $\beta 1b$ codificadas por este gen. Esta SNV se encuentra en heterocigosis y fue identificada en un estudio de secuenciación de exoma completo en un niño de 8 años (probando), quien la había heredado de su padre. Mientras que los padres son asintomáticos, la imagen clínica del probando incluye un deterioro cardíaco y

neuronal. Además, la hermana del probando, también portadora de la SNV, murió de un fallo multiorgánico.

Así pues, hipotetizamos que la SNV altera las propiedades reguladoras de las subunidades $\beta 1$ y $\beta 1b$ sobre los canales de sodio cardíaco y neuronal ($Na_v1.5$ y $Na_v1.1$, respectivamente). Para evaluarlo, transfectamos transitoriamente la SNV en células HEK-293T, y estudiamos las propiedades del canal de sodio usando la técnica *whole-cell patch clamp*.

Ambas subunidades $\beta 1$ y $\beta 1b$ mutadas causaron una pérdida de función del canal $Na_v1.5$, posiblemente explicando los trastornos cardíacos observados en el probando. Nuestros resultados muestran que la subunidad $\beta 1b$ mutada causó una ganancia de función del canal $Na_v1.1$, mientras que la subunidad $\beta 1$ mutada produjo una pérdida de función de este canal. La subunidad $\beta 1b$ es predominante en el cerebro durante su desarrollo y en los primeros años de vida. En la edad adulta, la isoforma predominante es la $\beta 1$. Así pues, ambas isoformas mutadas podrían contribuir a la actividad arritmogénica del cerebro en diferentes etapas de su desarrollo. Adicionalmente, el probando y su hermana también eran portadores de dos mutaciones en el gen *POLR1C*, heredadas de cada uno de sus progenitores. Por lo tanto, proponemos que estas mutaciones en *POLR1C* podrían estar agravando el trastorno en el cerebro del probando, y podrían haber contribuido en el fenotipo clínico de su hermana.

La segunda SNV estudiada en esta Tesis está localizada en el gen *SCN5A* (*SCN5A_c.4573G>A*). Esta SNV fue identificada en varios miembros de una familia, y había sido previamente identificada en un paciente de BrS no relacionado con esta familia. La SNV se encontró en un individuo (probando) diagnosticado con fibrilación auricular, que mostraba un patrón común de BrS en el electrocardiograma (ECG) cuando fue tratado con flecainida. Su hija heredó la SNV, aunque a día de hoy es asintomática. La SNV fue heredada por los nietos del probando, una chica y un chico. Ambos niños hasta ahora son asintomáticos. No obstante, dado que los síntomas del BrS ocurren sobre todo en la edad adulta, estos pacientes podrían aún desarrollar síntomas en un futuro.

Nuestra hipótesis era que la SNV en *SCN5A* modificaría las propiedades de la corriente de sodio del canal $Na_v1.5$. Para evaluar esto, estudiamos los efectos de la SNV mediante la técnica *whole-cell patch clamp* en dos modelos celulares: células HEK-293T transfectadas transitoriamente con la SNV, y en iPS-CM derivados de cuatro miembros de la familia, tres de los cuales son portadores

de la SNV: la madre (hija del probando), sus dos hijos (nietos del probando) y su padre (no portador de la SNV).

La SNV causó una pérdida de función del canal Nav1.5 en el modelo de expresión heteróloga en las células HEK-293T. El estudio de los iPS-CM derivados de los niños también mostró esta pérdida de función del canal de sodio, pero la magnitud del efecto fue mayor en este modelo celular. Esta pérdida de función del canal de sodio no se observó en los iPS-CM derivados de la madre. Así pues, nuestros resultados apoyan la segunda hipótesis de este estudio, en la cual propusimos que el efecto de la SNV sería diferente en los tres individuos portadores.

En nuestra tercera hipótesis, propusimos que el efecto de la SNV en la corriente de Nav1.5 en los iPS-CM derivados de los portadores de la misma familia sería diferente al efecto observado en las células HEK-293T que expresaban la SNV heterológamente. Nuestros resultados apoyan esta hipótesis. Interpretamos que estas diferencias vienen dadas por la especificidad de tejido cardíaco que dan los iPS-CM. Esto significa que otras moléculas que interactúan con la subunidad α del canal pueden modificar el efecto de la SNV en este ambiente celular. Además, la pérdida de función mayor que 50% observada en los iPS-CM derivados de los niños podría ser explicada por un efecto dominante negativo de la α mutada sobre la subunidad α *wild type* del canal.

Observamos grandes diferencias entre las propiedades de la corriente de sodio entre los iPS-CM derivados de la madre y los niños. Tal y como se propone en la cuarta hipótesis, algunas variantes específicas de los pacientes, diferentes a la estudiada, podrían influir tanto en el efecto fenotípico de la SNV como en el cuadro clínico del individuo. Para investigar esta posibilidad, realizamos un panel genético diseñado para genes relacionados con arritmias cardíacas. Identificamos un polimorfismo común del cual solo la madre es portadora (Nav1.5_p.H558R). Este polimorfismo ha sido reportado como un factor protector en otras mutaciones en el canal de sodio cardíaco. Así pues, podría explicar la ausencia del efecto perjudicial de la SNV en la madre. Otras variantes identificadas en el panel pueden dar luz a las diferencias observadas en el test de flecainida de los dos niños. El niño es portador de variantes en los genes *MYBPC3*, *MYH6*, *MYH7* y *TNNI3*, que podrían comprometer la conducción eléctrica en el corazón o la unión entre los cardiomiocitos, afectando así la respuesta observada en el test de flecainida. La niña es portadora de una SNV en el gen *CACNB2*, que podría contrarrestar el efecto de la mutación en el canal de sodio e influir en la ausencia del patrón de BrS en el ECG.

En conjunto, la evidencia presentada en los dos estudios de esta Tesis apoya que la penetrancia incompleta y la expresividad variable, observadas en familias portadoras de una mutación causante de una enfermedad arritmogénica hereditaria, se encuentran influenciadas por la modulación de variantes específicas del paciente. Por lo tanto, la patogenicidad de una mutación en una familia debe ser evaluada teniendo en cuenta la presencia de otras variantes que podrían modular su expresión fenotípica.

I. Introduction

1. Inherited arrhythmogenic diseases or channelopathies

Ion channels are transmembrane proteins located across the lipid bilayer of cell membranes, where they form a pore to facilitate the inflow or outflow of specific ions. The passage of these ions through the pore is controlled by either the membrane potential (voltage-gated channels), extracellular ligand molecules (ligand-gated channels), or different mechanisms (such as second messengers, temperature, mechanical stimuli, or light).^{1,2}

Arrhythmogenic diseases occur when the normal rhythm of either neuronal or cardiac cells is disrupted. Inherited arrhythmogenic diseases (from now on channelopathies), are developed by alterations in ion channels activity, either due to pathogenic mutations in genes that encode the proteins that form the ion channels or by acquired factors.¹ Pathogenic mutations are the most common cause, and these mutations lead to alterations in the protein structure, function, localization and/or modulation. They can be located in the pore-forming α subunits, the β subunits and/or other regulatory proteins.^{1,3}

The type of mutations that are more frequently identified in patients suffering a channelopathy are changes of a single nucleotide (single nucleotide variant, SNV), which can result in either a different aminoacid (missense SNV) or a stop codon (nonsense SNV). Other types of variants can be identified in a lower proportion of cases. These include deletions or insertions of one or more bases (known as indels) and copy number variants, in which a DNA segment of 1kb or bigger is present in a different number of copies with respect to the reference genome. These two latter types of mutations can shift the way the sequence is read (frameshift).

Once the mutation has been identified, it can be classified, based on its frequency in the population, as: new, rare (present in <1% of the population) or as polymorphisms (>1% of the population). To determine whether the mutation can be pathogenic and thus can be the cause of the channelopathy in the patient, the following criteria points are assessed:⁴

- Cosegregation of the variant and the phenotype in a family diagnosed with a disease.
- Absence or extreme rarity of the variant in control cohorts and exome/genome datasets.
- The variant is nonsense, frameshift or insertion/deletion that leads to a truncated protein.
- The variant is missense and is located in highly conserved aminoacids or key functional domains.

- Evidence of a perturbed ion channel function through functional studies.
- In silico prediction of pathogenicity with bioinformatic tools.

Depending on how many items of the pathogenicity criteria a mutation fulfills, it can be classified as:^{5,6}

- Possibly pathogenic: can lead to a phenotypic change.
- Possibly benign or neutral: the mutation might not cause the channelopathy.
- Variant of uncertain significance: there is not enough evidence to catalogue the mutation.

Pathogenic mutations in ion channels are recognized causes of disease in a wide variety of tissues. Besides brain and heart, they have been reported in skeletal muscle, and in the respiratory, endocrine, urinary and immune systems.^{1,7,8} Furthermore, some mutations have been reported to have a concomitant effect in more than one tissue, mostly involving the brain and the heart. Evidence from animal models and human case studies suggests that genetic variants associated with cardiac arrhythmias may contribute to some cases of sudden unexpected death in epilepsy (SUDEP). It has been reported that *KCNH2* mutations can increase the risk of both long QT syndrome (LQT) and epilepsy, and are found more frequently among SUDEP patients.⁹⁻¹¹ Additionally, Tiron *et al.* suggested that a SNV in *KCNQ1* could be causing both LQT syndrome and epilepsy.¹² Haugaa *et al.* reported that 72% of their cohort of patients carrying a LQT-associated mutation displayed electroencephalogram abnormalities.¹³ Andersen-Tawil syndrome, also known as LQT7, is a rare channelopathy with a wide variety of symptoms, including episodic muscle weakness, cardiac arrhythmias and dysmorphic features.¹⁴ Additionally, a SNV in the *SCN5A* gene was reported to cause both Brugada Syndrome (BrS) and epilepsy.¹⁵

In this Thesis, we studied two SNVs affecting the sodium current. One of these mutations was identified in a patient with concomitant brain and heart diseases. The other SNV is related to BrS, a cardiac channelopathy. Although the main focus of this Thesis was on cardiac diseases, brain-associated channelopathies will be briefly explained in the following section. Channelopathies affecting the heart will be further discussed in **section 5.3**.

1.1. Neurological channelopathies

Ion channels are fundamental in the neuronal signaling processes, and different types of ion channels have been identified in neuron's membranes. The voltage-gated sodium channels predominantly expressed in brain are Nav1.1, Nav1.2 and Nav1.6 (encoded by the *SCN1A*, *SCN2A* and *SCN8A* genes, respectively). Other identified channels in neurons include potassium channels (voltage-gated and calcium-activated, among others), calcium channels (high- and low-voltage activated) and voltage-gated channels permeable to potassium and sodium ions (*HCN* channels). Other channels located in neuron's cell membrane are ion pumps and ligand-gated channels.²

Neurological channelopathies can compromise neurons, thus affecting the generation and spread of the action potential (AP) or suppressing it. The membrane excitability impairment may lead to a diversity of symptoms, including seizures, paralysis, ataxia or extreme pain.^{1,2,16} Neurological channelopathies have been described to be caused by mutations in the genes encoding for the previously mentioned ion channels and the sodium channel regulatory β 1 subunit (*SCN1B*).^{2,17,26,18–25}

The more prevalent channelopathies include several types of epilepsy, neurodevelopmental and psychiatric disorders, and hemiplegic migraine among others.^{1,20,21,23,26} Mutations in *SCN1A* have been principally linked to Dravet Syndrome (DS), a severe type of epilepsy, and to generalized epilepsy with febrile seizures plus (GEFS+).²⁷ These mutations mostly cause a loss of function of the channel, but a few cases present either a gain of function or a mixed modulation.^{28–30} A few mutations linked to DS and GEFS+ have been found in *SCN1B*, and have been described to cause a loss of function of the channel with which it was co-transfected.^{28,31–35}

1.2. Incomplete penetrance and variable expressivity

It is widely accepted that many channelopathies display incomplete penetrance and variable expressivity.³⁶ The disease penetrance is the probability that individuals that carry the same disease-causing mutation will manifest the phenotypic features of that disorder. On the other hand, variable expressivity is the type and severity of the phenotypic features observed on the genotype-positive individuals who harbor the same mutation. For example, in cardiac channelopathies, this variable expressivity ranges from electrocardiogram (ECG) abnormalities (e.g. ST segment elevation) and arrhythmias (e.g.

syncope, sudden cardiac death (SCD)), to the absence of any abnormality and a lifelong asymptomatic state.⁴ Although there's an underlying incomplete penetrance with genetic and phenotypical variability in channelopathies that still remains unknown,³⁶ the fact that the variability may be observed even among members of the same family³⁷ suggests that other genetic and environmental factors can influence the phenotype.³⁸

1.2.1. Genetic factors

Some studies have focused on the co-inheritance of functional mutations, which can influence the phenotype, either by enhancing or repressing the effects of the potentially pathogenic mutation (compound mutations). These mutations can reside on the same or opposite allele of the affected gene, or in a completely different gene, thus acting in the gene transcriptional regulation, its splicing or affecting post-translational modifications composition. Variants in non-coding regions responsible for regulating channelopathy-susceptible genes may also function as genetic modifiers.^{4,37}

Since ion channels do not function in isolation, mutations in any interacting protein could modulate the effect of a given mutation.³⁷ In the study by Gourraud *et al.*, in which they identified three loci associated with BrS susceptibility, it was shown that the cumulative effect on disease susceptibility was large. This demonstrated that the presence of different genetic polymorphisms can influence BrS phenotype.³⁶ Furthermore, several polymorphisms have been described in the *SCN5A* promoter. For example, Van den Boogaard *et al.* demonstrated that an *SCN10A* haplotype was an enhancer region for *SCN5A*.³⁹ Additionally, they verified that a variant in this locus alters a transcription factor binding site, which reduces *SCN5A* expression.⁴⁰ This haplotype has been linked to a reduced I_{Na} in the presence of a potentially pathogenic mutation.⁴¹

Fernández-Marmiesse *et al.* proposed that the incomplete penetrance in brain diseases can be explained by the Knudson 2-hit mechanism. This mechanism suggests that an individual can inherit one variant from one progenitor, and a subsequent appearance of a second variant in the same gene or another can have an accumulative effect to the phenotype. Thus, the co-occurrence of two mutations that are independently innocuous can give rise to a clinical phenotype.⁴²

1.2.2. Environmental factors

The predominant environmental factor affecting the phenotype is temperature. Higher temperatures have been shown to accentuate premature $\text{Na}_v1.5$ inactivation. Thus, febrile states may increase the risk of an arrhythmogenic event, particularly in the pediatric individuals.^{43,44} In epilepsies such as DS, the temperature has also been demonstrated to increase the risk of seizures.^{45,46} Another environmental factor are medications such as antidepressants, antiarrhythmics and anesthetics. Taking these drugs has been associated with higher risk of ST segment elevation and arrhythmias in those individuals genetically predisposed.^{43,47}

The focus of this Thesis are two different SNVs affecting the cardiac- and brain-type sodium currents. Thus, the following chapter summarizes the main characteristics of voltage-gated sodium channels (VGSC), and the properties of the currents that flow through them.

2. Voltage-gated sodium channels

Voltage-gated sodium (Na_V) channels are ion channels with selective permeability to Na^+ ions, allowing them to flow following their electrochemical gradient. Na_V channels have a determinant role in the electrical activity of many cells, as they initiate APs in excitable cells.^{48,49} They were first identified in 1952 by Hodgkin and Huxley, in their work studying the electric conductance in axons of giant squids.⁵⁰

In 1980, Beneski and Catterall's biochemical experiments led to the discovery of the sodium channel protein. They identified the principal α subunit and the auxiliary $\beta 1$ subunit of brain sodium channels (**Figure 1**).⁵¹

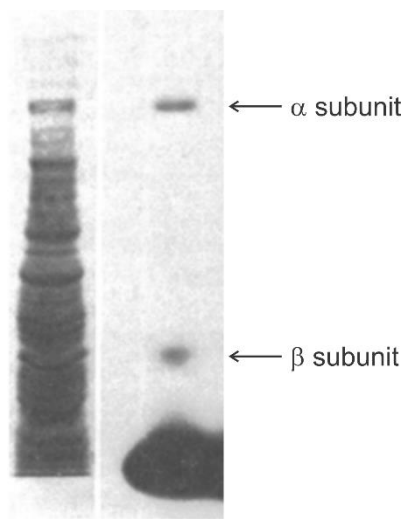

Figure 1. The first SDS-polyacrylamide gel illustrating α and $\beta 1$ subunits. On the left is the molecular weight marker. On the right α and $\beta 1$ subunits covalently labeled with ^{125}I -Sctx in standard binding medium containing $1 \mu\text{M}$ tetrodotoxin. Adapted from Beneski and Catterall.⁵¹

2.1. Genes, molecular structure and function of α subunits

Na_V channels are composed of a single α subunit and one or two β subunits.⁵² The principal subunit of Na_V channels is the α , it is large and accounts for all the defining properties of Na_V channels.⁵³ So far ten genes of about 8000 bp, encoding for different Na_V α subunit subtypes, have been identified.⁵⁴ Each of these genes is supposed to have arisen by a gene duplication followed by an evolutionary process to create a new specialized subtype. They are classified as *SCN1A* through *SCN11A*, and encode for the corresponding proteins $\text{Na}_V 1.1$ through $\text{Na}_V 1.9$. The resulting proteins contain around 2000 amino acids and have a molecular weight of about 260 kDa.⁵⁴ The different subtypes are represented in the dendrogram depicted in **Figure 2**, according to their aminoacid similarity.⁵³

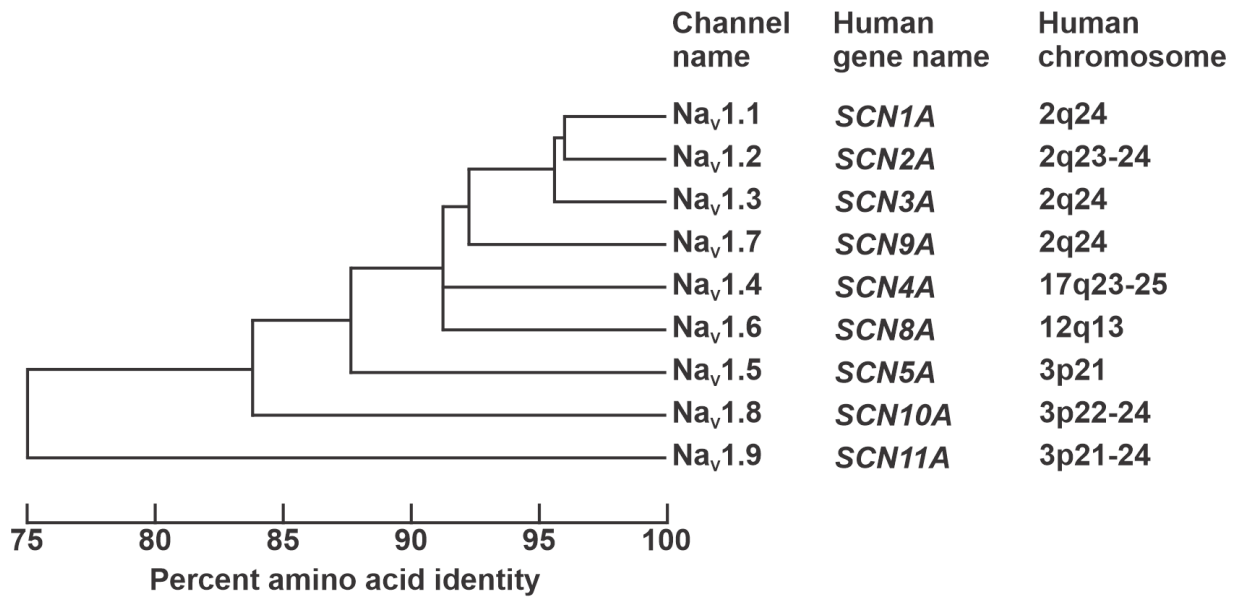

Figure 2. Dendrogram of Na_v channels family. Adapted from Hille.⁵³

Figure 3 depicts the α subunit structure. It is organized into four homologous but non-identical domains (denoted I to IV) of 300 to 400 amino acids.^{53,54} Each domain consists of six α-helix transmembrane segments (S1 to S6), connected by linker segments.

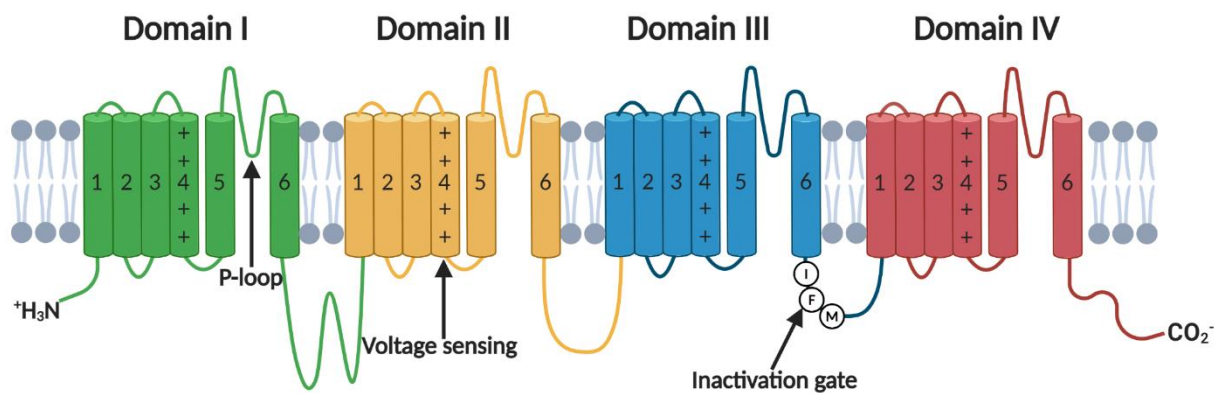

Figure 3. Topology of the human VGSC α subunit. Created with BioRender.com.

The S4 segment from each domain form the voltage-sensing domain (VSD), that regulates the channel opening upon depolarization of the membrane and triggers the pore opening. This segment includes four positively charged aminoacids at every third residue, carrying much of the gating charge of the VSD. Upon depolarization, the S4 segments move toward the extracellular surface. Even though S4 is the principal voltage sensor, S1-S3 enable the movement of VSD, allowing its exposure to the two sides of the membrane.⁵³⁻⁵⁵

The four VSDs fold around a central aqueous ion-conducting pore or pore domain (PD) (**Figure 4**), which is lined by the S5-S6 loop (known as P-loop).^{56,57} This loop determines the ion selectivity and conductance properties of Nav channels.⁵⁸

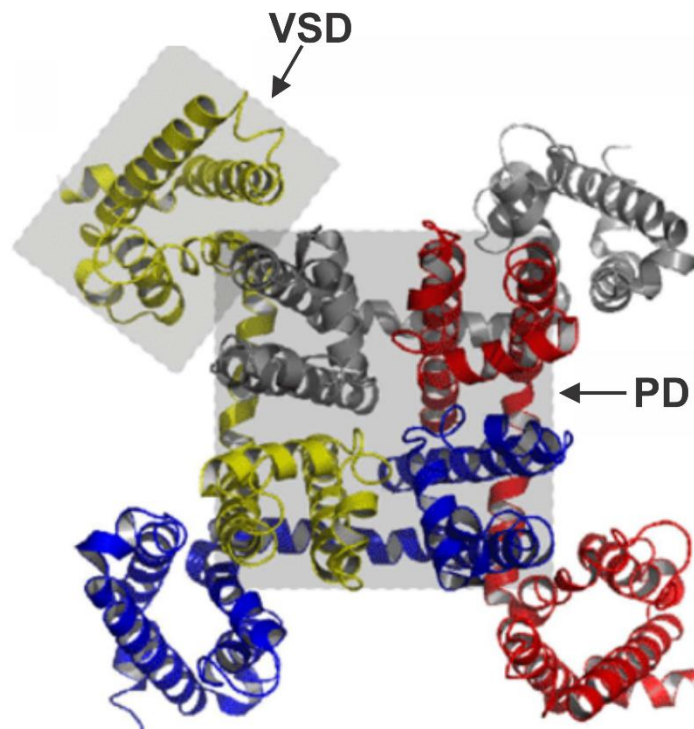

Figure 4. Top view of a VGSC. The channel consists of four homologous domains (DI-DIV), colored in yellow, grey, red and blue. The S4 segment of each domain forms the VSD, which folds around the PD. Adapted from Vetter *et al.*⁵⁹

The fast inactivation of the channel is possible thanks to a short and highly conserved intracellular loop that connects domains III and IV, known as the inactivation gate.^{55,57} This segment protrudes intracellularly and, upon membrane depolarization, it moves blocking the channel pore.⁵⁴

2.2. Genes, molecular structure and function of β subunits

Nav channels are also composed of β subunits, which are referred to as auxiliary or regulatory.⁵³ These β subunits are small non-pore-forming proteins of 30 to 40 kDa, members of the immunoglobulin (Ig) superfamily of cell adhesion molecules (CAM).⁵⁴ To date, four genes encoding for β subunits have been identified: *SCN1B*, *SCN2B*, *SCN3B* and *SCN4B*. They encode for the proteins $\beta 1$ and its splice variant $\beta 1b$, $\beta 2$, $\beta 3$ and $\beta 4$, respectively.^{54,60} All five β subunits contain an extracellular Ig domain. With the exception of

β 1b, β subunits consist of a single polypeptide chain with an extracellular N-terminus domain, a transmembrane segment, and an intracellular C-terminus domain. β 1b has an in-frame retention of intron 3, from which it generates an alternate C-terminus sequence that does not include a transmembrane domain (**Figure 5**).^{61,62} Thus, β 1b is expressed as a soluble molecule.⁶³ Subunits β 1 and β 3 associate noncovalently to the α subunit, whereas β 2 and β 4 bind covalently.⁵⁵

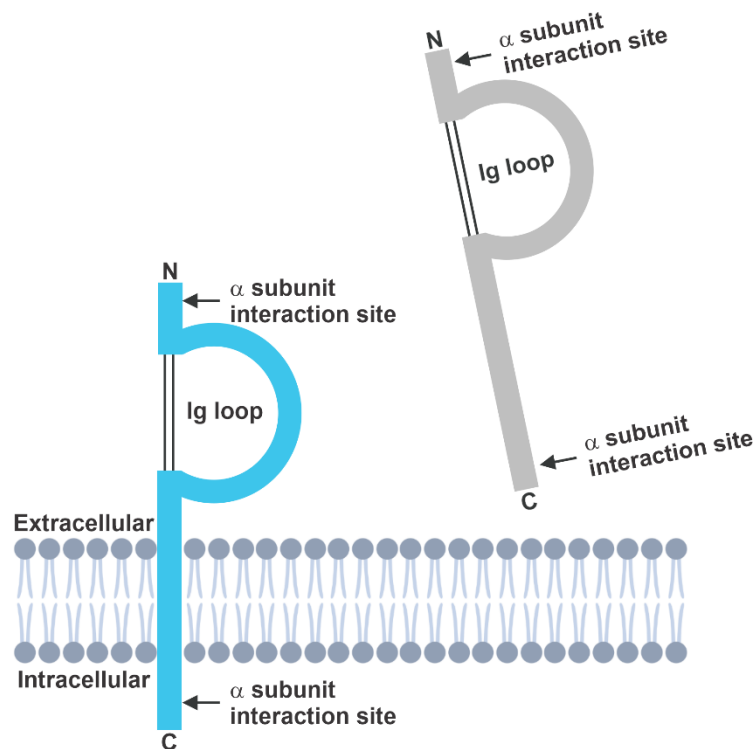

Figure 5. Schematic representation of β (blue) and β 1b (grey) subunits. Parallel vertical lines correspond to the protein disulfide bonds. Own creation.

Although the α subunit expression is sufficient to reconstitute functional Nav channels in heterologous expression systems, β subunits modulate their function.⁵⁴ Coexpression of the β with the α subunit augments the number of functional channels that reach the plasma membrane, changes gating rate constants and shifts the midpoint of activation and inactivation curves.⁵³ The most important functions of the β subunits are to stabilize Nav channels in the cellular membrane, and to coordinate the interactions with other anchoring proteins.^{54,64}

2.3. Biophysical properties of voltage-gated sodium channels

Na_v channels are expressed in the cell membranes of both excitable and non-excitable cells. Na_v channels can adopt conformational transitions between closed and open states in response to changes in the voltage of the membrane potential detected by the voltage sensor, also known as gating.^{49,65} These transitions involve the opening or the closing of the pore, which will either block or allow the flow of ions through it and thus the electrical current.⁵⁵ As it will be described in further detail in **chapter 4**, the gating of Na_v channels is the fundamental processes behind electrical phenomena such as the heartbeat.⁶⁵

Na_v channels have three characterizing features:^{54,57}

- A voltage-dependent activation.
- A fast inactivation.
- Selective ion channel conductance.

In the 1950's, Hodgkin and Huxley developed a method to study the currents that underlie the changes of voltage across the membrane of the giant squid axon: the voltage clamp.⁵⁰ In this technique, the voltage that flows across the cell membrane is controlled as a mean to measure the electrical current that results from the flow of ions through the ion channels.^{49,66} Three decades later, after the proposal of the modern membrane model, Hamill *et al.* developed the patch clamp technique. This technique used the principles of the voltage clamp, but allowed the recording of current across a small patch of the membrane as first reported by Neher and Sakmann.^{67,68} Hamill *et al.* accomplished the creation of a high resistance seal between glass pipettes and the cell membrane, known as gigaseal.⁶⁷ The patch clamp technique has four main configurations that allow to study different channel properties. Among these, the whole-cell recording configuration allows to study of whole cell ion currents that flow through the cellular membrane, by creating access to the intracellular media after rupturing the fraction of membrane sealed to the pipette.⁶⁶ This is the most used voltage clamp technique, and is the technique used to study sodium current properties in this Thesis. Further information about cellular current recordings can be found in **Annex section 1.2**.

The work of Hodgkin and Huxley in 1952 using the voltage clamp technique allowed to describe a model to determine ion fluxes and permeability changes of the excitable membranes in terms of molecular mechanisms: the HH model. Their experiments showed

that the conductance of the membrane changed gradually with time, with no large jumps. Although their model treats activation and inactivation as independent of each other, some experiments showed that both processes were interdependent.^{53,69} Later, single sodium channel analysis demonstrated that the channel could go to the inactivated state from closed states, as well as from the open state.^{70,71} These findings prompted the reformulation of the HH model, and lead to a coupled model, which postulated that the transition between closed and open states could be represented as:

$$\text{Closed} \leftrightarrow \text{Open}$$

But, since Na_v channels are not symmetrical, they do not exactly follow this model. Each repeat or domain has its own transition.⁵³ Bezanilla and Armstrong proposed in 1977 the following diagram model, that incorporates several closed ($\text{C}_1\text{-C}_4$) states, and one open (O) and one inactivated (I) state:⁷²

$$\text{C}_4 \leftrightarrow \text{C}_3 \leftrightarrow \text{C}_2 \leftrightarrow \text{C}_1 \leftrightarrow \text{O} \leftrightarrow \text{I}$$

Later, this model had several modifications and, in 1991, Vandenberg and Bezanilla introduced a new model that incorporated the knowledge on single and whole currents together with gating currents. The model incorporates several closed and inactivated states with one open state. As **Figure 6** shows, according to this model the inactivated states could be reached from a closed and/or the open states

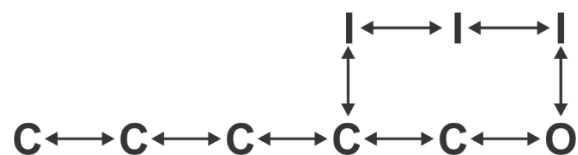

Figure 6. Diagram model of the sodium channel conformations proposed by Vandenberg and Bezanilla. Adapted from Bezanilla.⁶⁹

A simple scheme showing the transitions between channel conformations is presented in the following **Figure**:

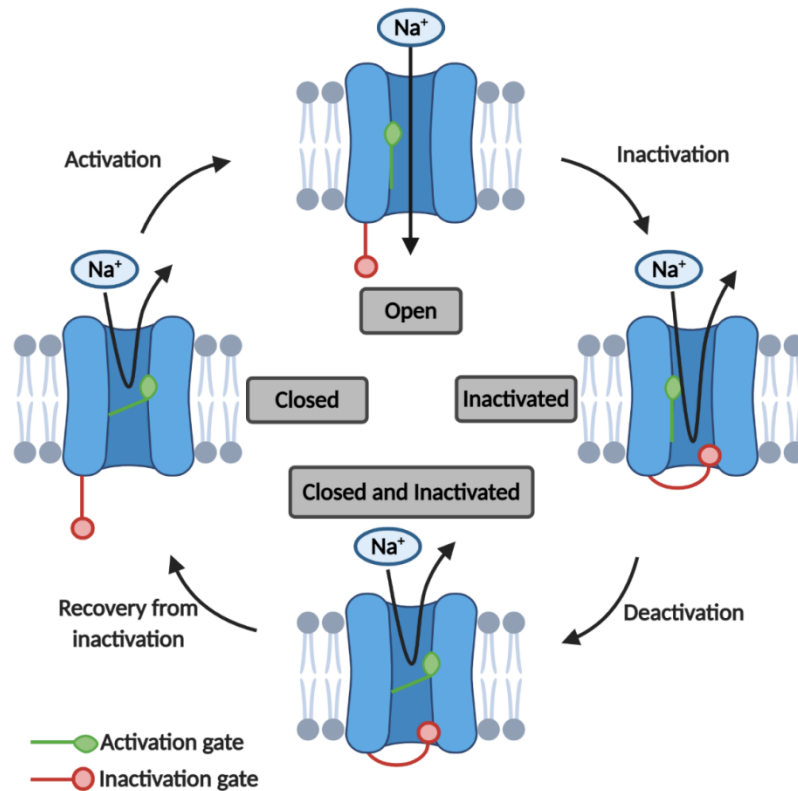

Figure 7. Conformational transitions of Na_v channels. Created with BioRender.com.

2.3.1. Closed state

The cardiac sodium channel is at a closed state at negative potentials of about -90 mV. In this conformation, the inactivation gate is open but the activation gate is closed, there is no influx of Na⁺ into the cell and therefore there is no current flow.⁶⁶

Normally, in patch clamp experiments, a holding potential of -120 mV is applied to ensure that the channels are at a closed state and available to be activated.

2.3.2. Open state

At depolarizing potentials, both the activation and inactivation gates are open and the channel allows the communication between the intracellular and extracellular compartments. Thus, ions can cross the membrane following their electrochemical gradient. The amount of time that a channel remains open varies depending on the membrane voltage (referenced as open probability), and thus the ion flux will change at different voltages.⁶⁵

Membrane conductance is a useful measure of how many channels are open in a given membrane area. Some channels present rectification, meaning that their conductance

changes with voltage. A strong rectification would mean that the ion channels are open at some membrane potentials but closed at others.⁵³

I-V relationship

The current carried by the ions varies with the membrane voltage, and is represented as the current-voltage (I-V) relationship for that ion.⁶⁶ **Figure 8A** shows typical current traces, obtained during patch clamp experiments in the whole-cell configuration in response to a series of voltage steps. At negative pulses (-80 mV in red in this example), there is no influx of I_{Na} . As the depolarization increases to -40 mV (blue), Na_v channels open and I_{Na} becomes increasingly negative (inward). At -20 mV (green) the open probability of the channel increases and thus I_{Na} is larger. As the potential reaches the sodium equilibrium potential (E_{Na}), the driving force for Na^+ decreases and thus the I_{Na} decreases also, even when channels are open. At even more positive potentials of 80 mV (black), beyond the reversal potential, I_{Na} is positive (outward). Thus, the I-V shape is given by the effect of the membrane potential on channel open probability and on the driving force.⁶⁶ The peak current at each applied voltage can be normalized by the cell capacitance, thus obtaining the I_{Na} density (**Figure 8B**).

Voltage-dependence of activation

Voltage-dependence of activation is different for each type of channel, and it refers to the response of the charged residues in S4 when the electric field across the membrane is perturbed. The relationship between channel activation and voltage can be determined from the same I-V protocol, which allows the calculation of the channel conductance (g) at each voltage from the modified Ohm's law:

$$g_{Na} = \frac{\text{Peak } I_{Na}}{V - E_{Na}}$$

where V is the membrane potential, peak I_{Na} the maximum current value and E_{Na} the Na^+ equilibrium potential. By measuring the current at each voltage, the conductance can be calculated. Then, the ratio g/g_{max} can be plotted as a function of voltage, to obtain the activation curve (**Figure 8E**).

The activation curve can be fitted by a Boltzmann equation of the form:

$$g = \frac{g_{\max}}{1 + \exp \frac{V_{1/2} - V}{k}}$$

where g_{\max} is maximum conductance, $V_{1/2}$ is the voltage at which half of the activation occurs, and k is the slope factor that determines how steeply the activation curve changes with voltage.

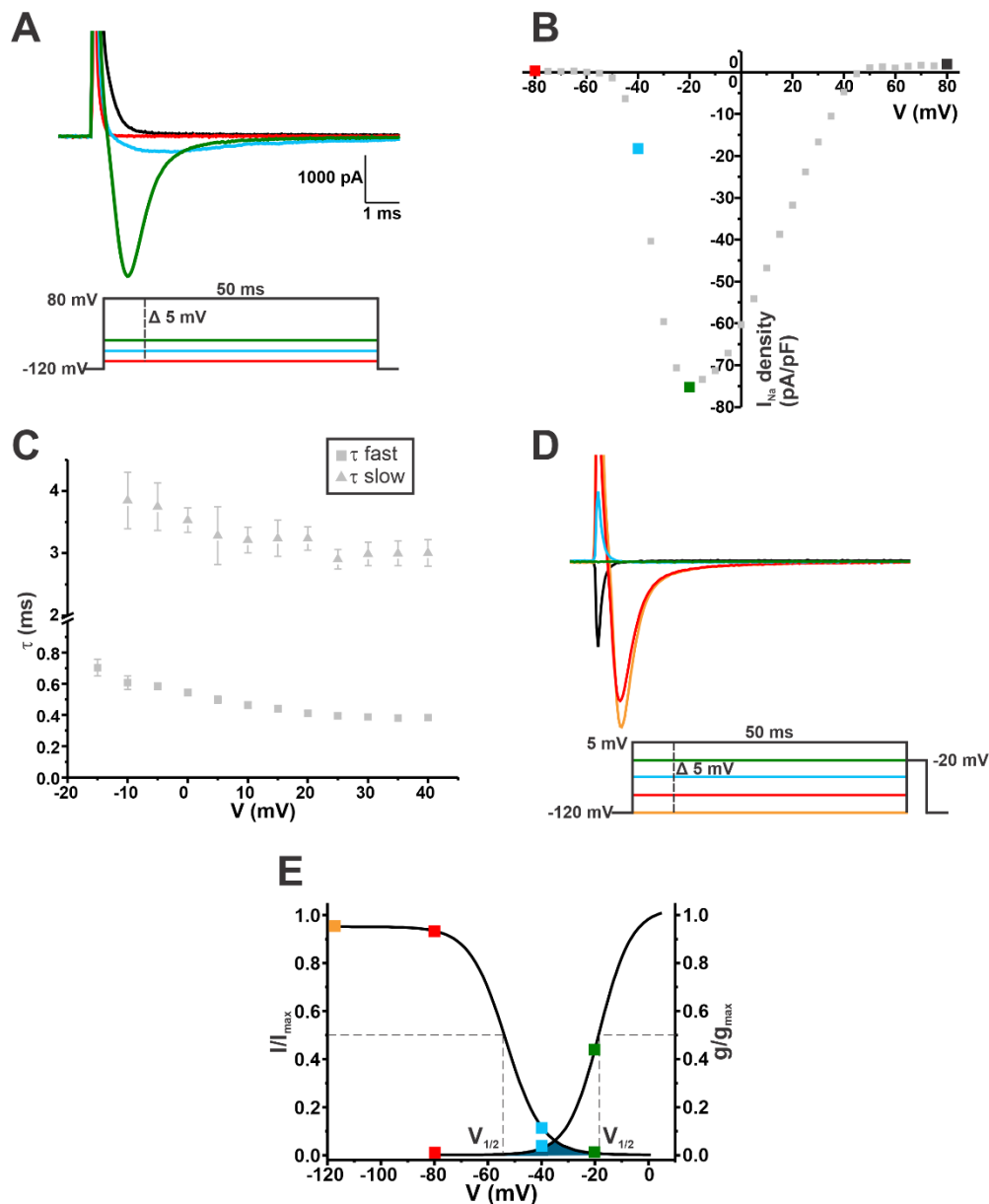

Figure 8. Study of the biophysical properties of voltage-gated sodium channels using the whole-cell patch clamp technique. (A) Macroscopic current traces obtained after depolarizing pulses of 50 ms with a 5 mV increment. The red line represents the current obtained at -80 mV, the blue line the current obtained at -40 mV, the green line the current obtained at -20 mV, and the black line the current obtained at 80 mV. **(B)** I-V relationship obtained from protocol A. Colored squares

correspond to the same-colored depolarizing pulses from protocol A. **(C)** Fast inactivation obtained from protocol A. Squares correspond to τ fast, and triangles to τ slow. **(D)** Macroscopic current traces obtained at -20 mV after a prepulse at different depolarizing potentials of 50 ms with a 5 mV increment. The orange line represents the current obtained after a prepulse of -120 mV, red line after a prepulse of -80 mV, blue line after a prepulse of -40 mV, green line after a prepulse of -20 mV and black line after a prepulse of 5 mV. **(E)** Voltage-dependence of activation graph (g/g_{\max}) obtained from protocol A, and steady-state voltage-dependence of inactivation graph (I/I_{\max}) obtained from protocol B. Colored squares correspond to the same-colored depolarizing pulses from protocol A and B. Discontinuous lines represent how $V_{1/2}$ is obtained. Dark blue area represents the window current.

2.3.3. Inactivated state

The inactivation of the channel starts a few milliseconds after the channel opening as a consequence of a conformational change of the channel upon depolarization. This impairs Na^+ conductance although the voltage sensor is in an active conformation. The inactivation gate closes folding into the channel pore, and the channel goes to an inactivated state.⁵⁵ The membrane must be repolarized to remove the inactivation.^{53,73}

Fast inactivation

With the same protocol applied in Figure 8A, the inactivation time constant can be measured. It is the time that takes to the current to reach 63% of the inactivation upon maximum peak amplitude, at different voltages. By adjusting the current while it is inactivating to a double exponential, two time constants can be obtained: fast tau (τ_f) and slow tau (τ_s) (**Figure 8C**).

Steady-state voltage-dependence of inactivation

The steady-state voltage-dependence of inactivation represents the fraction of channels that remain open after a depolarizing voltage pulse, in which the current has reached a steady-state of inactivation. **Figure 8D** depicts the protocol used to measure I_{Na} at -20 mV, after a series of depolarizing steps. This allows to obtain the fraction of viable channels that can be activated by a -20 mV pulse (I/I_{\max} , **Figure 8E**). Following a -120 mV prepulse (orange), the channels are closed but are available to be opened, and thus peak I_{Na} is maximum when a -20 mV pulse is applied. After a -80 mV prepulse (red) is applied,

a small fraction of channels has already inactivated, and the peak I_{Na} is smaller at the -20 mV pulse. With a more depolarizing prepulse (-40 mV blue, -20 mV green, and 5 mV black), peak I_{Na} after the -20 mV pulse is very small or zero, as most or all the channels have already inactivated.

The steady-state inactivation data can also be fit to a Boltzmann equation of the form:

$$I = \frac{I_{\max}}{1 + \exp \frac{V - V_{1/2}}{k}}$$

where I is peak current amplitude and I_{\max} is maximum current amplitude, $V_{1/2}$ is the voltage at which half of the inactivation occurs, and k is the slope factor that determines how steeply the inactivation curve changes with voltage.

Window current

The window current (**Figure 8E**, painted in dark blue) is determined by the crossover of the voltage-dependence of activation and steady-state inactivation curves, which govern the opening of the sodium channel. In this area, there is a population of channels that are inactivated, but also a fraction of channels that have not inactivated and are in the closed state. Thus, there is a probability that any non-inactivated channel may open spontaneously at these voltages. The current that these few open channels carry defines the window current.

2.3.4. Closed-Inactivated state

Upon membrane repolarization, the gating charged residues of each S4 return to their resting positions closing the activation gate.⁷³ This causes the current deactivation and channels enter in the closed-inactivated state.

Recovery from inactivation

After the current has deactivated, the channels require a certain time to recover and to do the transition to the closed conformation, and thus be available to open again. This lapse of time is known as recovery from inactivation. It can be measured with a two-pulse protocol (**Figure 9 left**). Between both pulses, a resting potential of -120 mV is applied for different duration times (1-40 ms). **Figure 9** shows that the recovery increases exponentially in a few milliseconds when the interpulse interval is increased. Plotting the

current obtained at -20 mV (P2) normalized by the maximum current obtained at the first pulse (P1), allows to measure the recovery from inactivation time constant (τ) when data is adjusted to a mono- or biexponential function (**Figure 9 right**):

$$f(t) = 1 - e^{-\frac{t}{\tau}}$$

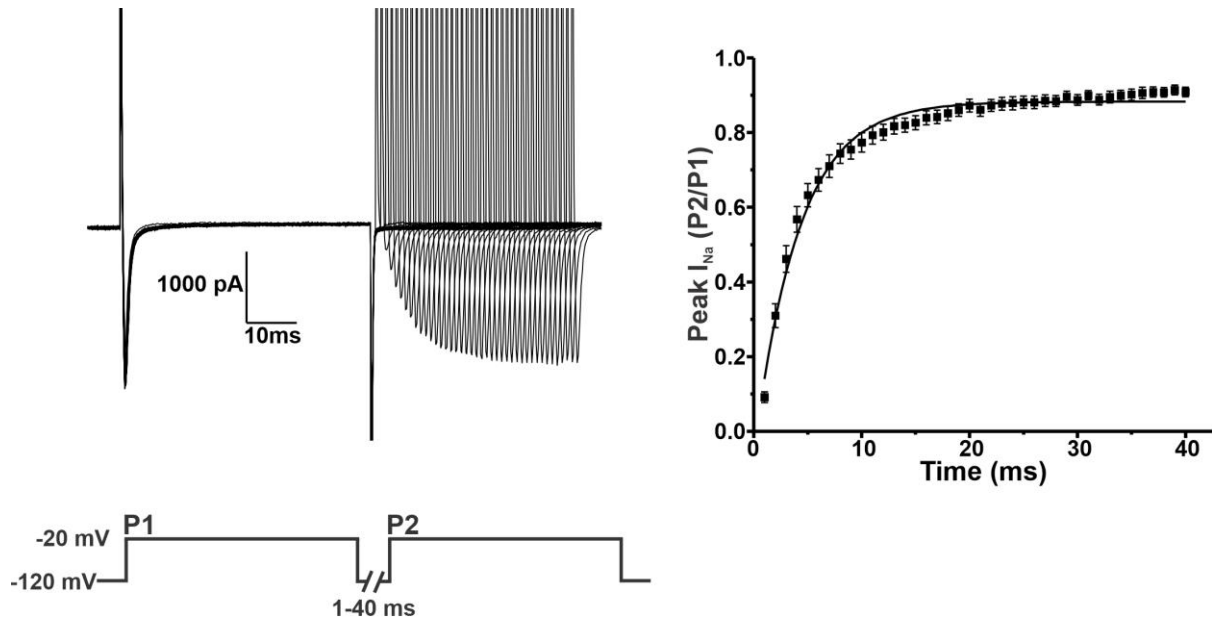

Figure 9. Voltage protocols used to study the recovery from inactivation of voltage-gated sodium channels using the whole-cell patch clamp technique. **Left:** Macroscopic currents obtained after a two-pulse protocol. **Right:** Graph plotting the P2/P1 quotient at each interpulse duration time, adjusted to a monoexponential function.

All the explained properties in this section may be changed by the appearance of a mutation in the VGSC or their regulatory subunits. Thus, this could contribute to an abnormal electrical behavior of the cells.

3. Experimental cellular models for the study of mutations affecting voltage-gated sodium channels

Numerous studies have been performed to understand the mechanisms underlying different channelopathies. Due to methodological and ethical limitations, these studies have been done in animal and cellular models. Murine models are commonly used to study several channelopathies, including cardiac and neuronal arrhythmias.^{74–76} Other models such as porcine and canine, are used to study cardiac channelopathies.^{77–81} Zebrafish and fruit fly animal models have been used in the study of neuronal channelopathies.^{76,82,83}

In addition to the animal models, cellular models are also widely used. These models include heterologous expression systems and tissue-specific cells derived from induced pluripotent stem cells (iPSc). Since the experiments performed in this Thesis involve both cellular models, they will be explained in detail.

3.1. Heterologous expression systems

Vectors carrying mutations identified in voltage-gated sodium channels are usually transfected into heterologous expression systems (**Figure 10**). Cell types used in this approach include human embryonic kidney (HEK) cells, Chinese hamster ovary (CHO) cells and *Xenopus laevis* oocytes.^{76,77,82,84} The current expressed in these cells is studied in patch clamp experiments. Indeed, this strategy has been widely used to study the effect of SNVs in genes associated to arrhythmogenic diseases.^{28,29,93,85–92} This type of studies has provided a detailed analysis of the wild type and mutant channel's biophysical properties, and have contributed to increase our understanding of the molecular mechanisms underlying several channelopathies.

Expression systems

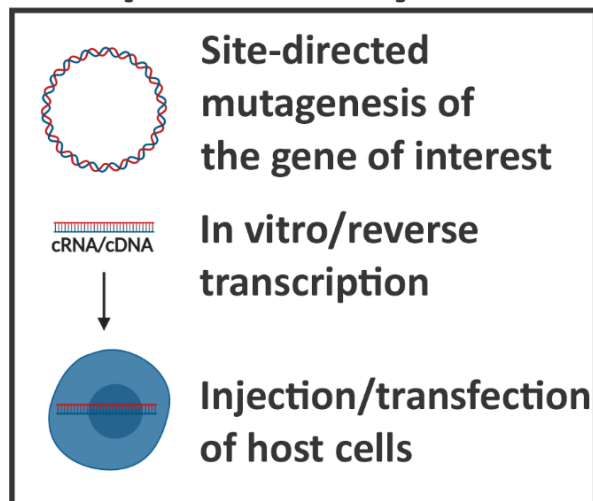

Figure 10. Schematic representation of the heterologous expression system model. Modified from Sendfeld et al.⁷⁷ using BioRender.com.

The principal advantages of using heterologous expression systems are that they are inexpensive, easy to maintain and to manipulate. Nevertheless, this model lacks the specific genetic background of the patient, and thus does not give insight into the incomplete penetrance that some arrhythmogenic diseases display. Furthermore, heterologous expression systems do not display the native environment of the cell types affected by the mutation, such as cardiomyocytes or neurons. To overcome these disadvantages, other model systems had to be applied to the study of mutations affecting voltage-gated sodium channels.

3.2. Tissue-specific cells derived from induced pluripotent stem cells (iPSc)

Since 1958, several approaches of cellular reprogramming have been attempted. The somatic cell nuclear transfer (SCNT) was the first method used, in which the nucleus of a somatic cell is transferred to an enucleated egg.^{94,95} In the following years, the embryonic stem (ES) cells were discovered. These cell lines had a developmental capacity to generate all cell types, known as pluripotency.^{96,97} Some studies also reported that somatic cells such as fibroblasts and T lymphocytes could be epigenetically reprogrammed by cell fusion with ES cells. The resulting reprogrammed cells expressed pluripotency-associated genes including Oct3/4.^{98,99} This suggested the existence of reprogramming factors that could modify the memory of somatic cells.

All these works led Takahashi and Yamanaka to the generation, in 2006, of induced pluripotent stem cells (iPSc) from mouse embryos and adult fibroblasts, using four transcription factors (Oct3/4, Sox2, Klf4 and c-Myc).¹⁰⁰ These iPSc were derived from somatic cells and shared a functional resemblance to ES cells. Soon after, the same group reported the obtention of iPSc from human somatic cells using the same four transcription factors.¹⁰⁹ Posterior studies showed that it was feasible to obtain human iPSc by using different sets of transcription factors.¹¹⁰

iPSc hold the property of pluripotency, and they are capable to differentiate into all somatic cell types. Cells carrying a specific genetic profile can be obtained from patients and be reprogrammed into iPSc. Furthermore, these iPSc can then be differentiated to a specific cell type to mimic characteristic features of a disease. Thus, this approach allows the study of mutant proteins in their native environment.

Therefore, iPSc have become a valuable model to overcome several limitations present in the previously explained model. To date, iPSc suppose a promising approach for drug discovery, disease modelling and regenerative medicine, due to their capacity to differentiate in any type of cell, including neurons and cardiomyocytes (**Figure 11**).

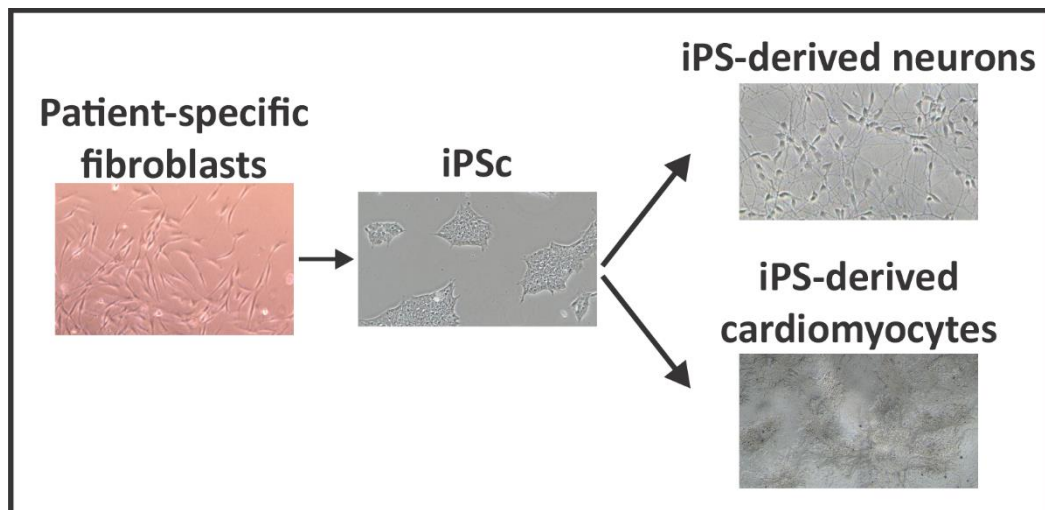

Figure 11. Representation of the iPSc-derived neurons and cardiomyocytes models. The iPSc-derived neurons image is adapted from <https://www.appliedstemcell.com/>.

3.2.1. iPSc-derived neurons

To study the cellular mechanisms of several neurological disorders, patient-specific iPSc-derived neurons have emerged as a valuable cell model. Multiple protocols have been developed to obtain patient-specific iPSc neurons, including spinal cord motor neurons, dopaminergic neurons and neural crest cells among others.^{103–109} These protocols are based in two different approaches. The first one is based in a timed and controlled application of exogenous mitogens and morphogens in culture. The second method used relies in using transcription factors.¹¹⁰

iPSc-derived neurons have been used in the studies of sodium current-related genetic epilepsies, characterized by seizures and abnormal electroencephalograms.^{111,112} The type of epilepsy most extensively studied using iPSc is DS, caused by mutations in the *SCN1A* gene.^{113–115} Other studied epilepsies include febrile seizures caused by mutations in either *SCN1A* or *SCN8A*,^{116,117} or developmental and epilepsy encephalopathies linked to mutations in *SCN1B*.¹¹⁸

3.2.2. iPSc-derived cardiomyocytes (iPS-CM)

In the last years, several protocols for ES cells and iPSc differentiation into cardiomyocytes have been established. One of the first protocols that were developed, was focused in the formation of embryoid bodies. The differentiation in this protocol was achieved by suspending a small number of ES cells within hanging droplets, mirroring the embryonic cell growth conditions. The principal disadvantage of this protocol, was that the cardiomyocyte generation was low (<5%) and with a significant variability.¹¹⁹

Other differentiation protocols focused on using specific growth factors to recapitulate the temporal changes that occur in embryonic cardiogenesis. Although these protocols yielded more than 70% cardiomyocytes, they relied on the use of expensive recombinant proteins and required several steps of cell dissociation and passages.^{120–122}

More recently, differentiation protocols focused on precise temporal modulation of the canonical Wnt pathway. Early activation of this pathway through the molecule CHIR-99021 followed by its inhibition through Wnt-C59 led to a population of cardiomyocytes with >90% purity. The great advantage of these protocols in comparison to previous

ones, was that a monolayer culture was obtained with the use of affordable small molecules.^{123–125}

One of the main advantages in the iPS-CM cell model, is that patient-specific iPS-CMs carry the patient's genetic background. Also, these cells reproduce a cardiomyocyte-like environment. Additionally, this cell model offers the possibility of drug toxicity screening, testing their toxic effects on cardiomyocytes before going into clinical trials.⁷⁷

Patient-specific iPS-CM have been used in the study of channelopathies linked to sodium current mutations. Gain of function mutations in *SCN5A* have been linked to LQT3,¹²⁶ and several studies have elucidated the effect of mutations in this gene using iPS-CM as a cell model.^{127–130} Furthermore, this cell model has allowed to study an *SCN5A* mutation related to an overlap syndrome of both LQT3 and BrS.¹³¹ The majority of studies of *SCN5A* mutations are related to BrS, and will be further discussed in **section 6.2**.

Nevertheless, the main disadvantage is that iPS-CM cultures present cardiac cell type heterogeneity and an immature phenotype compared to adult cardiomyocytes. Indeed, their gene expression profile is more similar to fetal cardiomyocytes.^{77,132} They display spontaneous beating, their membrane potential is more depolarized than adult cardiomyocytes, and they present a poor ultrastructural organization.⁷⁷ Yang *et al.* summarized the differences observed between iPS-CM and adult cardiomyocytes.¹³³

To increase cardiomyocyte purity and exclude or reduce non-cardiomyocytes within the cellular population, a glucose-free lactate-dependent survival metabolic selection has been approached.^{134–136} Several efforts to promote iPS-CM maturation have been made, including prolonged culture duration, electrical stimulation, mechanical stretch, adrenergic and thyroid hormone stimulation, forced overexpression of microRNAs expressed in adult cardiomyocytes, and vascularized 3D engineered cardiac tissues. The review published by Liang *et al.* summarizes all these approaches.¹²⁶

4. Electrical heart activity

The electrical activity of the heart is initiated by an electrical impulse in the sinoatrial node (SAN), located in the right atrium (**Figure 12**). This impulse is generated by the spontaneous excitation of the pacemaker cells, which have intrinsic automatic activity to generate cardiac APs.¹³⁷ The electrical impulse originated in the SAN travels through intercellular gap junctions and depolarizes the adjacent atrial cells, causing the atria excitation and contraction. The wave is propagated through the atrioventricular node (AVN), the His bundle and the Purkinje fibers to the ventricles. The ventricular myocytes are depolarized, resulting in the ventricular excitation and contraction. The whole process leads to the beat of the heart.^{3,138,139}

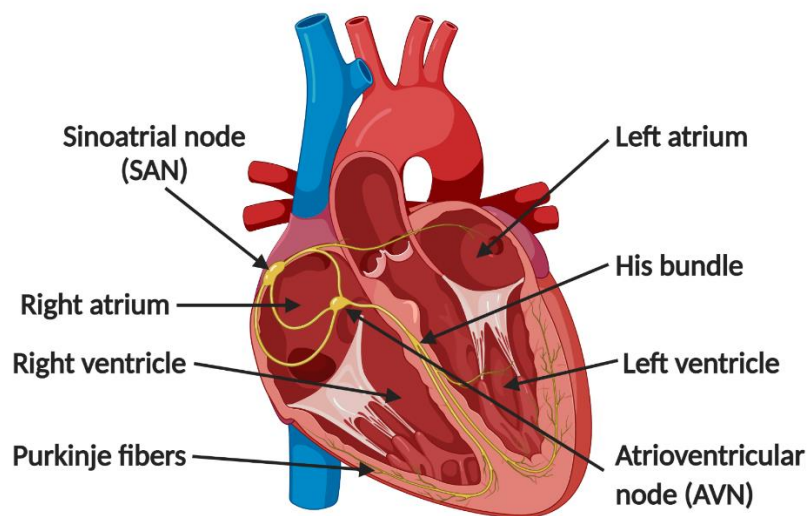

Figure 12. Schematic representation of the human heart. Created with BioRender.com.

4.1. Cardiac action potential (AP)

The cardiac AP is defined as the coordinated changes that take place in the cardiomyocytes membrane potential (V_m). It is triggered by the electrical interaction of the ion channels, transmembranal voltage-gated channels that allow the passive flow of ions following the electrochemical gradient.^{1,139} The ion channels are composed by pore-forming α subunits (**Figure 13**), which are ion-selective mainly for sodium (Na^+), calcium (Ca^{2+}) or potassium (K^+), and regulatory β subunits. In normal physiological conditions, both Na^+ and Ca^{2+} ions flow inside the cell (inward or depolarizing current), and the K^+ ions outside the cell (outward or repolarizing current) through the channels.^{38,139} In excitable cells, such as neurons and cardiomyocytes, the electrical current is due to the electrochemical gradient that exists

across the surface membrane of each cell, and the transmembranal voltage-gated ion channels.¹³⁹

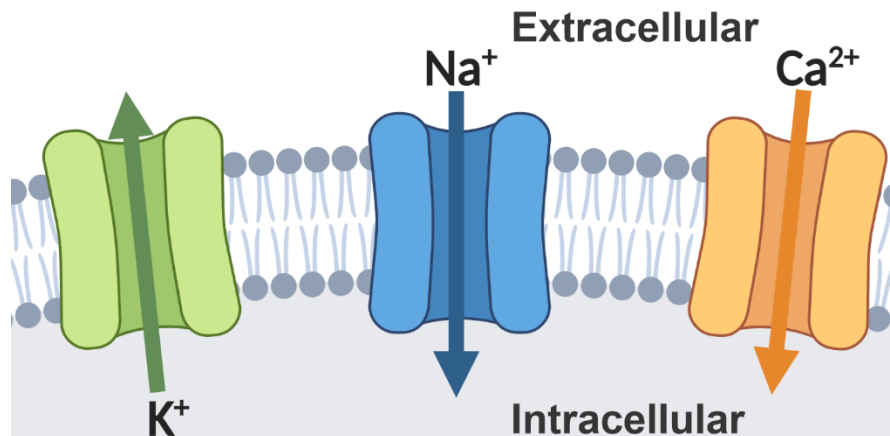

Figure 13. The key ion channels in cardiac cells. The outward current carried by the K^+ channel (colored in green) repolarizes the cell membrane. The inward current carried by Na^+ channels and Ca^{2+} channels (colored in blue and in orange, respectively) depolarizes the cell membrane. Created with BioRender.com.

The ventricular AP is divided in 5 phases, numbered 0-4 (**Figure 14, right**). Here are summarized the main events that drive the AP:^{3,138-140}

- **Phase 0 or Depolarization (Initial upstroke):** In a resting heart, the cardiomyocyte's membrane is permeable to K^+ ions through the inward rectifier K^+ channel (I_{K1} current). The V_m inside the cell is approximately 85 millivolts (mV) more negative with respect to the outside. During cardiac excitation, the membrane becomes permeable to Na^+ ions due to the rapid opening or activation of the voltage-gated Na^+ channels (Na_v). These ions flow into the cardiomyocytes, generating the Na^+ current (I_{Na}), and reverting the V_m to more positive values of approximately +40 mV: this process is called depolarization and starts the AP.
- **Phase 1 or Partial membrane repolarization (Notch):** The inactivation of the Na_v channels a few milliseconds after the start of the AP and the activation of the transient outward K^+ current (I_{to}) in response to the depolarization causes a small repolarization, and the V_m is subtly reverted to more negative potentials.
- **Phase 2 or Plateau:** In this phase there's a gradual activation of different voltage-gated K^+ channels. The K^+ ions exit the cell and produce the outward rectifier current I_K , starting the repolarization of the membrane. In ventricular cardiomyocytes, I_K is

formed by the rapid (I_{Kr}) and slow (I_{Ks}) components. At this point the membrane potential is returning to its basal state, but since there's still an inward current through L-type voltage-gated Ca^{2+} channels (I_{CaL}), the change of V_m is subtle.

- **Phase 3 or Repolarization:** In this phase, the voltage-gated Ca^{2+} channels are inactivated. The complete membrane repolarization starts with the sum of I_{Kr} and I_{Ks} , which is completed by the delayed rectifier and the rectifier currents (I_{Kp} and I_{K1} , respectively).
- **Phase 4 or Resting:** As the final phase, the V_m returns to its baseline of approximately -85 mV. This potential stability is given by the inward rectifier current I_{K1} .

The cardiac AP shape is different among cell types present in every heart region. This is a consequence of the differences in expression and biophysical properties of the ion channels in every region. Figure shows characteristic APs for SAN, atrial and ventricular cells, including which channels underlie each phase of the AP. Of note, in atrial cardiomyocytes the ultra-rapidly rectifier K^+ current (I_{Kur}) is expressed, and thus the repolarization is faster than in ventricular cardiomyocytes. In SAN and AVN cells, the rectifier current I_{K1} is not expressed and this enables a slow depolarization in phase 4 of the AP mediated by the hyperpolarization-activated cyclic nucleotide-gated channels, called funny current (I_f).³ **Figure 14 left and middle** shows the AP of the SAN and atrium.

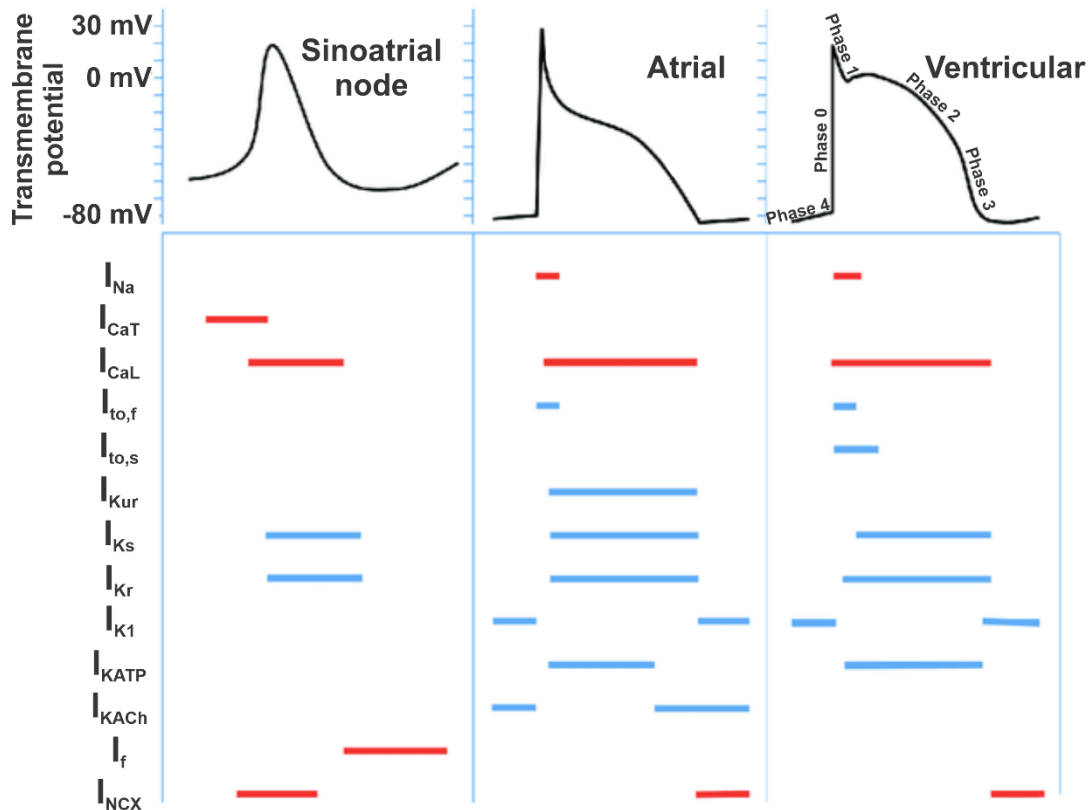

Figure 14. Schematic representation of cardiac APs. Top: SAN (left), atrial (middle) and ventricular (right) AP waveforms. Bottom: Representation of inward (red lines) and outward (blue lines) currents that contribute to the AP formation. Adapted from Lane et al.¹⁴¹

Excitation-contraction (E-C) coupling

The AP triggers the cardiomyocyte contraction. In phase 2 of the AP, Ca^{2+} ions enter the cell through the L-type voltage-gated Ca^{2+} channels, which triggers the activation of the ryanodine receptor located in the sarcoplasmic reticulum (SR). This allows the release of Ca^{2+} ions to the cytosol, which activates the cellular contractile machinery. The whole process is known as the excitation-contraction (E-C) coupling. For cardiac relaxation, the cytosolic Ca^{2+} concentration must decline. This is achieved through the $\text{Na}^+/\text{Ca}^{2+}$ exchanger, which is activated by the increase of the cytosolic Ca^{2+} and allows the entry to the cell of 3 Na^+ ions for every released Ca^{2+} ion generating a net inward current.^{3,139} The SR calcium transport ATPase (SERCA) pump reloads Ca^{2+} from the cytoplasm into the SR. This contributes to muscle relaxation by lowering the cytosolic Ca^{2+} , and refills the SR with Ca^{2+} ions that will be released in the next heartbeat.¹⁴²

4.2. Electrocardiogram (ECG)

The ECG represents the sum of the electrical activity at any given time generated by the cardiomyocytes in the different heart regions (**Figure 15A**). The ECG can be recorded through 10 electrodes placed in the body: 4 limb electrodes and 6 precordial electrodes around the chest. The electrodes are used to make 12 angles or leads, and each lead shows the electrical heart activity from a different location.¹³⁹

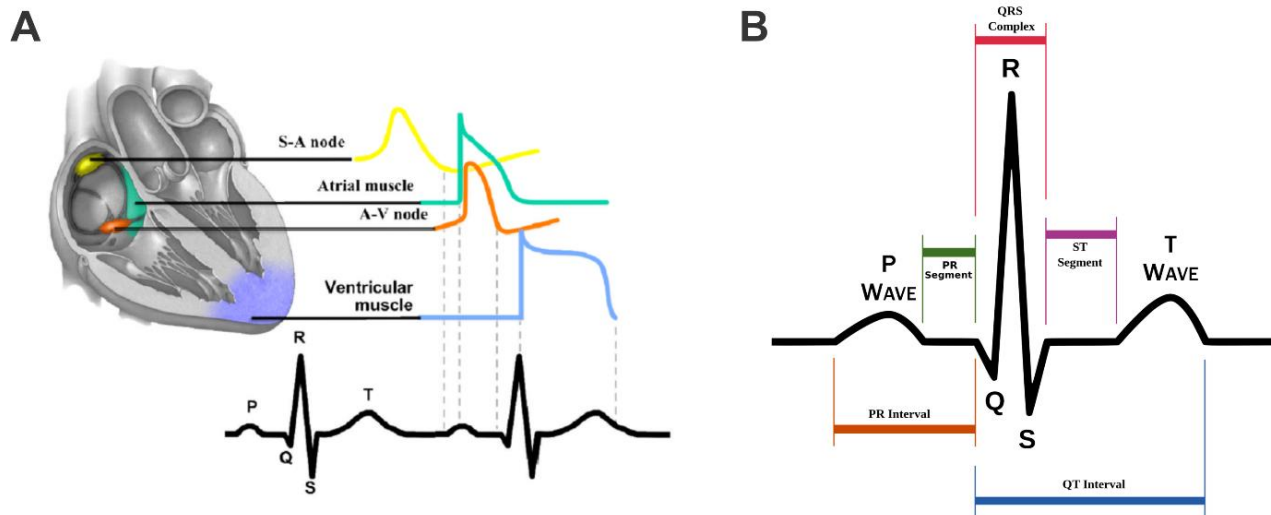

Figure 15. ECG representation. (A) Schematic representation of the cardiac conduction system and the correlation between the action potentials of cardiomyocytes in the areas of the heart (SAN in yellow, atrium in green, AVN in orange and ventricles in blue) and the surface electrocardiogram. Adapted from Giudicessi et al.⁴ (B) Schematic diagram of the intervals, waves, segments and complexes that conform the ECG. Extracted from <https://a-fib.com/>.

The ECG can be described by means of waves and segments (**Figure 15B**). The P wave in the ECG results from the atria depolarization, and is followed by a flat line (PR segment, green) when the electrical impulse is conducted to the ventricles. The QRS complex (red) represents the ventricular depolarization (phase 0 of the previously explained ventricular AP). Since atria repolarization is faster than ventricular repolarization, it is masked in the ECG by the ventricular depolarization. The ventricular repolarization (phase 1, 2 and 3 of the ventricular AP) corresponds to the T wave. Finally, the basal line is the ventricular resting (phase 4) where the resting membrane potential recovery happens.¹³⁹

The duration between the QRS complex and the T wave is used to calculate the ventricular depolarization-repolarization duration, also named as the QT interval (blue). The ST segment

(purple) connects the QRS complex and the T wave and corresponds to the period when the ventricles are depolarized.¹³⁹

The ECG is a useful tool to detect cardiac abnormalities such as blocked arteries, heart damage, heart failure, heart attack and arrhythmias. Alterations in the QT interval have been associated with LQT and short QT (SQT) syndromes, and alterations in the ST segment to BrS.⁴

5. Sudden cardiac death (SCD)

The World Health Organization defines sudden cardiac death (SCD) as a sudden unexpected natural death from a cardiovascular cause, in a patient with or without a previously diagnosed cardiovascular disease, that occurs within one hour of symptoms onset when witnessed. If unwitnessed, it is considered a SCD when the individual was observed to be alive within the previous 24 hours. A sudden cardiac arrest occurs when the heart stops beating, or is not beating sufficiently to maintain perfusion and life, and can lead to SCD.¹⁴³

SCD is a leading cause of mortality, responsible for 50-60% of all deaths worldwide from cardiovascular diseases.¹⁴³⁻¹⁴⁵ Furthermore, it accounts for up to 15-20% of all natural deaths in Western societies¹⁴⁶, being its incidence lower in Asian individuals.¹⁴⁷

SCD results from two factors: an underlying substrate and a transient event. The substrate is a cardiac condition, and the transient event can be any external factor that induces electrical instability in the heart (for example, increasing sympathetic activity).^{6,148-150} In the past decades, substantial progress has been made in SCD prevention and multiple clinical and genetic risk factors that compromise the heart have been identified.¹⁴³

5.1. SCD risk factors

Family history of SCD may represent a risk factor.¹⁵¹ It has been found that the SCD risk is two-fold higher if an individual had one parent who died suddenly, and nine-fold if both parents did. This supports the idea that heritable factors play an important role in determining SCD risk.¹⁴³

Among the clinical risk factors, hypertension, diabetes, smoking and obesity are associated with SCD in both men and women.^{143,147} Other clinical comorbidities can be atrial fibrillation (AF), chronic kidney disease and obstructive sleep apnoea.¹⁴⁴ Depression, anxiety and psychosis are mental illnesses that have been linked to SCD, as well as lifestyle factors such as dietary patterns, emotional stress and air pollution.¹⁴⁷ Gender also plays a fundamental role, being the risk in men three- to four-fold higher compared to women, as well as age.^{143,152}

5.2. SCD cases

The majority of SCD cases occur in adults older than 35 years, and its incidence increases with age.¹⁵³ However, in individuals under 35 years of age, the highest incidence of SCD is in the age group of 0-5 years.¹⁴⁷ SCD in infants younger than 1 year old represent 90% of the cases. The principal cause is the sudden infant death syndrome (SIDS). It is defined as the death of a child younger than 1 year for unknown causes after performing an autopsy and revising the clinical history of both the child and the family.¹⁵⁴ It is considered a multifactorial death. Among these factors are included: child vulnerability (premature or infections), environmental and genetic risk factors and biochemical anomalies. Between 10-20% of the SIDS cases are associated to variants in genes related to channelopathies.^{154,155} In infants older than 1 year and in young teenagers, the main substrates of SCD are cardiomyopathies and channelopathies.^{156,157}

The major cause of SCD in the adult population is coronary heart disease, which represents 75% of the SCD cases.^{149,150} The remaining 25% of the SCD cases in the adults are caused by cardiomyopathies and cardiac channelopathies. Cardiomyopathies are more frequent, and are characterized by anomalies in the heart structure. The principal cardiomyopathies are hypertrophic cardiomyopathy, dilated cardiomyopathy and arrhythmogenic right ventricular cardiomyopathy. Given that these diseases, as well as CHD, are characterized by heart abnormalities, the SCD cause can be explained when an autopsy is performed. These heart abnormalities can be caused by mutations in genes encoding for structural proteins or by clinical factors such as metabolism diseases, pregnancy complications, alcohol and drugs abuse and infections among others.¹⁵⁰ When no alterations in heart structure are identified, a cardiac channelopathy is suspected.

5.3. Cardiac channelopathies

Cardiac channelopathies can be defined as electrical diseases in an apparently healthy heart caused by variants in genes that encode for ion channels or other modulatory proteins, as previously described. The principal cardiac channelopathies are BrS, LQT and SQT syndromes, and catecholaminergic polymorphic ventricular tachycardia (CPVT).

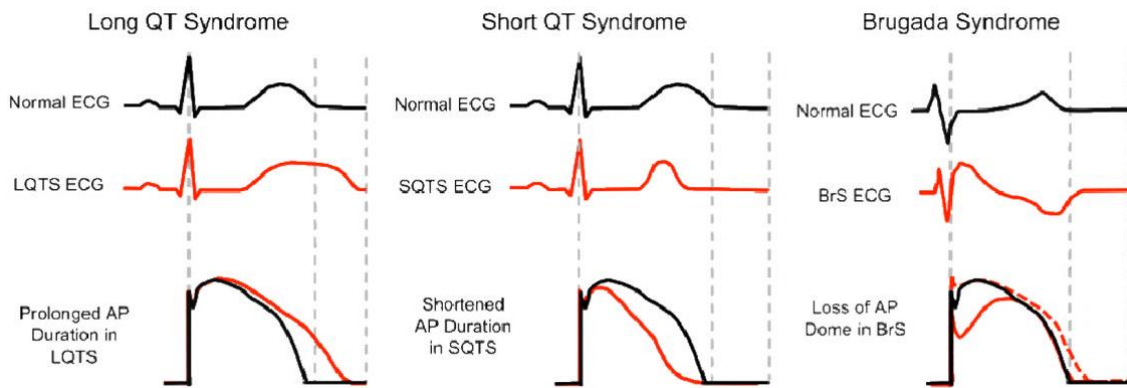

Figure 16. Electrocardiogram in health and disease. The upper trace is the schematic representation of a healthy ECG (black) and of LQT, SQT and BrS Type 1 patients (red). The lower, the schematic representation of healthy (black) and diseased (red) ventricular AP. Adapted from Giudicessi *et al.*⁴

Since the electrical activity of the cells in the different heart regions are perfectly synched, any abnormality in the AP of any of the regions could cause an arrhythmia.¹³⁹ These abnormalities, that can be due to alterations in the expression levels or biophysical properties of the ion channels, can disrupt the ion currents balance, which is essential for a normal AP.^{3,38} These disturbances can lead to a heterogeneity in the AP amplitude and time course and/or coupling between cardiomyocytes of the different heart regions, causing an abnormal cardiac rhythm or arrhythmia that favors SCD (**Figure 16**).^{1,3,38} Thus, ion channels have to be finely orchestrated for a correct heart function.³⁸

As previously mentioned, one of the main causes of channelopathies are mutations in ion channels or their regulatory proteins. However, the sole identification of a mutation does not suffice for the diagnosis of a channelopathy, neither it provides a conclusive prediction of pathogenicity. Information gathered through genetic analyses, as well as the ECG and clinical information of the patient need to be integrated in order to predict the pathogenicity of the mutation. Genetic analyses are particularly useful on giving support to the clinical diagnosis, defining a treatment and identifying mutation carriers at risk of suffering SCD.^{6,158,159} Hundreds of mutations associated to cardiac diseases affecting Na^+ , K^+ and Ca^{2+} ion currents have been identified. These mutations affect either the generation and propagation of the AP or the calcium homeostasis.³⁸

5.3.1. Diseases associated with sodium channel dysfunction

Na⁺ channel dysfunction is linked to several inherited arrhythmia syndromes. These are caused by mutations in *SCN5A*, the gene that encodes for the α subunit of the cardiac sodium channel, or by mutations in the β subunits or other sodium channel modulatory proteins.¹⁶⁰ These mutations can cause either a loss of function, where channel conductance is diminished or abolished, or a gain of function, with an enhanced channel conductance.

An example of these inherited syndromes linked to Na⁺ channel dysfunction is BrS, where I_{Na} is reduced mainly by loss of function mutations in the *SCN5A* gene or its regulatory subunits.^{3,4} This may lead to ventricular fibrillation (VF) and SCD in the young population.³⁸ Since it is the main identified disease I have worked on in this Thesis, BrS will be further explained in **Chapter 6**.

I_{Na} reduction is not only involved with BrS, but also with acquired diseases such as AF. This is the most prevalent arrhythmia in elderly patients, caused by both loss and gain of function mutations in the *SCN5A* gene.¹⁶¹ Other gain of function mutations can cause LQT3.³

5.3.2. Diseases associated with potassium channel dysfunction

Loss of function mutations on six different K⁺ channel-encoding genes are associated to 50-60% of the LQTS cases.^{4,38} Mutations in *KCNQ1*, the gene encoding for the α subunit of the channel responsible for I_{Ks} , can cause LQT1.³ Gain of function mutations in this gene are also involved in SQT2.⁴ Loss of function mutations in *KCNH2/hERG*, the gene encoding for the α subunit of the channel responsible for I_{Kr} , can cause LQT2.^{3,38} Mutations in this gene can also cause SQT1.³ Mutations in *KCNJ2*, encoding for the α subunit of the channel responsible for I_{K1} , may trigger arrhythmias and cause SQT3 and AF.^{3,38}

Mutations in the genes that encode for the K⁺ channels are also involved in other diseases. Gain of function mutations in *KCNE3*, a modulator of the I_{to} current, have been found in patients with BrS and AF.^{3,4} Other patients with AF carried mutations in *KCNA5*, the gene that encodes for the α subunit of $K_v1.5$.³

5.3.3. Diseases associated with calcium channel dysfunction

Loss of function mutations in *CACN1C* and *CACNB2b* (the genes that encode for the α and β subunits of the L-type Ca^{2+} channel, respectively) have been found in BrS and STQ patients.^{3,4,38}

Gain of function mutations in *CACN1C* and *CACNB2b* have been found in LQT patients.⁴ Mutations in intracellular ion channels can also cause arrhythmias. Gain and loss of function mutations in *RyR2*, the gene that encodes for the ryanodine receptor of the SR, are linked to CPVT.^{3,4,38}

6. Brugada Syndrome (BrS)

BrS is a rare inherited cardiac channelopathy characterized by prolonged conduction intervals and an ST segment elevation in the right precordial leads (V₁-V₃) of the ECG. It predisposes to a high risk of SCD, secondary polymorphic ventricular tachycardia and VF, in a structurally normal heart.^{3,162-164}

This disease was first reported in 1992, known as “right bundle branch block, persistent ST segment elevation and sudden death syndrome”. It was observed in 8 individuals resuscitated from SCD who presented a ST segment elevation in the ECG.¹⁶⁵ In 1996, the disease was referenced as BrS for the first time.¹⁶⁶

In 1998 the first mutation linked to this disease was reported.¹⁶⁷ BrS usually displays autosomal dominant inheritance, which was suggested from the first description in 1992.¹⁶⁵ The dominance pattern was later supported by Kobayashi *et al.*, who reported a two-generation family with both SCD and ST segment elevation.¹⁶⁸ It has been reported that 20-50% of the patients suffering this disease have a familiar history of SCD.³⁸

Although its prevalence is low, with 1-5 per 10,000 in Europe and the USA, it has been considered responsible of 4-12% of all SCD cases.^{163,169}

6.1. Phenotype, diagnosis and treatment

The phenotypical presentation of BrS is heterogenous, ranging from patients that suffer SCD to asymptomatic individuals. It is associated with palpitations, syncope, dizziness, malignant ventricular arrhythmias and SCD, which often occur during sleep or at rest.¹⁶⁹⁻¹⁷¹ Only a little percentage of BrS patients have an arrhythmogenic event per year: it has been reported a frequency of 0.5% in patients who, until that event, were asymptomatic; 1.9% in patients that had already experienced a syncope and 7.7% in aborted SCD patients.¹⁷² Aborted SCD is often the first symptom, although a third of the patients are diagnosed after syncope. The majority are asymptomatic at the time of the diagnosis, which in 36% of the cases is done during familial genetic screening.³⁶

BrS is 8-10 times more prevalent in men, which may be explained by differences in ion channel expression and/or hormone levels (e.g., higher I_{to} density and testosterone levels in men).^{160,163} The symptoms typically occur during adulthood (41 ± 15 years), but in some cases are present in children and aged individuals.^{163,173} Indeed, the first cases of BrS in 1992 included three pediatric patients¹⁶⁵, but after that, few pediatric cases have been reported.

Although the majority of BrS patients have a structurally normal heart, some studies have described minor structural alterations in the ventricles.^{174,175}

The diagnosis criteria of BrS apply to children as well as adults, and are based on ECG abnormalities without requiring any further evidence of malignant arrhythmias.¹⁶³ In 2012 a consensus document was published establishing three ECG abnormalities for BrS (**Figure 17**):¹⁷⁶

- **Type 1 (coved type):** Characterized by a ≥ 2 mm ST segment elevation in the right precordial leads (V_1 - V_3) followed by a concave or straight T wave. This can occur spontaneously or can be evoked with an intravenous antiarrhythmic drug test (ajmaline, flecainide, pilsicainide).^{160,163,169} These drugs block the cardiac sodium channel $Nav1.5$, indicating the crucial role of I_{Na} in BrS.¹⁶⁰ The ECG change can also be triggered by fever, as some *SCN5A* mutations alter the gating properties of $Nav1.5$ in a temperature-dependent manner.^{56,177} Physical exercise has also been reported to unmask the ST segment elevation.¹⁶⁰ This type of ECG abnormality is the only pattern that is diagnostic for BrS, although it is spontaneously observed only in 25% of the cases.⁴³
- **Type 2 (saddle-back type):** Characterized by a ≥ 1 mm ST segment elevation followed by a convex T wave. This anomaly is only suggestive for BrS. When a patient displays this ECG morphology, a drug test is performed, and it may change from type 2 to type 1. If this is the case, the patient is diagnosed with BrS.¹⁶³
- **Type 3:** Characterized by an ≤ 1 mm ST segment elevation, with either a coved type or saddle-back morphology. Similar to type 2, this anomaly is only suggestive for BrS and a drug test is performed to try to unmask the type 1 ECG.

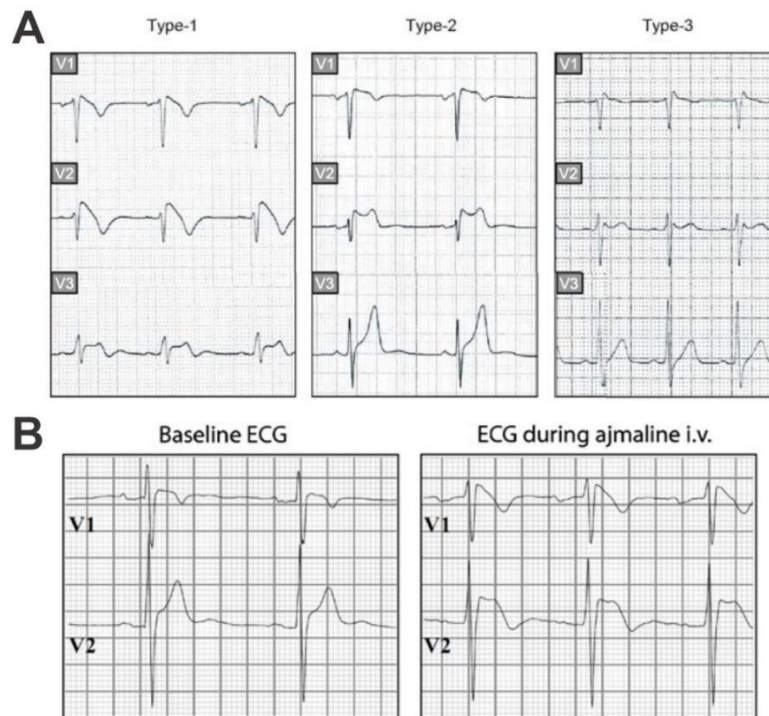

Figure 17. ECG patterns in BrS. (A) Left: Type 1 with ≥ 2 mm ST elevation and concave T wave. **Middle:** Type 2 with ≥ 1 mm ST elevation and convex T wave. **Right:** Type 3 with ≤ 1 mm ST elevation and concave or convex T wave. Adapted from Brugada et al.¹⁷⁸ **(B)** ST segment elevation before and after intravenous (i.v.) administration of ajmaline in an individual with BrS. Adapted from Amin et al.¹⁶⁰

First degree relatives of BrS patients are recommended to undergo a clinical screening. Those patients with a normal ECG should undergo a drug provocative test. They are also recommended to go under a genetic screening, and carriers of a potentially pathogenic mutation should be closely followed.⁴³

The implantation of a defibrillator is the only efficient therapy known in patients with high risk (who had a history of either VF or aborted SCD),⁴³ but it comes with a high cost and complications in 30% of the cases. These complications can be due to dysfunction of the defibrillator, inappropriate therapy or infection.^{36,43,179} Pharmacological therapies that could reduce arrhythmia and prevent SCD by ionic current rebalance are still needed. Since most of BrS patients carry loss of function mutations, it is difficult to compensate for the missing healthy allele.^{43,180} Both isoproterenol and quinidine are the most recommended options to treat BrS.¹⁵⁸ Another approach is the radiofrequency catheter ablation, where there's a disconnection of the right ventricular outflow tract (RVOT), preventing VF.¹⁸¹

6.2. Implicated genes

Approximately 35% of all the BrS cases are caused by missense and nonsense mutations and small nucleotide insertions or deletions.^{160,169} Truncation mutations lead to a more severe phenotype.¹⁸⁰ Of the patients diagnosed with BrS, 20-25% carry a mutation in the gene *SCN5A*.

Up to date, more than 400 identified genetic variants have been identified in this gene.^{77,170,182} When the mutations in *SCN5A* identified in BrS patients are expressed heterologously, most of them lead to loss of function of the cardiac sodium channel, with a reduced peak I_{Na} and/or an alteration in other channel properties.^{77,160} The loss of function may be produced by three different mechanisms:

- **Decreased membrane Nav1.5 protein expression.** This can be caused by either a premature degradation of the protein in the endoplasmic reticulum, or because the protein fails to interact with β subunits or other regulatory proteins that are essential for the protein trafficking to the cell membrane.^{160,183}
- **Non-functional channels** that reach the membrane, but conduct a small amount of Na^+ ions or none at all.^{86,91,92,183}
- **Channels with altered gating properties,** which reach the membrane, but display delayed activation, earlier or faster inactivation, or enhanced slow inactivation. These alterations decrease the probability of the channels to be in the activated stage, thus reducing I_{Na} .^{86,91,92,160,183}

In the *SCN5A* gene there is no hot spot for mutations. Kapplinger *et al.* published in 2010 a compendium of *SCN5A* mutations in patients with BrS which showed that the mutations can be localized throughout the whole protein (**Figure 18**).¹⁸⁴

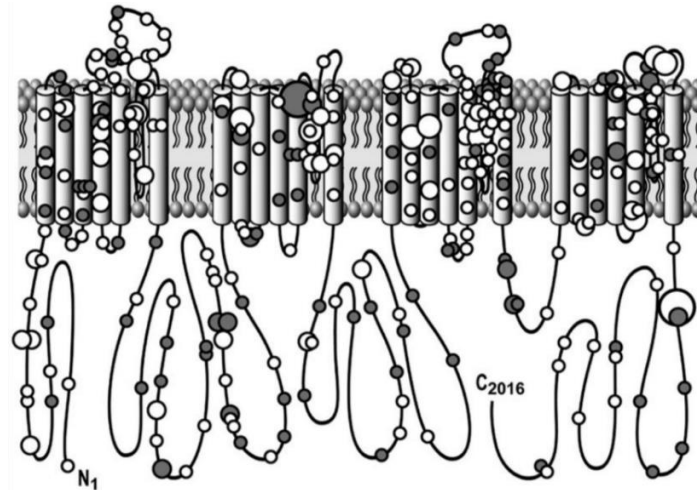

Figure 18. Location of BrS mutations in $Na_v1.5$ channel topology. Missense SNVs are indicated by white circles, other mutation types in gray. The smallest circles indicate a mutation only seen once; medium circles mutations seen in 2-4 patients; large circles mutations observed in 5-9 patients; the largest circle indicates mutations observed in at least 10 patients. Adapted from Kapplinger et al.¹⁸⁴

Besides *SCN5A*, more than 20 genes have been also associated to BrS, although mutations in them are rare and only explain 5-10% of the cases.^{169,182}

- **Other ion channels:** For example, *CACNA1C* and *CACNB2*. Both genes encode for L-type calcium channels and thus mutations in these genes would have an effect in phase 2 and 3 of the AP.^{36,163} A mutation in *KCNE3*, which encodes for MiRP2 (a protein that interacts with $K_v4.3$), have been proven to increase I_{to} thus predisposing to BrS.¹⁸⁵
- **Sodium channel β subunits:** I_{Na} reduction may also be caused by mutations in the genes encoding for the Na_v β subunits.^{160,162} Variants in the gene *SCN1B* encoding for the splice variants $\beta1$ and $\beta1b$, in *SCN2B* encoding for the $\beta2$ and in *SCN3B* encoding for the $\beta3$ subunit, are known to cause BrS. These mutations can impede the proper interaction of the β subunits with $Na_v1.5$ proteins.^{160,162,186-188} Furthermore, *SCN1B* can modulate some *SCN5A* mutations, by aggravating the loss of function of the channel as demonstrated by Wan *et al.*¹⁸⁹
- **$Na_v1.5$ modulators:** mutations in genes such as *GPD1L*, *RANGRF*, *PKP2*, *SLMAP* and *FGF12* can have an effect on I_{Na} .³⁶

Hosseini *et al.* published a study in 2018 where they performed an evidence-based curation of 21 genes reported as single gene causes for BrS, involving 3 curator teams and a clinical expert panel. Only the *SCN5A* gene presented enough evidence to be classified as a definitive diagnostic gene.¹⁹⁰

6.3. Pathophysiological mechanisms of BrS

BrS is usually caused by a loss of function of Na_v channels. The reduction of I_{Na} leads to a decrease of the AP phase 0 depolarization magnitude, slowing atrial and ventricular electrical conduction¹⁶⁰. Two hypotheses have been proposed to try to explain the ST segment elevation, characteristic of BrS (**Figure 19**):

- The **repolarization hypothesis**: It claims that there's an unbalanced repolarization on the right ventricle. According to this hypothesis, APs are shorter in the right ventricle epicardium, where the repolarizing I_{to} is larger, compared to the endocardium.¹⁹¹ In normal conditions, the membrane rapid depolarization activates I_{to} , opposing the depolarization mediated by I_{Na} . Thus, since in the epicardium there's a higher I_{to} density than in the endocardium, the reduction in I_{Na} given by the loss of function of the channel causes an ionic decompensation. This provokes an early repolarization leading to a change in the AP morphology. On the other hand, I_{to} is less relevant in the endocardium so the ionic balance decompensation by I_{Na} reduction is not as prominent, and the AP morphology remains similar. This I_{Na} reduction would further shorten depolarization duration and facilitate reentrant waves between depolarized endocardium and prematurely repolarized epicardium. In summary, the Na_v loss of function leads to an altered AP morphology in the epicardium, which, in turn, causes a transmural voltage gradient between the epicardium and endocardium. This results in the ST segment elevation observed in the ECG (**Figure 19A**).^{160,170,192,193}
- The **depolarization hypothesis**: It states that there's an unbalance in the AP depolarization. I_{Na} reduction would cause a conduction delay in the RVOT, which would lead to a ST segment elevation (**Figure 19B**). This hypothesis is supported by subclinical structural abnormalities in the right ventricles found in some BrS patients.^{160,171}

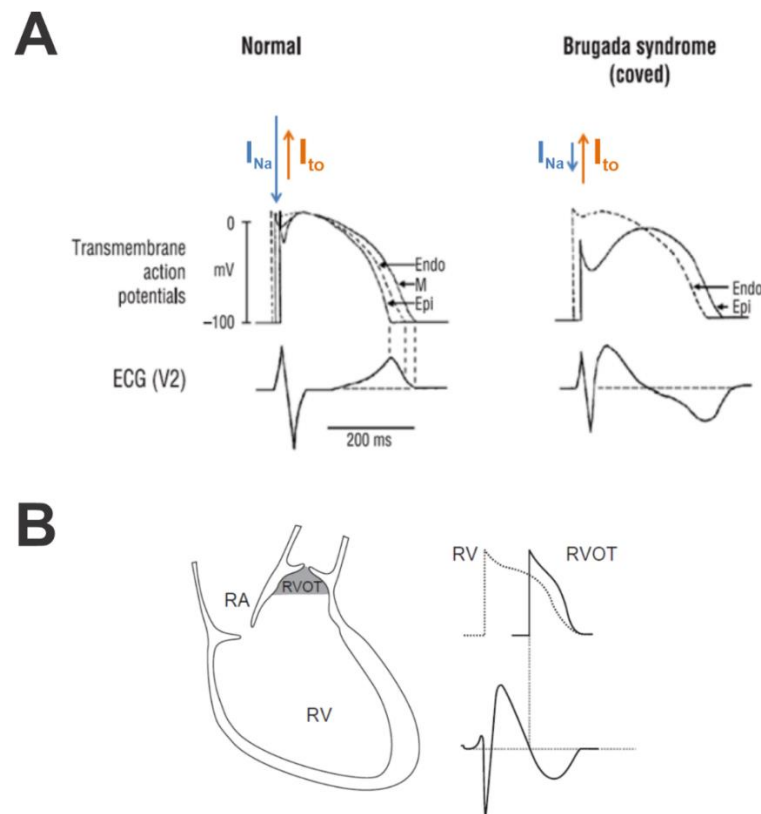

Figure 19. Schematic representation of the ST segment elevation hypotheses. (A) Repolarization hypothesis: I_{Na} dysfunction (blue arrow) shortens the repolarization duration potentially causing BrS. Adapted from Benito *et al.*¹⁹⁴ **(B) Depolarization hypothesis:** I_{Na} reduction causes a conduction delay in the RVOT, resulting in a coved-type ST elevation. Adapted from Meregalli *et al.*¹⁷¹

6.4. Experimental cellular models in Brugada Syndrome

Many models have been used to study BrS. A detailed description regarding the two cellular models used in this Thesis is provided.

6.4.1. Heterologous expression systems in BrS

Our group published in 2019 a compendium of *SCN5A* mutations related to BrS studied in heterologous expressions systems.⁷⁷ Around one-third of the mutations that had been characterized until that publication caused a reduction in I_{Na} density. The observed reduction was proposed to be caused by either a defect in channel trafficking or by alterations in channel's gating properties.

Besides a reduction in I_{Na} , other alterations in the sodium channel properties have been reported for mutations associated with BrS. As an example, the studies of Bezzina *et al.*¹⁹⁵ and Tarradas *et al.*⁹² showed *SCN5A* mutations that produced shifts in the voltage

dependence of activation and steady-state inactivation curves. Other mutations either accelerated or decelerated the speed of inactivation^{196,197}, or prolonged the recovery from inactivation.^{198,199}

Genes other than *SCN5A* associated with BrS have been functionally studied. These studies demonstrated that reduction in I_{Na} can also be caused by mutations in *SCN1B*, *SCN2B*, *SCN3B* and *GPD1-L*.^{162,186,200,201}

6.4.2. iPS-CM in BrS

Loss of function mutations located in the *SCN5A* gene and linked to BrS have been studied using the iPS-CM model. Similar to what has been studied in heterologous expression systems, the loss of function has been proposed to be caused by a channel trafficking defect or gating properties alterations.⁷⁷

The first BrS mutation studied in iPS-CM caused a LQT3/BrS overlap phenotype, as previously stated in section 3.2.2, which caused a decrease in peak and persistent I_{Na} .¹³¹ Our group has reported a SNV in *SCN5A* that lead to I_{Na} reduction, a shift in both the activation and steady-state inactivation curves, and a faster recovery from inactivation.⁹¹ The I_{Na} reduction as well as a shift in the activation curve, caused by an *SCN5A* mutation, has also been observed in other studies.^{85,202,203}

Kosmidis *et al.* reported two *SCN5A* mutations that caused loss of sodium current. Furthermore, they explored the effect of drugs over the mutations, corroborating the use of iPS-CM as a model to study therapeutic tools.²⁰⁴

As over 70% of BrS patients remain without an identified mutation, this cell model allows the study of possible cellular mechanisms and can provide candidate susceptibility genes.^{204,205} The work by Belbachir *et al.* using iPS-CM from BrS patients, allowed the identification of the *RRAD* gene as a potential new susceptibility gene. The SNV located in this gene caused a reduction in I_{Na} and I_{CaL} .²⁰⁶

II. Rationale of the research

Genetic analysis has been very useful for identifying mutations that can potentially cause a disease in a patient, and to detect the mutations in relatives. Furthermore, functional analysis of these mutations has given evidence for their role in several arrhythmogenic diseases.

Nevertheless, severity of the clinical phenotype resulting from a mutation in an ion channel or associated proteins can vary among carriers³⁷. In this situation, the mutation is said to exhibit incomplete penetrance and/or variable expressivity, which are common features of channelopathies. One of the possible explanations of these differences, is that the specific genetic background of each individual, plays a determinant role on the phenotypical expression of a given mutation.

The advent of the next generation sequencing techniques has allowed researchers to obtain information on the genetic background when a candidate mutation is identified. Later on, the possibility of studying patient specific iPSc-derived cardiomyocytes, brought the advantage of studying a given mutation in a patient-specific model.

In this thesis, we used these tools to study two different SNVs linked to arrhythmogenic diseases. First, we characterized the effect of an SNV located in the *SCN1B* gene on both cardiac- and brain-type sodium currents in a heterologous expression system. We discussed our results in view of the whole-exome data obtained from the proband and the detection of specific SNVs in the proband's relatives. Our second study was focused on an SNV located in *SCN5A* that had been related to Brugada Syndrome. We studied the cardiac sodium current properties in iPSc-derived cardiomyocytes of three SNV carriers and a related control from the same family, as well as in heterologous expression systems. In addition, we interpreted these results in the context of data from a genetic panel customized for cardiac arrhythmogenic diseases, performed in the family members to detect other SNVs that could influence the cardiac sodium current properties.

1. SCN1B variant associated with concomitant brain and cardiac disorders

This study was based on the SNV *SCN1B_c.308A>T*, referenced as rs1057519457 in SNP Report (<https://www.ncbi.nlm.nih.gov/snp>). This SNV was identified in a whole exome sequencing study of an 8-year-old male. This child (from now on referenced as proband) carried the SNV in heterozygosis. The whole exome study showed that the proband also carried two *POLR1C* variants in heterozygosis. The protein encoded by the *POLR1C* gene is a subunit of both RNA polymerase I and RNA polymerase III complexes. It is involved in the transcription of DNA into RNA, including ribosomal RNA and transfer RNA which are essential for the normal functioning and survival of the cells. Genetic screening of his progenitors evidenced that he had inherited two of the SNVs (*SCN1B_c.308A>T* and *POLR1C_c.88C>T*) from his father, and one of the SNVs (*POLR1C_c.614delG*) from his mother (**Figure 20**).²⁰⁷

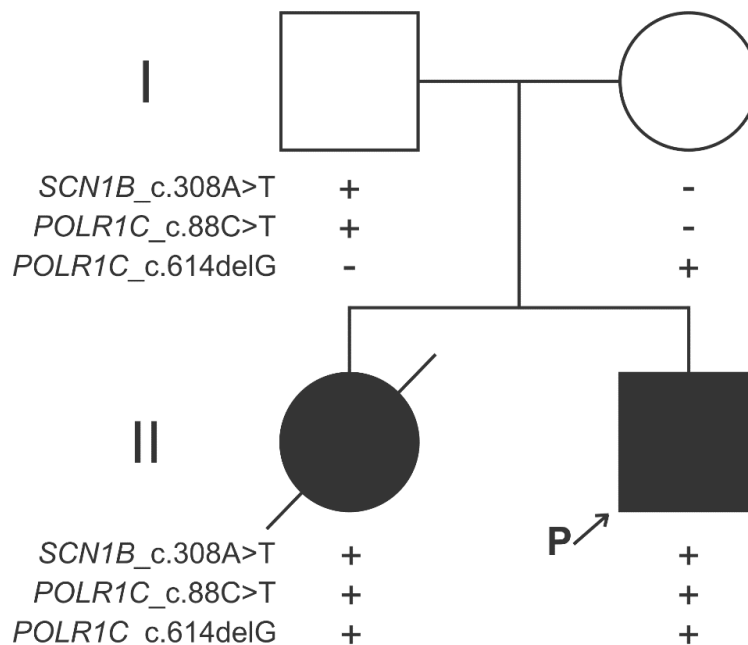

Figure 20. Pedigree of the family carrying the *SCN1B* and *POLR1C* SNVs. Circles represent females, and squares represent males. Clinically affected individuals are shown in black. The + symbol represents SNV carriers, and – symbol the non-carriers of the different SNVs. Arrow indicates the proband. The diagonal line indicates a deceased patient.

The clinical picture of the proband is complex and includes both cardiac and neurological impairment. Both parents are completely asymptomatic, while the proband’s elder sister, who carried the three afore mentioned SNVs, had a fetal diagnosis of bradycardia and subsequent postnatal finding of complete AV block, leading to early neonatal death from multi-organ failure.

The major clinical features of the proband included bradycardia from variable AV conduction disturbance, borderline prolongation of the QTc interval and intraventricular conduction delay, which presented early in the neonatal stage. By the 2nd year of life, he presented global developmental delay and increased tone in the lower extremities. At age 5, neurological examination demonstrated significant cognitive deficits, persistent large-amplitude horizontal nystagmus with primary gaze, normal tone in the upper extremities with mixed spasticity and dystonia in the lower extremities. Brain MRI revealed extensive polymicrogyria involving the bilateral cerebral hemispheres, extensive T2 hyperintense signal throughout the supratentorial white matter with less in the cerebellar white matter and dorsal brainstem, and markedly delayed myelination. At 7 years of age, he also developed recalcitrant atrial tachycardia.

The identified SNV (*SCN1B*_c.308A>T) leads to a substitution of an Aspartic Acid for a Valine at position 103 of the protein ($\beta 1$ _p.D103V and $\beta 1b$ _p.D103V). This changes the hydrophathy of the aminoacid at this position from hydrophilic to hydrophobic, and the polarity from negative to neutral. The SNV is located in exon 3 of the gene. This exon is part of the Ig-like loop of the extracellular domain (ECD) of the protein, which is shared by the two *SCN1B* splice variants: $\beta 1$ and $\beta 1b$ subunits. These subunits have been described to modulate different sodium channels, among which the cardiac-type Nav1.5 and brain-type Nav1.1 channels.

Additionally, the substitution is located in a highly conserved region of the protein which is highly conserved among β subunits in humans and also among $\beta 1$ subunits of different species (**Figure 21**). NCBI dbSNP (<https://www.ncbi.nlm.nih.gov/snp/>) reports a frequency of this SNV of 0%. The PolyPhen-2 (Polymorphism Phenotyping v2, <http://genetics.bwh.harvard.edu/pph2>) tool, which predicts the possible impact of a SNV on the protein structure and function, predicted this SNV to be probably damaging. The SNV was also catalogued as deleterious by the PROVEAN (Protein Variation Effect Analyzer, <http://provean.jcvi.org/index.php>) software, which predicts the impact of a SNV on the biological function of the cells. Additionally, the pathogenicity predictor MutationTaster (<http://www.mutationtaster.org>) classified the SNV as disease causing. Taking all this information into account, this SNV can be considered as possibly pathogenic and could modify the regulatory properties of the $\beta 1$ and/or $\beta 1b$ subunits on the Nav1.5 and/or Nav1.1 channels.

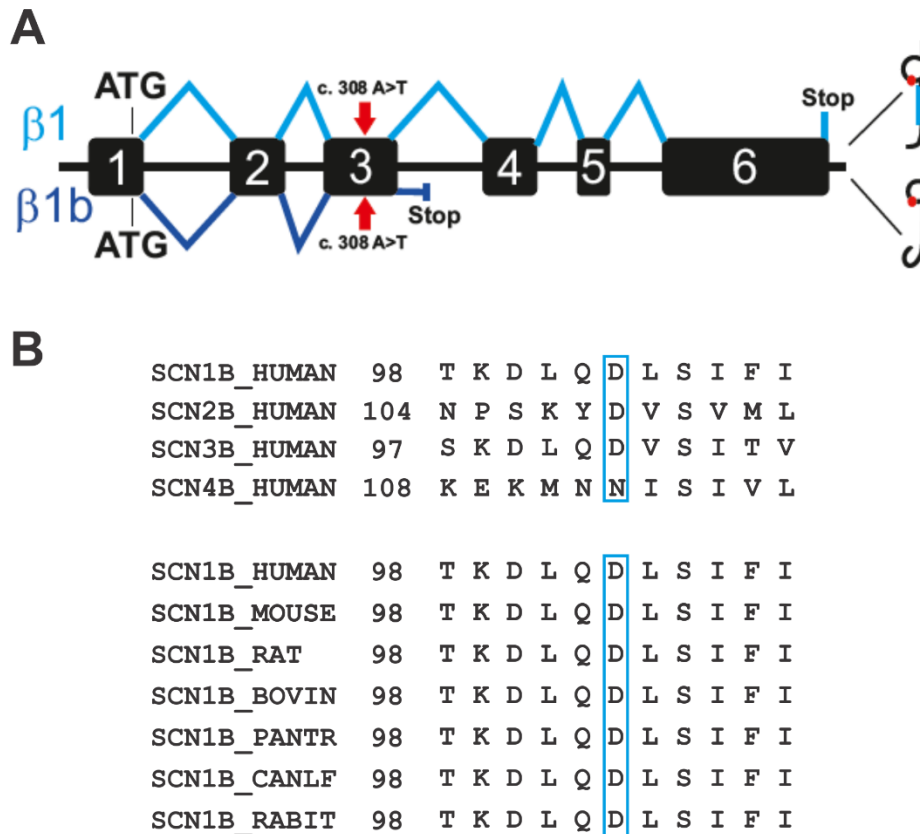

Figure 21. The protein region that includes the SNV SCN1B_c.308A>T is shared by $\beta 1$ and $\beta 1b$ isoforms and is highly conserved. (A) Schematic representation of the genomic (left) and protein (right) structure of $\beta 1$ and $\beta 1b$ isoforms. The black boxes represent the exons of the gene. The blue rectangle indicates the transmembrane domain of $\beta 1$. The red arrows indicate the location of the mutation in the gene, and the red circle the approximate location of the mutation in the protein. The $\beta 1b$ isoform is characterized by a partial retention of intron 3, which renders a protein lacking a transmembrane domain. **(B)** Sequence alignments of the region shared by $\beta 1$ and $\beta 1b$ containing the *SCN1B*_p.D103V mutation were performed using Uniprot. The position of the first amino acid of each sequence is indicated on the left side. The aminoacid affected by the SNV is marked with a blue square. **Top:** Sequence alignment of human voltage-gated sodium channel β -subunit family members. **Bottom:** Sequence alignment of voltage-gated sodium channel $\beta 1$ subunit of different species.

2. SCN5A variant associated with Brugada Syndrome

The second part of this thesis is focused on the SNV *SCN5A*_c.4573G>A. This variant was reported by Kapplinger *et al.*²⁰⁸ and it is included in an international compendium of *SCN5A* SNVs found in patients tested for BrS. The SNV reference in SNP Report is rs199473269. We identified a family with several carriers of this SNV (Figure 22).

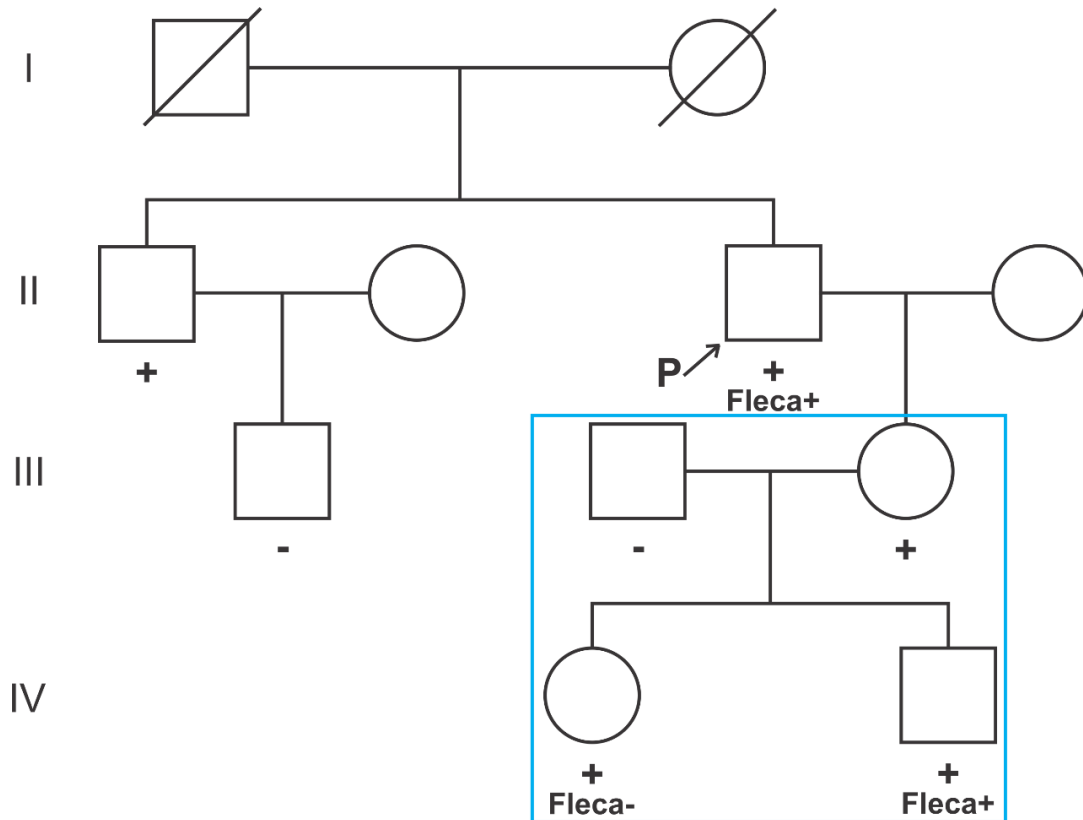

Figure 22. Pedigree of the family carrying the *SCN5A* SNV. Circles represent females, and squares represent males. The + symbol represents SNV carriers, and – symbol the non-carriers. Fleca designates patients which underwent a flecainide test, and the + or – symbols next to it indicate whether the result was positive or negative, respectively. Arrow indicates the proband. Diagonal lines indicate deceased patients. Blue square indicates the individuals that were studied in this Thesis.

The proband had been previously diagnosed with AF. He displayed the typical BrS ECG pattern when he was being treated with flecainide. A genetic analysis of the proband was performed by LABGENETICS in Madrid, and the SNV *SCN5A*_c.4573G>A was identified in heterozygosity. The brother of the proband is also a carrier of the SNV, but it was not inherited by his son.

The daughter of the proband also carries the SNV in heterozygosity. She remains asymptomatic to date. Her husband is not a carrier of the SNV. Their daughter and son, grandsons of the proband, were also genetically tested and both are heterozygous carriers of the SNV. Both

children underwent a Flecainide test, which unmasked the typical BrS type 1 ECG only for the boy. To date, both the girl (18 years old) and the boy (15 years old) remain asymptomatic. However, as stated in the Introduction, BrS symptoms typically develop in the adulthood. Therefore, we cannot discard that these patients will eventually develop symptoms of the disease. In this Thesis, we focused on this latter family unit, which is identified with a blue square in **Figure 22**.

The SNV investigated in this study (*SCN5A_c.4573G>A*) is located in exon 27 of the *SCN5A* gene. It leads to an aminoacidic change from a Valine to a Methionine (*Nav1.5_p.V1525M*), which changes the hydrophathy from hydrophobic to moderate, although the polarity remains neutral. At the protein level, the SNV is localized in a cytoplasmic loop of *Nav1.5*, which connects domains III and IV (**Figure 23A**). This region of the protein contains the inactivation gate of the channel. The Valine in this position is in a region that is highly conserved among different species and among α subunit-encoding genes (**Figure 23B**). This SNV has a frequency in the population of 0.001% according to the Genome Aggregation Database (<https://gnomad.broadinstitute.org>), and of 0.008% according to the NHLBI Exome Sequencing Project (ESP) Exome Variant Server (<https://evs.gs.washington.edu/EVS>). The PolyPhen-2 tool predicted this SNV to be probably damaging, and was catalogued as deleterious by the PROVEAN software. Furthermore, MutationTaster classified the SNV as disease causing. Taking all this information into account, this SNV can be considered as possibly pathogenic and could modify the properties of the *Nav1.5* channel.

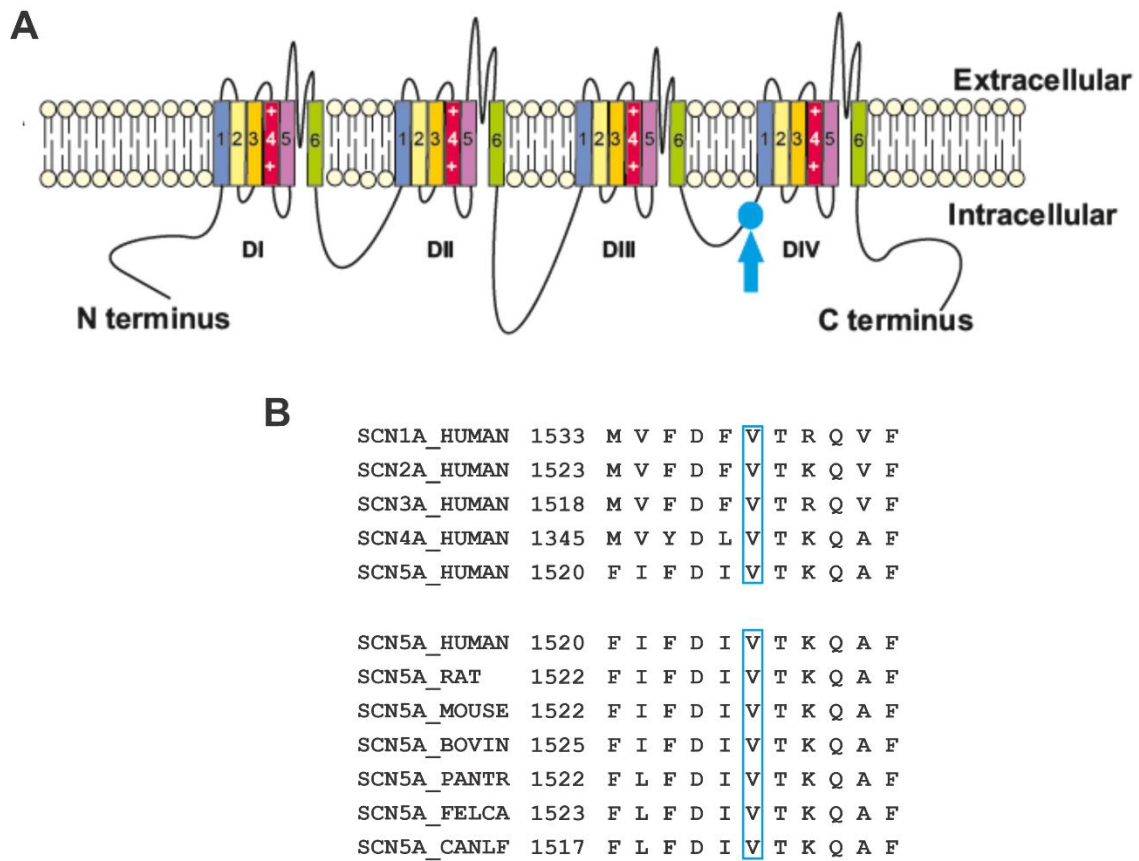

Figure 23. The SNV SCN5A_c.4573G>A is located in a highly conserved region. (A) The approximate location of the SNV in the Nav_v1.5 protein is marked with a blue dot and an arrow. **(B)** Sequence alignments of the region in Nav_v1.5 containing the p.V1525M mutation were performed using Uniprot. The position of the first amino acid of each sequence is indicated on the left side. The aminoacid affected by the SNV is marked with a blue square. **Top:** Sequence alignment of human voltage-gated sodium channel family members. **Bottom:** Sequence alignment of voltage-gated sodium channel Nav_v1.5 of different species.

Thus, current data on channelopathies related to inherited arrhythmogenic diseases together with the evidence presented in this chapter, lead us to propose the hypotheses and specific aims exposed in the following chapter.

III. Hypotheses and Specific Aims

In the previous section, we presented data on two different SNVs associated to inherited arrhythmogenic diseases. Pathogenicity prediction for both mutations suggested that they could explain at least part of the clinical phenotype of the probands. However, the pedigrees of both families, in which clinical and genetic data are shown together, suggested that the SNVs exhibited incomplete penetrance and/or variable expressivity. We propose that this phenotypical difference results from a modulatory effect of the patient-specific genetic background.

Thus, the central hypothesis of this thesis is that **the effect of sodium channel SNVs associated to inherited arrhythmogenic diseases is modulated by the individual's specific genetic background.**

To test this general hypothesis, we proposed separate sub-hypotheses and specific aims related to the SNVs under study as follows:

1. *SCN1B* variant associated with concomitant brain and cardiac disorders

We propose the following specific hypotheses for this study:

- 1.1.** The SNV *SCN1B*_c.308A>T alters the regulatory properties of the $\beta 1$ and $\beta 1b$ subunits over Nav1.5 and Nav1.1 channels.
- 1.2.** The clinical manifestation of the mutant $\beta 1$ and $\beta 1b$ subunits is aggravated by the presence of other patient-specific SNVs.

To assess these hypotheses, we propose the following specific aims:

Specific aim 1. To characterize the effect of the wild type $\beta 1$ and $\beta 1b$ subunits on the electrophysiological properties of the sodium current in HEK-293T cells expressing these β subunits together with either Nav1.5 or Nav1.1.

Specific aim 2. To characterize the effect of the SNV *SCN1B*_c.308A>T in $\beta 1$ and $\beta 1b$ subunits on the electrophysiological properties of the sodium current in HEK-293T cells expressing these mutant β subunits together with either Nav1.5 or Nav1.1.

2. *SCN5A* variant associated with Brugada Syndrome

We propose the following specific hypotheses for this study:

- 2.1. The SNV *SCN5A_c.4573G>A* modifies the sodium current properties of the Nav1.5 channel.
- 2.2. The effect of the SNV on the sodium current properties of the Nav1.5 channel will be different in the three carrier individuals of the same family.
- 2.3. The effect of the SNV on the Nav1.5 current in the iPS-CM derived from the family carriers will be different to the effect observed in HEK-293T cells heterologously expressing the SNV.
- 2.4. The three carrier family members hold other variants that could influence the cellular phenotypical effect of the SNV.

To assess these hypotheses, we propose the following specific aims:

Specific aim 3. To characterize the effect of the SNV *SCN5A_c.4573G>A* on the electrophysiological properties of the sodium current, in HEK-293T cells expressing the wild type or mutant Nav1.5 channel either in homozygosis or heterozygosis.

Specific aim 4. To differentiate patient-specific iPSc to iPS-CM suitable for electrophysiological experiments from the four members of the same family.

Specific aim 5. To characterize the effect of the SNV *SCN5A_c.4573G>A* on the electrophysiological properties of the sodium current, in the patient-specific iPS-CM.

Specific aim 6. To identify differences in the genetic background among the four members of the family, using a sequencing panel that includes genes related to cardiac arrhythmias.

IV. Methods

1. Materials

1.1. Cellular lines

1.1.1. Bacteria

The bacteria used in this thesis to obtain the different expression vectors were XL-10 gold ultracompetent cells (Agilent Technologies, Santa Clara, CA, USA), which were grown in the following media:

Table 1. Media used for bacterial culture

Media	Composition	Company	Additional information
NZY⁺ Broth	0.22 g in 10 ml mQ water	Fisher BioReagents™-Thermo Fisher Scientific (Waltham, MA, USA)	Adjust pH to 7.5 with NaOH. Once autoclaved and cold add 125 µl MgCl ₂ and 200 µl of 20% w/v glucose.
LB-Agar	3.5 g in 100 ml mQ water	NZYTEch (Lisboa, Portugal)	Dispense 20 ml/10cm dish
LB-Broth	2 g in 100 ml mQ water	Sigma-Aldrich-Merck (Darmstadt, Germany)	N/A

1.1.2. HEK-293T

The cellular model to heterologously study the *SCN1B* and *SCN5A* SNVs was human embryonic kidney-293 tsA201 cells (HEK-293T, Health Protection Agency Culture Collections-Salisbury, UK).

The cells were routinely maintained in TC-treated T25 flasks (Corning, New York, NY, USA) at 37°C with 5% CO₂, with Dulbecco's Modified Eagle's Medium (DMEM, **Table 2**).

Table 2. HEK-293T medium composition

Composition	Company
DMEM	Sigma-Aldrich-Merck
10% Fetal bovine serum (FBS)	Gibco-Thermo Fisher Scientific
1% Penicillin - Streptomycin (Pen-Strep)	Gibco-Thermo Fisher Scientific
1% Glutamax	Gibco-Thermo Fisher Scientific

1.1.3. Fibroblasts

Fibroblasts were obtained from skin samples from all the patients and controls used in this Thesis, and maintained with fibroblasts medium (**Table 3**).

Table 3. Fibroblasts medium composition

Composition	Company
DMEM, high glucose plus Glutamax and HEPES	Gibco-Thermo Fisher Scientific
50 µg/ml Gentamicin	Gibco-Thermo Fisher Scientific
1.25 µg/ml Amphotericin B	Gibco-Thermo Fisher Scientific
1% Pen-Strep	Gibco-Thermo Fisher Scientific
10% HyClone FBS	GE Healthcare Life Sciences (Utah, USA)

In the reprogramming protocol to induced pluripotent stem cells (iPSc), 10% DMEM (**Table 4**) and stem cell selection medium (TeSR-E8, STEMCELL Technologies, Vancouver, Canada) were used.

Table 4. 10% DMEM composition

Composition	Company
DMEM, high glucose plus L-glutamine	Gibco-Thermo Fisher Scientific
10% FBS	Gibco-Thermo Fisher Scientific
1% Pen-Strep	Gibco-Thermo Fisher Scientific

1.1.4. Induced pluripotent stem cells

iPSc were routinely maintained in TC-treated 6-well plates (Falcon-Corning) with mTeSR1 medium (STEMCELL Technologies).

1.1.5. Induced pluripotent stem cell-derived cardiomyocytes

The differentiation of iPSc to iPSc-derived cardiomyocytes (iPS-CM) was done in TC-treated 12-well plates (Falcon-Corning) and included 3 different media (**Table 5**, **Table 6**, **Table 7**). The digestion media to replat the cells is described in **Table 8**.

Table 5. Differentiation media composition

Composition	Company
DMEM: Nutrient Mixture F-12	Gibco-Thermo Fisher Scientific
0.064 mg/ml L-ascorbic acid	Sigma-Aldrich-Merck
0.01344 µg/ml sodium selenite	Sigma-Aldrich-Merck
10 µg/ml holo-transferrin	Sigma-Aldrich-Merck
1X chemically defined lipid concentrate	Gibco-Thermo Fisher Scientific
1% Glutamax	Corning
1% Pen-Strep	Corning

Table 6. Starving media composition

Composition	Company
SILAC basal medium	Gibco-Thermo Fisher Scientific
0.0615 mg/ml L-ascorbic acid	Sigma-Aldrich-Merck
0.00844 µg/ml sodium selenite	Sigma-Aldrich-Merck
2.5 µg/ml holo-transferrin	Sigma-Aldrich-Merck
1X chemically defined lipid concentrate	Gibco-Thermo Fisher Scientific
1% Glutamax	Corning
1% Pen-Strep	Corning
147.5 mg/ml L-Arginine	Thermo Fisher Scientific
91.25 mg/ml L-Lysine	Thermo Fisher Scientific

Table 7. Maturation media composition.

Composition	Company
Differentiation media	Described in Table 5
10 µg/ml insulin	Sigma-Aldrich-Merck
1 µM Dexamethasone (Dex)	Tocris Bioscience (Bristol, UK)
0.1 µM 3,3',5-Triiodo-L-thyronine (T3)	Sigma-Aldrich-Merck

Table 8. Digestion media composition

Composition	Company
Differentiation media	Described in Table 5
20% FBS	Gibco-Thermo Fisher Scientific
10 µM Y-27632 2HCl ROCK1 inhibitor (ROCKi)	Deltaclon (Madrid, Spain)
10 µg/ml insulin	Sigma-Aldrich-Merck
1 µM Dex	Tocris-Bio-Techne (Minneapolis, MN, USA)
0.1 µM T3	Sigma-Aldrich-Merck

1.2. Expression vectors

The pcDNA3 vector harboring the cDNA of human *SCN5A* (pcDNA3-SCN5A) was a generous gift from Dr. Matteo Vatta (Baylor College of Medicine, Houston, TX, USA).

The pCMV vector harboring the complementary DNA (cDNA) of human *SCN1A* was a generous gift from Dr. Alfred George Jr. (Vanderbilt, University Division of Genetic Medicine, Nashville, TN, USA).

The cDNA of the human *SCN1B* in a commercially available pCMV6-XL4-SCN1B (OriGene Technologies Inc., Rockland, MD, USA) was subcloned into a bicistronic vector encoding enhanced green fluorescent protein (GFP, pIRES-GFP, Clontech Laboratories Inc., Mountain View, CA, USA). Human *SCN1Bb* cDNA was previously amplified in our group from human heart right ventricle and cloned into pIRES-GFP²⁰⁹.

1.3. Antibodies

The primary antibodies used in this thesis were: rabbit anti-human Nav_v1.1 antibody (Alomone Labs, Jerusalem, Israel) and rabbit anti-human Nav_v1.5 (Alomone Labs).

The secondary antibody used was a horseradish peroxidase-conjugated anti-rabbit (Thermo Fisher Scientific).

1.4. Western Blot and Biotinylation assay buffers

The lysis buffer used to collect the HEK-293T cells is described in **Table 9**.

Table 9. HEK-293T cells lysis buffer composition

Composition	Company
50 mM Tris/HCl pH 6.8	Sigma-Aldrich-Merck
10% Glycerol	Sigma-Aldrich-Merck
2% SDS	Sigma-Aldrich-Merck

The buffers used in the western blot are described in **Table 10**.

Table 10. Western Blot Buffers

Buffer	Composition	Company
5X Loading Buffer	50 mM Tris/HCl, pH 6.8; 10% Glycerol; 2% SDS; 5% β-Mercaptoethanol; 0.004% Bromophenol blue	Sigma-Aldrich-Merck
10X Electrolyte Buffer	25 mM Tris base; 192 mM Glycine; 0.1% SDS	Sigma-Aldrich-Merck
10X Transfer Buffer	25 mM Tris base; 192 mM Glycine	Sigma-Aldrich-Merck

The following reagents were used in the biotinylation assay:

Table 11. Reagents used in the Biotinylation assay

Reagent	Composition	Company
DPBS ⁺	2.68 mM KCl; 1.47 mM KH ₂ PO ₄ ; 0.49 mM Na ₂ HPO ₄ ·7H ₂ O; 137 mM NaCl; 0.49 mM MgCl ₂ ·6H ₂ O; 0.9 mM CaCl ₂	Sigma-Aldrich-Merck
LB1	50 mM Tris/HCl, pH 7.4; 150 mM NaCl; 1 mM EDTA	Sigma-Aldrich-Merck
LB2	LB1; 1% Triton X-100	Sigma-Aldrich-Merck
LB3	LB2; 1 tablet of Protease Inhibitor Cocktail (for 10 ml)	Roche-Merck
SWS	350 mM NaCl; 5 mM EDTA; 0.1% Triton X-100	Sigma-Aldrich-Merck

1.5. Patch Clamp solutions

For the HEK-293T cells the bath solution used was a normal saline solution (140 NK, **Table 12**), while a low Na⁺ solution (**Table 12**) was used for the iPS-CM. For both cells, we used a pipette solution with the composition listed in **Table 13** (130 CsCl).

Table 12. Bath solutions used in the electrophysiological studies. All components are from Sigma-Aldrich-Merck.

Solution	Composition	Company
140 NK	140 mM NaCl; 3 mM KCl; 10 mM HEPES; 1.8 mM CaCl ₂ ; 1.2 mM MgCl ₂	Sigma-Aldrich-Merck
Low Na ⁺	40 mM NaCl; 3 mM KCl; 100 mM NMDG; 10 mM HEPES; 1.8 mM CaCl ₂ ; 1.2 mM MgCl ₂	Sigma-Aldrich-Merck

Table 13. Pipette solution used in the electrophysiological studies.

Solution	Composition	Company
130 CsCl	130 mM CsCl; 1 mM EGTA; 10 mM HEPES; 10 mM NaCl; 2 mM ATP-Mg ²⁺	All from Sigma-Aldrich-Merck, except CsCl from EMSURE - Merck

Both bath solutions were adjusted to pH 7.4 with NaOH using a SympHony pH meter (VWR - West Chester, PA, USA), pipette solution was adjusted to pH 7.2 with CsOH. Osmolality of bath and pipette solutions was adjusted with glucose (Sigma-Aldrich-Merck) to 325 and 308 mOsm respectively, using a VAPRO 5520 Osmometer (Wescor – ELITech Group).

1.6. Other material references

All other reagents, expendables and equipment are numerically referenced in the methods text according to the following list.

1.6.1. Reagents

1. β -Mercaptoethanol: Sigma-Aldrich-Merck
2. 0.05% Trypsin/EDTA: Corning
3. 0.25% Trypsin: Sigma-Aldrich-Merck
4. Amaxa NHDF Nucleofector Kit: Lonza (Basel, Switzerland)
5. Ampicillin: Sigma-Aldrich-Merck
6. Biotin solution: EZ-Link Sulfo-NHS-SS-Biotin (Thermo Fisher Scientific)
7. BSA: Pierce Protein Biology-Thermo Fisher Scientific
8. Clarity: Western ECL Substrate (Bio-Rad Laboratories, Hercules, CA, USA)
9. CHIR99021: Selleckchem (Houston, TX, USA)
10. Chloroform: Sigma-Aldrich-Merck
11. Collagenase B: Roche-Merck
12. DMSO: Sigma-Aldrich-Merck
13. EDTA: Life Technologies-Thermo Fisher Scientific
14. Ethanol: Scharlab,S.L. (Barcelona, Spain)
15. ExoZAP: PureIT ExoZAP PCR CleanUp (AMPLIQON, Odense M, Denmark)
16. FCS: Sigma-Aldrich-Merck
17. Gel-Dye Mix: Agilent Technologies
18. Gelatin: Sigma-Aldrich-Merck
19. Genecellin transfection kit: BioCellChallenge (Toulon, France)
20. Glycine: Sigma-Aldrich-Merck
21. Heparin: Sigma-Aldrich-Merck
22. Hi-Di™ Formamide: Life Technologies-Thermo Fisher Scientific
23. Isopropanol: Scharlab,S.L.
24. IWP2: Tocris-Bio-Techne
25. KAPA SYBR FAST qPCR: Roche – Merck
26. KOSR: Gibco-Life Technologies
27. Lipofectamine 2000: Invitrogen-Thermo Fisher Scientific
28. Matrigel: BD Biosciences (Franklin Lakes, NJ, USA)

29. Methanol: Scharlab,S.L.
30. Molecular weight marker: PageRuler Plus (Thermo Fisher Scientific)
31. NeutrAvidin Ultralink beads: Gibco-Thermo Fisher Scientific
32. Nuclease-free H₂O: Ambion-Life Technologies
33. NucleoSpin® Tissue kit: Macherey-Nagel GmbH & Co KG (Duren, Germany)
34. Opti-MEM: Gibco-Thermo Fisher Scientific
35. PBS: Sigma-Aldrich-Merck
36. Pierce BCA protein assay kit: Thermo Fisher Scientific
37. Poly-L-lysine: Sigma-Aldrich-Merck
38. QIAGEN Plasmid Maxi Kit: QIAGEN (Hilden, Germany)
39. QIAGEN Plasmid Mini Kit: QIAGEN
40. Qiazol: QIAGEN
41. QuantiTect Reverse Transcription kit: QIAGEN
42. QuikChange Site-Directed Mutagenesis kit: Stratagene (La Jolla, CA, USA)
43. RNeasy Mini Kit kit: QIAGEN
44. Skimmed milk powder: Scharlab,S.L.
45. Sodium acetate: Sigma-Aldrich-Merck
46. SureSelect XT Target Enrichment System: Agilent Technologies Inc.
47. TaqMan™ Gene Expression Assay: Applied Biosystems-Thermo Fisher Scientific
48. TE Buffer: QIAGEN
49. TripLE select: Gibco-Thermo Fisher Scientific
50. Tween-20: Sigma-Aldrich-Merck

1.6.2. Consumables

51. 1.5 ml tubes: SARSTEDT AG & Co. KG (Nümbrecht, Germany)
52. 70 µm strainer: Falcon-Corning
53. 100 mm culture dish: Falcon-Corning
54. 15 ml tube: Falcon-Corning
55. 19G needle: Sigma-Aldrich-Merck
56. 21G needle: Sigma-Aldrich-Merck
57. 2 ml tubes: Eppendorf (Hamburg, Germany)
58. 35 mm dishes: Falcon-Corning

59. 50 ml tubes: Falcon-Corning
60. 96-well plate: Axygen-Corning
61. Borosilicate glass capillaries: Sutter Instrument (Novato, CA, USA)
62. Coverslip: Thermo Fisher Scientific
63. Cryovials: SARSTEDT AG & Co. KG
64. Forceps: Heinz Herenz Medizinalbedarf GmbH-VWR
65. Pre-cast SDS acrylamide gels: 4-15% Mini-PROTEAN TGX Stain-Free (Bio-Rad Laboratories)
66. PVDF membrane: GE Healthcare Life Sciences (Chicago, IL, USA)
67. Scraper: Falcon-Corning
68. TC-treated 12-well plates: Falcon-Corning
69. TC-treated 4-well plates: Falcon-Corning
70. TC-treated 6-well plates: Falcon-Corning
71. TC-treated T75 flask: Falcon-Corning
72. RNA chip: Agilent Technologies

1.6.3. Equipments

73. Amaxa Nucleofector 2b: Lonza
74. Axopatch 200B amplifier: Axon Instruments-Molecular Devices (Sunnyvale, CA, USA)
75. Bioanalyzer Agilent 2100: Agilent Technologies
76. Bioruptor®: Diagenode (Belgium)
77. ChemiDoc Imaging System: Bio-Rad Laboratories
78. Cell counter: Invitrogen-Thermo Fisher Scientific
79. Genetic Analyzer 3130XL: Applied Biosystems-Thermo Fisher Scientific
80. Microforge MF-900: Narishige International Limited (London, UK)
81. Microplate reader: Cytation 5 Imaging Reader (BioTek, Winooski, VT, USA)
82. MiSeq platform: Illumina Inc. (California, USA)
83. Mr. Frosty: Freezing container (Nalgene-Sigma-Aldrich-Merck)
84. NANODROP-1000: Thermo Fisher Scientific
85. Narishige PC-10 puller: Narishige International Limited
86. Nikon Eclipse TE300 light microscope: Nikon (Tokyo, Japan)

87. Nikon Eclipse Ti: Nikon
88. pClamp10.2/Digidata 1440A acquisition system: Axon Instruments-Molecular Devices
89. Plate reader: Cytation 5 imaging reader (BioTek, Winooski, VT, USA)
90. Rotating wheel: OVAN (Barcelona, Spain)
91. Sequencer: Genetic Analyzer 3130XL (Applied Biosystems-Thermo Fisher Scientific)
92. Scepter automatic counter: Merck
93. Thermoblock: TS1 ThermoShaker (Biometra, Göttingen, Germany)
94. Veriti™ Thermal Cycler: Applied Biosystems-Thermo Fisher Scientific
95. Vortexer: IKA (Agilent Technologies)

1.6.4. Software

96. Image J: National Institutes of Health
97. Origin 2019: OriginLab Corporation (Northampton, MA, USA)
98. pClamp10.2: Molecular Devices
99. Seqscape v.2.5: Applied Biosystems-Thermo Fisher Scientific
100. Sequencing Analysis v.5.2: Applied Biosystems-Thermo Fisher Scientific

2. Heterologous expression of the SNVs

2.1. Site-directed mutagenesis

pIRES-GFP-SCN1B and pIRES-GFP-SCN1Bb were used as a template to engineer the *SCN1B_c.308A>T* SNV. *SCN5A_c.4573G>A* was introduced in pcDNA3.1-SCN5A. Forward (FW) and reverse (RV) primers (**Table 14**, SNV underlined) to perform the mutagenesis were resuspended and diluted to a final concentration of 100 ng/μl with 50% mQ ultrapure water and 50% TE Buffer (**48**).

Table 14. Primers used to engineer the SNVs

SNV	Primer
<i>SCN1B_c.308A>T</i>	FW: 5' CACCAAAGACCTGCAGG <u>TTCTGTCTATCTTCATCA</u> 3'
	RV: 5' TGATGAAGATAGACAGAA <u>CCTGCAGGTCTTTGGTG</u> 3'
<i>SCN5A_c.4573G>A</i>	FW: 5' CATATTCGACATT <u>ATGACCAAGCAGGCCTTTGACGTCACCATCATG</u> 3'
	RV: 5' CTGCTTGGTCATAATGTGCAATATGAAGCC <u>CTGGTACTTGTTCAGG</u> 3'

The mutagenesis reaction was done using the QuikChange Lightning Site-Directed Mutagenesis Kit (**42**). The mix for the mutagenesis reaction was done in a 1.5 ml tube (**51**) and had the following composition (**Table 15**):

Table 15. Mutagenesis reaction composition

Components	Final concentration
10X Reaction Buffer	1X
50 ng/μl Template vector	50 ng
100 ng/μl Primer FW	125 ng
100 ng/μl Primer RV	125 ng
dNTP mix	N/A
Quiksolution reagent	N/A

After that, 1 μl of QuikChange Lightning Enzyme was added and all components were transferred to 1 well of a 96-well plate (**60**). The mutagenesis reaction was performed using a Veriti™ Thermal Cycler (**93**) with a profile based on an initial template denaturalization, followed with an 18-cycle program of denaturalization, hybridization and elongation, and ended with a final elongation (**Table 16**).

Table 16. Mutagenesis thermal cycler profile

Step	Temperature	Duration	Cycles
Initial denaturalization	95°C	2'	1
Denaturalization	95°C	20''	
Hybridization	60°C	10''	18
Elongation	68°C	9.5'	
Final elongation	68°C	5'	1
Final	4°C	Infinite	1

The mutagenesis was purified with 10 U/ μ l *Dpn I* restriction enzyme (final concentration 20 U), to digest the nonmutated parental template. The plate was incubated at 37°C for 1h.

2.2. Transformation of bacterial culture

XL-10 gold ultracompetent cells were transformed with the purified mutated *SCN1B*, *SCN1Bb* or *SCN5A* vectors. Cells were gently thawed on ice, and 45 μ l of cells were aliquoted in a pre-chilled 1.5 ml tube (51). To increase the transformation efficiency, 2 μ l β -Mercaptoethanol (1) was added to the tubes. The tubes were gently swirled and incubated on ice for 2'. Five microliters of the purified mutagenesis reaction were added and incubated on ice for 30'. The tubes were heat-pulsed at 42°C for 30'' and incubated on ice for 2'. NZY⁺ broth (Table 1) pre-heated at 42°C was added and incubated at 220 rpm 37°C for 1h.

After that, the tubes were centrifuged at 4000 rpm for 3'. Most part of the supernatant was removed, and 50 μ l of the medium with bacteria of each tube were plated in LB-Agar plates (Table 1, 52) with 100 mg/ml Ampicillin (Amp) (5) and incubated at 37°C overnight (O/N).

2.3. Vector purification

A colony from each LB-Agar plate was picked and grown in 4 ml of LB medium (Table 1) containing 100 mg/ml Amp (5), and incubated at 220 rpm 37°C O/N.

To purify the vector DNA introduced in the XL-10 gold ultracompetent cells, the QIAGEN Plasmid Mini Kit was used (39). A glycerol stock composed by 50% glycerol and 50% culture was stored at -80 °C before proceeding. The bacterial cells were harvested by centrifugation at 5400 x g for 10' at 4°C. The pellet was resuspended in Buffer P1 containing RNase A to remove RNA. Buffer P2 was added and mixed by inverting the tube

4-6 times. These two buffers lyse the bacteria under alkaline conditions. Buffer N3 was added and mixed to neutralize the lysate and the tube was centrifuged at 16000 x g for 10' at room temperature (RT). The supernatant was added to a QIAprep spin column which uses a silica membrane, and centrifuged for 1'. The column was washed using Buffer PE to remove salts and centrifuged for 1'. Flow-through was discarded, and the column was centrifuged for 1' at full speed to remove residual wash buffer. The column was placed in a 1.5 ml tube (51), and DNA was eluted by adding Buffer EB (10 mM Tris-Cl, pH 8.5) and centrifuging for 1'.

Eluted DNA was quantified using NANODROP-1000 (84). Concentration measures were performed using an absorbance (A) of 260 nm, a wavelength where nucleic acids absorb. $A_{260\text{nm}}/A_{280\text{nm}}$ was used to assess protein contamination: a pure DNA preparation shows a ratio between 1.8 and 2.0. $A_{260\text{nm}}/A_{230\text{nm}}$ is a secondary measure to assess nucleic acid purity. Values between 2.0 and 2.2 are indicators of DNA purity, while lower values indicate presence of organic solvents. Upon quantification, vector DNA was stored at -20°C.

The eluted DNA was sequenced as described in **section 4.1.2** to verify the presence of the desired SNV and the absence of additional variations.

Upon validation of the presence of the desired SNV, the previously stored bacteria glycerol stock was scratched and grown in 4 ml of LB medium (**Table 1**) containing 100 mg/ml Amp (5) at 220 rpm 37 °C for 5-6h. This starter culture was diluted into a 100 ml of LB medium with 100 mg/ml Amp (5) and grown at 220 rpm 37°C O/N. The QIAGEN Plasmid Maxi Kit (38) was used to purify the vector DNA.

The bacterial cells were harvested by centrifugation at 6000 x g 4°C for 15' and the pellet resuspended with buffer P1. Buffer P2, that helps with cell lysis, was added and mixed by inverting the tube until it results in a homogeneous colored suspension, and incubated at RT for 5'. Pre-chilled buffer P3 was added to the lysate and mixed by inverting the tube. The lysate was poured into the barrel of a cartridge with a cap and incubated at RT for 10'. The cap was removed and the plunger inserted filtering the cell lysate into a 50 ml tube. Buffer ER was added to the filtered lysate and mixed by inverting the tube, incubated on ice for 30'. While the sample was incubated, a QIAGEN-tip was equilibrated by applying buffer QBT and allowing the column to empty by gravity flow. The filtered

lysate was added to the tip and allowed to enter by gravity flow. The tip was washed twice with buffer QC and the DNA was eluted with buffer QN. Eluted DNA was precipitated adding RT isopropanol and centrifuged at 15000 x g 4°C for 30'. DNA pellet was washed with endotoxin-free RT 70% ethanol and centrifuged at 15000 x g for 10'. The pellet was air-dried and buffer TE was added and incubated at 4°C O/N. The volume was transferred to a 1.5 ml tube (51) and quantified using NANODROP-1000 (84) as previously described.

2.4. HEK-293T cell culture

The HEK-293T cells to perform the molecular studies of the SNVs were plated with DMEM medium (Table 2) on 6-well plates (70), while the cells to perform the electrophysiological studies were plated on 35 mm dishes (58) coated with poly-L-lysine (37). They were transiently transfected 24h after plating using Lipofectamine 2000 (27) and Opti-MEM (34) (Table 17). The effect of the $\beta 1b$ subunit on $Na_v1.5$ current was studied using the Genecellin transfection kit (19). The medium of the 6-well plates was changed 24h after transfection, and cells were collected 48h after with lysis buffer (Table 9) for western blot, or for biotinylation assay as indicated in section 4.4. The cells plated on 35 mm dishes were split and plated again on 35 mm dishes, to obtain isolated single cells that allowed the electrophysiology experiments. These experiments were performed approximately 18h after splitting.

Table 17. Transfection conditions studied

Conditions	Amount of vectors used (μ g)
$Na_v1.5^{WT}$ + GFP	1.54 + 0.1
$Na_v1.5^{WT}$ + $\beta 1$ or $\beta 1b^{WT}$	1.54 + 0.46
$Na_v1.5^{WT}$ + $\beta 1$ or $\beta 1b^{D103V}$	1.54 + 0.46
$Na_v1.1^{WT}$ + GFP	1.54 + 0.1
$Na_v1.1^{WT}$ + $\beta 1$ or $\beta 1b^{WT}$	1.54 + 0.46
$Na_v1.1^{WT}$ + $\beta 1$ or $\beta 1b^{D103V}$	1.54 + 0.46
$Na_v1.5^{V1525M/V1525M}$ + GFP	1.54 + 0.1
$Na_v1.5^{WT/V1525M}$ + GFP	0.77 + 0.77 + 0.1

3. Obtaining of patient-specific iPS-CM

3.1. Obtaining of skin biopsies

Our collaborators at Hospital Sant Joan de Déu obtained the skin biopsies. Before performing the biopsy, the skin area of the patients and control was cleaned with ethanol. A scalpel was used to perform an incision that included the dermis, and the blood excess was washed. The biopsies were extracted using forceps and collected in fibroblasts medium (**Table 3**), and were kept on ice until processing.

3.2. Obtaining of fibroblasts

Tissue with a small volume of fibroblasts medium was poured onto the cover of a 100 mm dish (**53**). The sample was dissected into 12-15 pieces with two sterile scalpels. Four tissue pieces were transferred into each of the 3 top wells of a 6-well plate (**70**) using forceps (**64**) and covered with a sterile coverslip (**62**). The coverslips were pressed with the forceps and fibroblasts medium was slowly added. The tissue pieces were cultured at 37°C and 5% CO₂. The first medium change was done 7 days after, and subsequently every 4-5 days. Around day 21, fibroblasts covered the whole surface under the coverslip and were ready for the first passage.

On the first passage, Phosphate-buffered saline (PBS) (**35**) was added to all the wells from the 6-well plate. Coverslips were transferred using forceps from the top wells to the bottom wells, upside-down. PBS was aspirated and TripLE select (**49**) was added and incubated at 37°C for 3'. Fibroblasts medium was added on top and the fibroblasts were detached using a cell scraper (**67**). Medium with fibroblasts and skin pieces was collected in a 15 ml tube (**54**) and centrifuged at 1000 rpm for 4'. The supernatant was aspirated and the cell pellet resuspended in fibroblasts medium, and transferred to a TC-treated T75 flask (**71**). Medium was changed twice a week.

The fibroblasts were ready for freezing when they covered the whole surface of the T75 flask. They were detached as described above and centrifuged at 1000 rpm for 4'. Supernatant was discarded, cell pellet was resuspended with fibroblasts freezing medium composed by fetal calf serum (FCS) (**16**) + 10% Dimethyl sulfoxide (DMSO) (**12**) and distributed into 2 cryovials (**63**). They were stored in a Mr. Frosty (**83**) at -80°C, to be transferred the day after into the LN₂ tank.

3.3. Fibroblasts reprogramming to iPS cells

Fibroblasts were reprogrammed to iPS cells using the Yamanaka factors and the Amaxa NHDF Nucleofector Kit (4). Fibroblasts maintained in a T75 flask were detached as described above. Cells were counted doing a 1:10 dilution and using the Scepter automatic counter (91).

500.000 fibroblasts were aliquoted in a new 15 ml tube (54) and centrifuged at 200 x g for 10'. Cell pellet was resuspended with 100 µl of nucleofection solution (82 µl solution + 18 µl supplement) and transferred to a 1.5 ml tube. A total of 5 µg of the episomal vectors pCXLE-hOCT3/4-shp53-F, pCXLE-hSK and pCXLE-hUL were added to the tube (Table 18, equal amounts of each vector).

Table 18. Vectors used for reprogramming

Vector	Genes encoded	Quantity	Addgene reference
pCXLE-hOCT3/4-shp53-F	Oct4 and shp53	1.7 µg	#27077
pCXLE-hSK	Sox2 and Klf	1.6 µg	#27078
pCXLE-hUL	LMyc and Lin28	1.7 µg	#27080

The mix was gently pipetted up and down and transferred to the cuvette provided by the kit. The cuvette was inserted in an Amaxa Nucleofector 2b (73) and the U023 protocol was selected for maximum nucleofection efficiency. Nucleofected fibroblasts were plated in one well of a 6-well plate (70) coated with 1% gelatin (18) with pre-warmed fibroblasts medium.

Twenty-four hours after nucleofection, medium was replaced with 10% DMEM (Table 4). Media was changed again 3 days later.

Seven days after nucleofection, cells were incubated with 0.05% Trypsin/Ethylenediamine-tetraacetic acid (EDTA) (2) at 37°C for 5'. Medium was poured on top of the cells to detach them, and were collected in a 15 ml tube (54). The tube was centrifuged at 1000rpm for 5' and the cell pellet was resuspended in 10% DMEM. The cells were plated onto a 0.1% gelatin-coated 100 mm culture dish (53). After 24 hours, medium was changed to TeSR-E8. Medium changes were done every two days and cell morphology was assessed using a Nikon Eclipse TE300 light microscope (86).

iPS-like colonies started to appear 20-25 days after nucleofection. Individual colonies were manually picked into separate wells of Matrigel (28) coated TC-treated 4-well plates (69) in TeSR-E8 medium. Colonies were treated as individual clones and expanded to give

rise to independent cell lines. Medium changes were done daily and cells were passaged using 0.5 mM EDTA (13) and a cell scraper (67).

Cells of passages 7-9 were frozen to have a cell stock. Wells were washed with PBS and 0.5 mM EDTA (13) was added and incubated at 37°C for 4'. EDTA was aspirated and cells were collected with TeSR-E8 medium in a 15 ml tube (54) and centrifuged at 200 x g for 5'. Cell pellet was resuspended in freezing medium composed by 90% knock out serum replacement (KOSR) (26) and 10% DMSO (12) and transferred to a cryovial (63). They were kept for 24 hours in a Mr. Frosty (83) at -80°C and stored in a LN₂ tank.

Cell pellets of passages 7 – 11 of each clone were collected for RNA or DNA extraction. Wells were washed with PBS (35), cells were collected into a 15 ml tube (54) by pipetting and centrifuged at 200 x g for 5'. Cell pellets were kept at -80°C until needed.

3.4. Differentiation of iPS cells to iPS-CM

3.4.1. iPS culture

As needed, iPS clones were thawed. mTeSR1 + 10 μM ROCKi medium was prepared in a 15 ml tube (54). A small volume of this medium was aspirated to continue aspirating the cells from the cryovial, and then returned to the tube, which was then centrifuged at 200 x g for 5'. Cell pellet was resuspended with mTeSR1 + ROCKi medium and distributed in the wells of a matrigel-coated 6-well plate (70). Before starting the cardiomyocyte differentiation, a couple of passages were performed to allow cells to adapt from the TeSR-E8 to the mTeSR1 medium.

iPS cells maintained in the 6-well plate were fed every day with mTeSR1, and passaged every 4-7 days. For passaging, cells were washed with PBS (35) and incubated with prewarmed 0.5 mM EDTA (13) at 37°C for 4'. After aspirating EDTA, the plate was gently tapped from all four sides to facilitate cell detachment. mTeSR1 + ROCKi medium was poured on top of the cells and collected in a 50 ml tube (59). Cells were counted using a cell counter (78). 100.000-300.000 cells were plated in mTeSR1 + ROCKi in a matrigel-coated 6-well plate (70) for maintenance.

3.4.2. Cardiomyocyte differentiation

Two clones of each patient and of the control were differentiated into cardiomyocytes. To obtain high yield and pure cardiomyocyte monolayers, a 3-step

protocol was followed, based on three previous publications. First, iPSc were differentiated to cardiomyocytes²¹⁰. In order to enhance the purity of the culture, a starvation protocol was followed, using a medium without glucose¹³⁶. Finally, we aimed to increase the cardiomyocyte maturity by using the differentiation medium with two hormones²¹¹, and replating the cells on day 16 of differentiation.

The first step consisted in: after iPSc cells reached a 90% confluence, they were detached as described above, and 625.000-800.000 cells were plated in each well of a matrigel-coated 12-well plate (68). This was counted as day -3/-2 of the differentiation protocol. mTeSR1 medium was changed every day.

Differentiation began in 2-3 days, when 100% optical confluence was reached, and consisted in changing the differentiation medium (Table 5) with a specific composition every day after exactly 24 hours. This was counted as day 0.

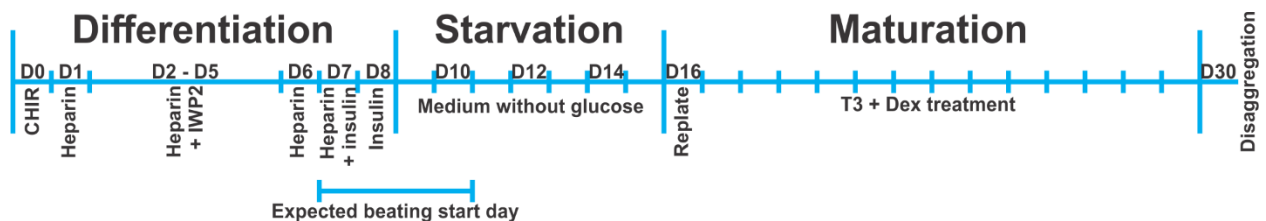

Figure 24. Schematic representation of the optimized differentiation protocol. Protocol based on the studies published by Lin et al, Sharma et al, and Parikh et al, and including our modifications.

Figure 24 summarizes the differentiation protocol followed. On day 0, differentiation started incubating the cells with differentiation medium that contained 4 μ M CHIR99021 (9).

24h later, medium was changed to differentiation medium containing 3 μ g/ml heparin (21). On days 2, 3, 4 and 5, the differentiation medium contained 3 μ g/ml heparin and 3 μ M IWP2 (24).

On day 6, the differentiation medium only contained 3 μ g/ml heparin.

On day 7, differentiation medium contained 3 μ g/ml heparin and 10 μ g/ml insulin.

On day 8, differentiation medium contained 10 μ g/ml insulin. Cells were expected to beat between day 7 and day 10.

On days 10, 12 and 14, the medium SILAC without glucose (Table 6) was used to purify

the cardiomyocyte population, due to the ability of this cell type to metabolize lactate as the primary energy source, while other cell types can't.

On day 16, iPS-CM were replated to a new 12-well plate (**68**). With this, the matrigel from the plate is renewed and a monolayer of beating cells is obtained, which improves their survival. Every well was treated with 400U/mg Collagenase B (**11**) at 37°C for 30'-2h. To allow detachment, cells were slightly shaken every 10'. When the cardiomyocyte monolayer was detached, it was transferred to a 15 ml tube (**54**) and centrifuged at 200 x g for 4'. 0.25% Trypsin (**3**) was added to the cell pellet and the tube was incubated at 37°C for 11'. After that, double volume of previously warmed digestion medium (**Table 8**) was added and cells were gently pipetted up and down. Cells were centrifuged at 200 x g for 4' and cell pellet was resuspended with digestion medium. Cardiomyocytes were strained with a 70 µm strainer (**52**) into a 50 ml tube (**59**), and the strainer was washed with digestion medium. Cells were counted as above and approximately $2.5 \cdot 10^6$ cells were plated on each matrigel-coated well of a 12-well plate.

From day 17 to day 30, medium was changed every day with maturation medium (**Table 7**).

On day 30, cells were plated for functional studies or collected for DNA or RNA extraction.

- For the functional studies, cells were disaggregated using the Collagenase B-based protocol previously described. On the final step, $1 \cdot 10^5$ cells were plated in 0.1% gelatin-coated 35 mm dishes (**58**).
- For DNA extraction, cells were harvested in PBS by centrifugation at 200 x g for 5' and stored at -80°C until used.
- For RNA extraction, cells were pipetted in Qiazol (**40**), collected in 2 ml tubes (**57**) and stored at -80°C until used.

4. Molecular studies

4.1. *SCN5A* sequencing

4.1.1. Genomic DNA extraction

Genomic DNA extraction of iPSc pellets collected and frozen at -80°C was performed following the NucleoSpin® Tissue kit specifications (33). The cell pellets were lysed with buffer T1 that contains SDS. Proteinase K solution was added as well as buffer B3. The sample was vortexed and incubated at 70°C for 15'. 96-100% ethanol (14) was added and the sample was vortexed vigorously. The sample was applied in a NucleoSpin® Tissue column placed in a collection tube, and the DNA was bound to the silica membrane. The column was centrifuged at 11000 x g for 1' and placed into a new collection tube. The silica membrane of the column was washed to eliminate possible contaminations. First, with buffer BW and centrifuging at 11000 x g for 1', then with buffer B5 and centrifuging at 11000 x g for 1'. The membrane was dried by a centrifugation at 11000 xg for 1', and it was placed in a 1.5 ml tube (51). To elute the DNA, buffer BE was added to the column and incubated at RT for 1', and centrifuged at 11000 x g for 1'.

Genomic DNA was quantified using NANODROP-1000 (84). Upon quantification, DNA samples were stored at -20°C.

4.1.2. Amplification, purification and sequencing

Genetic analysis of all exons of the *SCN5A* gene was performed on all iPSc clones. DNA amplification was performed using the polymerase chain reaction (PCR) technique in 96-well plates (60). Every amplification reaction had the composition specified in **Table 19** and a final volume of 12.5 µl adjusted with mQ water. The amplifications were performed using a Veriti™ Thermal Cycler (93) with a profile based on an initial DNA denaturalization, followed with a 40-cycle program (**Table 20**). The correct fragment amplification was verified with a 1.2% agarose electrophoresis gel, run at a voltage of 90 V for 30'.

Table 19. PCR components

Component	Final concentration	Reference
GoTaq G2 Hot Start Colorless Master Mix 2X	1X	Promega (Madison, WI, USA)
10 μ M Primers	0.8 μ M	N/A
10 ng/ μ l DNA	0.8 ng/ μ l	N/A
Nuclease-Free water	N/A	Promega

Table 20. PCR thermal cycler profile

Step	Temperature	Duration	Cycles
Initial denaturalization	95°C	3'	1
Denaturalization	94°C	30"	40
Hybridization	60°C	30"	
Elongation	72°C	45"	
Final elongation	72°C	5'	
Final	4°C	Infinite	1

Amplicons were purified using ExoZAP (15). This reagent contains two enzymes: exonuclease I that degrades single stranded DNA, and shrimp alkaline phosphatase that degrades any remaining dNTP. The reaction was performed in a final volume of 3.5 μ l (1 μ l reagent and 2.5 μ l PCR product). The reaction was performed in a 96-well plate (60) on a Veriti™ Thermal Cycler (93), and the protocol consists of two steps: first the purification reaction at 37°C for 5', and second the enzymes inactivation at 80°C for 5'.

The sequencing reaction was done with the Sanger method using the BigDye Terminator v3.1 kit. The reaction was done in a final volume of 5 μ l in 96-well plates (Table 21), using a Veriti™ Thermal Cycler (93). Sequence reaction profile was based in an initial denaturalization, followed by 25 cycles of denaturalization, hybridization and elongation (Table 22).

Table 21. Sequence reaction components

Component	Final concentration	Company
5X Sequence Buffer	1X	Life Technologies
BigDye® Terminator v3.1 Ready Reaction Mix	1X	Applied Biosystems-Thermo Fisher Scientific
10 mM primer forward or reverse	1mM	N/A
PCR purified product	0.8 ng/ μ l	N/A
H ₂ O	N/A	N/A

Table 22. Sequence reaction profile

Step	Temperature	Duration	Cycles
Initial denaturalization	96°C	1'	1
Denaturalization	96°C	10''	
Hybridization	50°C	5''	25
Elongation	60°C	4'	
Final	4°C	Infinite	1

Once the sequencing reaction was finished, DNA was precipitated using 80 µl per well of an 70% ethanol – sodium acetate solution (45). It was centrifuged at 2000 x g for 45'. The previous solution was eliminated and 150 µl of 70% ethanol (14) was added and centrifuged at 2000 x g for 10'. The precipitated product was resuspended in 10 µl Hi-Di™ Formamide (22) and incubated at 95°C for 10'.

The product was analyzed with capillary electrophoresis using the sequencer (90).

The resulting data was analyzed using Sequencing Analysis v.5.2 (99) and Seqscape v.2.5 (98) software. Data was compared with the reference sequence for *SCN5A* of the NM000335 isoform to determine genetic variations with respect to the human genome.

4.2. Genetic panel associated to arrhythmogenic diseases

This experimental procedure was provided by the Genetic diagnostics section of our group. Briefly, iPSc DNA was fragmented with Bioruptor® (76) and libraries were prepared following the SureSelect XT Target Enrichment System (46) for Illumina Paired-End Sequencing Library protocol. The panel was designed by the group of bioinformaticians in our lab and then validated (SureSelect XT Custom 0.5–2.9 Mb library). All coding regions of described isoforms and intronic positions up to 6 base pairs of the following genes were interrogated:

ABCC9, ACTA2, ACTC1, ACTN2, AKAP9, ANK2, ANKRD1, BAG3, BRAF, CACNA1C, CACNA2D1, CACNA1G, CACNA1H, CACNA1I, CACNB2, CALM1, CALM2, CALM3, CALR3, CASQ2, CAV3, CBL, COL3A1, CRYAB, CSRP3, CTNNA3, GJA1, CTF1, DES, DMD, DMPK, DPP6, DSC2, DSG2, DSP, DTNA, ECE1, EMD, EN1, EYA1, EYA4, FBN1, FBN2, FHL2, FKTN, FLNA, FLNC, GAA, GJA5, GLA, GPD1L, HCN1, HCN2, HCN4, HRAS, JPH2, JUP, KCNA5, KCND3, KCNE1, KCNE2, KCNE3, KCNE4, KCNE5, KCNH2, KCNJ2, KCNJ5, KCNJ8, KCNQ1, KRAS, LAMA4, LAMP2, LDB3, LMNA, MAP2K1, MAP2K2, MYBPC3, MYH11, MYH6, MYH7, MYL2, MYL3, MYLK2, MYOZ2, MYPN, NEBL, NEXN, NF1, NOS1AP, NOTCH1, NPPA, NRAS, NUP155,

PDLIM3, PHOX2A, PHOX2B, PITX2, PKP2, PLN, PRKAG2, PTPN11, RAF1, RANGRF, RBM20, RET, RIT1, RYR2, SCN1B, SCN2B, SCN3B, SCN4B, SCN5A, SCN10A, SDHA, SGCD, SHOC2, SLC22A5, SLC6A4, SLC8A1, SLMAP, SLN, SMAD3, SNTA1, SOS1, SOS2, SPRED1, TAZ, TCAP, TGFB2, TGFB3, TGFB1, TGFB2, TGFB3, TLX3, TMEM43, TMPO, TNNC1, TNNI3, TNNT2, TP63, TPM1, TRDN, TRIM63, TRPM4, TTN, TTR, VCL.

Indexed libraries were sequenced in ten-sample pools per cartridge. Paired-end sequencing process was performed on a MiSeq platform (**82**), with a read length of 2 × 76 bp.

An in-house developed pipeline algorithm was used for the analysis of SNVs and indels. Adaptors and low-quality bases from raw FASTQ files were trimmed and reads were mapped with BWA-MEM (<http://bio-bwa.sourceforge.net/>). Only properly mapped read pairs were selected. The SNV and indel detection was performed with SAMtools v.1.2 (<http://samtools.sourceforge.net/>), together with an ad hoc developed script. The SNVs and indels identified were annotated with dbSNP Build 142 (<http://www.ncbi.nlm.nih.gov/SNP/>), Exome Sequencing Project ESP6500SI-V2 (<http://evs.gs.washington.edu/EVS/>), 1000 Genomes Phase 3 (<http://www.1000genomes.org/>), ExAC v.0.3 (<http://exac.broadinstitute.org/>), Human Gene Mutation Database (<http://www.hgmd.cf.ac.uk/ac/index.php>), ClinVar (<http://www.ncbi.nlm.nih.gov/clinvar/>), ENSEMBL and in-home database IDs.

4.3. *SCN5A* mRNA expression

4.3.1. RNA extraction

Two different protocols of RNA extraction were used depending on the cell line. For the RNA extraction of iPSc pellets collected and frozen at -80°C, the RNeasy Mini Kit kit (**43**) protocol was followed. Buffer RLT with β-Mercaptoethanol was added and pipetted up and down. The lysate was transferred into a Qias shredder spin column placed in a collection tube and centrifuged at 16000 x g for 2'. 70% ethanol (**14**) was added into the sample in the collection tube and pipetted up and down. The sample was transferred into an RNeasy spin column placed in a collection tube and centrifuged at 8000 x g for 15". Flow-through was discarded and DNase solution (70 μl buffer RDD + 10 μl DNase I) was added to the column and incubated at RT for 15'. Buffer RW1 was added to the column and centrifuged at 8000 x g for 15", discarding

the flow-through. Buffer RPE was added twice, centrifuging at 8000 x g for 15" the first time and 2' the second. Column was centrifuged at 16000 x g for 1' and placed in a new 1.5 ml tube (51). The column membrane was incubated with RNase-free water at RT for 1' and centrifuged at 8000 x g for 1'.

A protocol based on Qiazol (40) was used to extract RNA of iPS-CM. Previously collected samples were thawed on ice and cells were fragmented with a syringe and a needle if any clumps remained. First, a 19G needle (55) was used, and then a 21G (56) until no fragments were seen. Upon fragmentation, samples were incubated at RT for 5'. After that, 100% chloroform (10) was added and the sample was vortexed for 45" followed by an incubation at RT for 10'. Samples were centrifuged at 12000 x g 4°C for 15'. The superior transparent phase was transferred to a 1.5 ml tube (51) and 100% isopropanol (23) was added. The tubes were inverted 3-4 times and incubated at RT for 10'. Samples were centrifuged at 12000 x g 4°C for 10'. Cell pellet was washed with 70% ethanol (14) and centrifuged at 12000 x g 4°C for 10'. Ethanol was discarded and the washing step was repeated 4 more times. Samples were incubated on a thermoblock (92) at 55°C until ethanol was evaporated and the pellet looked transparent. Nuclease-free H₂O was added and the pellet was dissolved at 55°C for 10'.

Extracted RNA from both protocols was quantified using the NANODROP-1000 (84). Concentration measures were performed using an A of 260 nm. $A_{260\text{nm}}/A_{280\text{nm}}$ was used to assess protein contamination: a pure RNA preparation shows a ratio of 2.1. $A_{260\text{nm}}/A_{230\text{nm}}$ shows salts and phenol contaminants, the ideal ratio should be greater than 1.5. Upon quantification, RNA samples were stored at -80°C.

RNA quality from iPS-CM samples was assessed using the Bioanalyzer (75). First, a Gel-Dye Mix (17) consisting of RNA gel matrix and RNA dye concentrate was prepared. Then, it was added in the well, marked as a circled G of an RNA chip (Figure 25) (72). RNA marker was loaded in all 12 sample wells and in the well marked with stairs in the figure. RNA ladder was added in the well, marked with stairs, and each sample in each of the 12 sample wells. The chip was vortexed in a vortexer (94) for 1' at 2400 rpm, and loaded in the bioanalyzer.

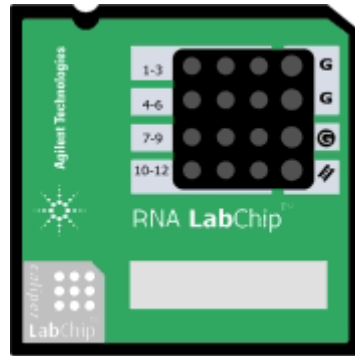

Figure 25. Picture of the Bioanalyzer RNA chip used to assess RNA quality. Adapted from <https://ipmb.sinica.edu.tw/microarray/workshop/workshop-11.pdf>

4.3.2. Retrotranscription

RNA samples were first retrotranscribed to cDNA using the QuantiTect Reverse Transcription kit (41). All samples at a concentration of 500 ng/ μ l were first incubated with gDNA wipeout buffer 7X in a 96-well plate (60) on a Veriti™ Thermal Cycler (93) at 42°C for 2'. Retrotranscription master mix (Table 23) was added to each well and incubated at 42°C for 15' and at 95°C for 3'. Samples were collected in a 1.5 ml tube (51) and used for quantitative PCR (qPCR) or stored at -20°C.

Table 23. Retrotranscription components

Component	Final concentration
Quantriscript Reverse Transcriptase	N/A
Quantriscript RT Buffer 5X	1X
RT Primer Mix	N/A

4.3.3. qPCR

Two different kits were used for the qPCR experiments, which differed in the assay chemistry.

The first kit, KAPA SYBR FAST qPCR (Table 24) (25) contains a dye (SYBR Green) that binds to the double stranded DNA and thus allows the detection of the PCR product. When using this kit, *GAPDH* was used as a housekeeping gene (HKG). All the sequences of the primers used can be found in Annex Table 2.

Table 24. KAPA SYBR FAST qPCR Kit components.

Component	Final concentration
KAPA SYBR FAST qPCR Master Mix (2X) Universal	1X
10 μ M forward primer	200 nM
10 μ M reverse primer	200 nM
Template DNA	25 ng
50X ROX Low	1X
PCR-grade water	N/A

The other assay chemistry used was the TaqMan™ Gene Expression Assay (47), which use a gene-specific fluorogenic probe (Table 25). In these experiments, the HKG used were *PPIA* and *18S*. More information about the probes used can be found in Annex Table 3.

Table 25. TaqMan™ Gene Expression Assay components.

Component	Final concentration
TaqMan® Fast Advanced Master Mix (2X)	1X
TaqMan® Assay (20X)	1X
Template DNA	25 ng
Nuclease-Free Water	N/A

qPCR data analysis was performed with the ThermoFisher Connect tool (<https://www.thermofisher.com/es/es/home/digital-science/thermo-fisher-connect.html>).

4.4. *SCN5A* protein expression

4.4.1. Western blot

HEK-293T cells were collected with the lysis buffer described in Table 9. HEK-293T cells were lysed in a rotating wheel (89) at slow speed for 1h in the cold room. Lysates were centrifuged at 16000 x g 4°C for 15' and supernatant was transferred to a new 1.5 ml tube (51).

Protein concentration was determined with the Pierce BCA protein assay kit (36) using a standard curve with quantities from 0.5 to 7 μ g of bovine serum albumin (BSA) (7) protein in 96-well plates (60).

Diluted samples were added to the plate next to the standard curve wells. BCA reagent was added to each well and the plate was covered with an adhesive plastic and

incubated at 37°C for 30'. The wells' absorbance was read in the microplate reader (**81**) at 562 nm.

Proteins were separated by electrophoresis in pre-cast SDS acrylamide gels (**65**) that include a trihalo compound that reacts with the tryptophan residues in proteins. This allows rapid fluorescence detection of proteins in gels or membranes without staining. Samples were diluted using 5X Loading buffer (**Table 10**) and were heated at 70°C for 10'. Between 20 – 60 µg of protein were loaded in the gel next to molecular weight marker (**30**). Protein separation was done in 1X running buffer (**Table 10**) in two steps. First, a voltage of 100 V was applied for 10' to allow protein concentration. Second, to separate the proteins, a voltage of 160 V was applied until the blue dye front nearly ran out from the gel.

Once the proteins were separated, they were transferred to a PVDF membrane (**66**) in 1X western blot transfer buffer (**Table 10**) with 20% methanol (**29**) at 30 V O/N at 4°C. Gels were read by exposure to UV light in a ChemiDoc Imaging System (**77**) before and after transference, to ensure that most of the proteins were transferred to the membrane.

The membrane was then blocked with 5% skimmed milk powder (**44**) in PBS with 0.1% Tween-20 (PBS-T, **50**) at RT for 1h. It was incubated with either the rabbit anti-human Nav_v1.1 antibody at a 1:100 dilution O/N at 4°C, or the rabbit anti-human Nav_v1.5 at a 1:1000 dilution for 1h at RT.

Membranes were washed twice with PBS-T and once with PBS for 10'. Membranes were further incubated with the secondary horseradish peroxidase-conjugated anti-rabbit antibody at a 1:10000 dilution for 1h at RT. The membranes were washed twice with PBS-T and once with PBS for 10'. Chemiluminescent signal was obtained with Clarity (**8**) and detected using the ChemiDoc Imaging System (**77**). Expression of Nav_v1.1 and Nav_v1.5 was quantified using ImageJ software (**95**). Membrane intensity values for each sample were normalized by the total lane density read in the membrane after protein transfer.²¹² Taylor and Posch demonstrated that this method is a valid approach to normalize western blot data. Furthermore, total lane density normalization rendered better results than the traditional data normalization with

housekeeping proteins. Protein bands linearity was far superior in stain-free total protein measurement than in immunodetection of housekeeping proteins.²¹³

4.4.2. Cell surface protein biotinylation

HEK-293T cells were plated in 6-well plates (**70**). All procedures were done in cold conditions. Cells were washed twice with cold DPBS⁺ (**Table 11**) and incubated with 1 mg/ml of biotin solution (**6**) for 30' with gentle rocking. Cells were washed three times with cold 100 mM glycine (**20**) in DPBS⁺ for 5' with gentle rocking. They were detached from the plate in lysis buffer LB3 (**Table 11**) with the help of scrapers (**67**), and collected in 1.5 ml tubes (**51**). Tubes were placed in a rotating wheel (**89**) at slow speed for 1h to allow cell lysis.

While the cell lysis was performed, the NeutrAvidin Ultralink beads (**31**) were prepared. They were washed twice with DPBS⁺ and twice with LB2 (**Table 11**), and were centrifuged at 3000 x g 4°C for 30". After the last wash, they were resuspended with LB3 (**Table 11**).

Cell lysates were centrifuged at 16000 x g 4°C for 15'. Supernatant was transferred to a new 1.5 ml tube (**51**), keeping 10% of the volume in another tube as the input sample and stored at -80°C. The rest of the sample was referred as the pull-down sample. Pull-down samples were incubated with NeutrAvidin beads O/N in the rotating wheel. Samples were centrifuged at 16000 x g 4°C for 30". Beads were washed by centrifugation at 16000 x g 4°C for 30", once with LB3, twice with LB2, twice with SWS (**Table 11**) and once with LB1 (**Table 11**). Precipitated proteins were resuspended in 5X loading buffer (**Table 10**) and heated at 95°C for 5'. Pull-down samples were kept at -80°C until the western blot was performed as described above.

5. Functional studies

5.1. Sodium current recordings

Sodium currents from HEK-293T cells displaying green fluorescence and from patient-specific iPS-CM were studied at RT using the whole cell patch clamp technique, 48h after transfection or disaggregation respectively. Bath solutions used are described in **Table 12**. Pipettes were pulled from borosilicate glass capillaries (**61**) with a puller (**85**), and further polished using a microforge (**80**) to obtain a resistance that ranged 2-4 M Ω when filled with pipette solution (**Table 13**).

Experiments were conducted with an Axopatch 200B amplifier (**74**) and pClamp10.2/Digidata 1440A acquisition system (**88, 97**), at a sampling rate of 25 kHz.

Data was filtered at 5 kHz. The series resistance compensation of 80-90% was used when necessary, and the leak subtraction was not used.

To permit current stabilization, recordings were performed at least 5 minutes after entering the whole cell configuration. Membrane potentials were not corrected for junction potentials that arose between the bath and the pipette solution.

Sodium currents were studied with voltage-clamp step protocols. To determine the current-voltage (IV) relationship and voltage dependence of activation, cells were held at -120 mV and currents were elicited with depolarizing pulses of 50 ms from -80 to 80 mV in 5 mV increments (**Figure 26, left**). The voltage dependence of inactivation was determined by applying 50-ms prepulses from -140 to 5 mV in 5 mV increments, followed by a -20-mV test pulse (**Figure 26, middle**). Recovery from inactivation was studied with a two-pulse protocol consisting of a first -20 mV pulse of 50 ms from a holding potential of -120 mV, followed by a -120 mV interpulse of varying duration (1-40 ms), and a second -20 mV pulse of 50 ms (**Figure 26, right**).

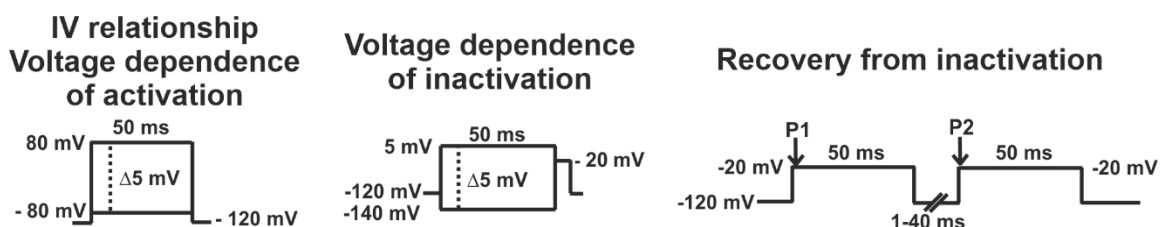

Figure 26. Protocols used for the electrophysiological characterization of the sodium current. Left inset was used to study the IV relationship and the voltage dependence of activation, middle for the voltage dependence of inactivation and right for the recovery from inactivation.

5.2. Data analysis

Data obtained in the sodium current functional studies was analyzed using the Origin 2019 software (96).

Current density was obtained by normalizing the current at each potential by the cell capacitance and plotted against the applied voltage. Voltage dependence of activation data was plotted against the applied voltage and fitted to a Boltzmann equation of the form:

$$g = \frac{g_{max}}{1 + \exp\left(\frac{V_{1/2} - V}{k}\right)}$$

where g is conductance, g_{max} is maximum conductance, $V_{1/2}$ is the voltage at which half of the channels are activated, V is membrane potential and k is the slope factor.

Voltage dependence of inactivation data was plotted against the applied voltage and fitted to a Boltzmann equation of the form:

$$I = \frac{I_{max}}{1 + \exp\left(\frac{V - V_{1/2}}{k}\right)}$$

where I is peak current amplitude, I_{max} is maximum current amplitude, $V_{1/2}$ is the voltage at which half of the channels are inactivated, V is membrane potential and k is the slope factor.

Recovery from inactivation data was fitted to a mono- or bi-exponential function to obtain the time constant. P1/P2 peak current values were plotted against different interpulse intervals.

6. Statistical analyses

Data normality was verified with the Kolmogorov-Smirnov test. Statistical comparisons of the means between two groups were performed using the parametric test t-test, for the analysis of electrophysiological data of **Study 1** and the iPS-CM of **Study 2**, Western blot and cell surface biotinylation assay. The parametric test one-way ANOVA with a post-hoc Tukey test was used for comparisons that included three or more groups. This test was used for the analysis of electrophysiological data of the HEK-293T cells of **Study 2** and the qPCR experiments. Differences were considered statistically significant when p value was lower than 0.05 ($p < 0.05$).

V. Results

Study 1: *SCN1B* variant associated with concomitant brain and cardiac disorders

As mentioned in the **Rationale of the research section**, the SNV *SCN1B_c.308A>T* was found in a patient with concomitant heart and brain disorders. Given the clinical phenotype of the proband, and since the SNV affects the resulting protein in a region that compromises both $\beta 1$ and $\beta 1b$ subunits, one of the main hypotheses in this study is that the SNV *SCN1B_c.308A>T* alters the regulatory properties of both $\beta 1$ and $\beta 1b$ subunits over Nav1.5 and Nav1.1 channels. To test this hypothesis, we investigated the effect of these two mutant subunits on the electrophysiological properties of the sodium current heterologously expressed in HEK-293T cells. HEK-293T cells were transiently transfected with the vector encoding Nav1.5 or Nav1.1 alone, or in combination with either the wild type (WT) or mutated $\beta 1$ and $\beta 1b$ subunits (see **Methods section 2.4**). We recorded sodium currents using the whole cell configuration of the patch clamp technique, 48h after transfection. Isolated cells were bathed in normal sodium solution (for a complete explanation, see **Methods chapter 5**).

1. Nav1.5 current properties are modified by $\beta 1^{WT}$ and $\beta 1b^{WT}$ subunits

Although the effect of both $\beta 1^{WT}$ and $\beta 1b^{WT}$ on Nav1.5 sodium current properties had been previously characterized by several groups, we studied these effects in HEK-293T cells to have a direct control of our experiments with the mutated subunits.

We studied the current-voltage (I-V) relationship of the sodium current. Peak I_{Na} was normalized to cell capacitance and plotted against the applied voltage. Co-expression of Nav1.5 with either $\beta 1^{WT}$ or $\beta 1b^{WT}$ increased peak I_{Na} density (41.2 and 42.8%, respectively) compared to Nav1.5 alone (**Figure 27B** and **Table 26**).

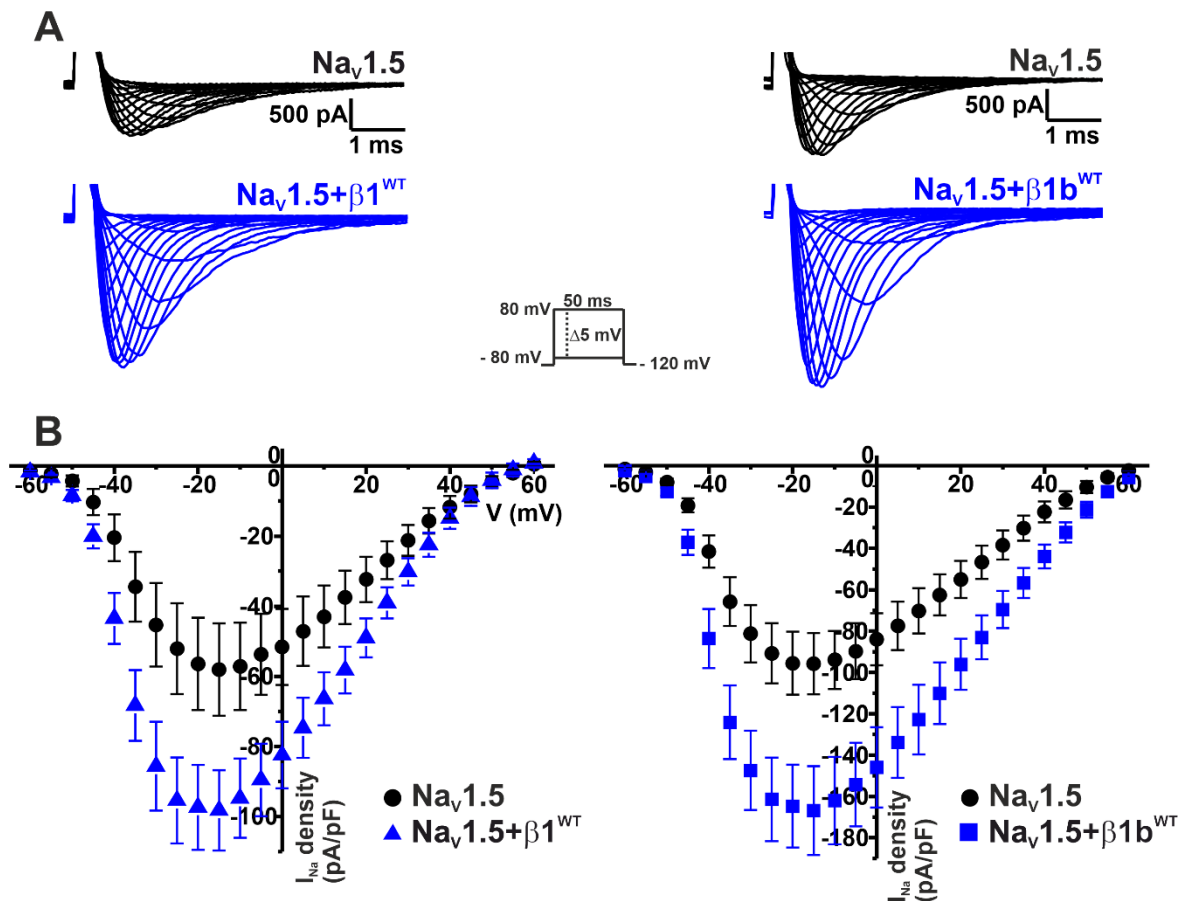

Figure 27. Both $\beta 1^{\text{WT}}$ and $\beta 1b^{\text{WT}}$ increase $\text{Na}_v1.5$ peak I_{Na} . Whole cell currents were elicited by depolarizing potentials as shown in the insets. Black circles depict data for $\text{Na}_v1.5$ alone, blue triangles represent $\text{Na}_v1.5+\beta 1^{\text{WT}}$ and blue squares represent $\text{Na}_v1.5+\beta 1b^{\text{WT}}$. Values are expressed as mean \pm SEM. **(A)** Representative whole cell Na^+ current traces from $\text{Na}_v1.5$ alone (top), $\text{Na}_v1.5+\beta 1^{\text{WT}}$ (bottom left) and $\text{Na}_v1.5+\beta 1b^{\text{WT}}$ (bottom right). **(B)** Mean current-voltage relationship of the $\beta 1^{\text{WT}}$ studies (left) and $\beta 1b^{\text{WT}}$ studies (right). Peak I_{Na} amplitude was normalized by the cell capacitance to obtain Peak I_{Na} density values.

We next studied the voltage-dependence of activation (g/g_{max}) and steady-state inactivation (I/I_{max}). Data obtained was plotted against the applied voltage and fitted to a Boltzmann equation to obtain $V_{1/2}$ and k values (see **Methods section 5.2**). Of note, the $\beta 1^{\text{WT}}$ subunit induced a negative shift of 5 mV in the voltage dependence of activation compared to $\text{Na}_v1.5$ alone (**Figure 28A left panel** and **Table 26**). No changes were observed in voltage dependence of activation upon expression of $\text{Na}_v1.5+\beta 1b^{\text{WT}}$ (**Figure 28A right panel** and **Table 26**). Voltage dependence of inactivation was not altered by either $\beta 1^{\text{WT}}$ or $\beta 1b^{\text{WT}}$ subunits (**Figure 28A** and **Table 26**).

We also measured the recovery from inactivation. **Figure 28B** shows P2/P1 peak current values plotted against different interpulse intervals. Tau (τ) was obtained by fitting the data to a monoexponential function. Both $\text{Na}_v1.5+\beta1^{\text{WT}}$ and $\text{Na}_v1.5+\beta1b^{\text{WT}}$ currents displayed faster recovery from inactivation compared to $\text{Na}_v1.5$ alone (**Figure 28B** and **Table 26**).

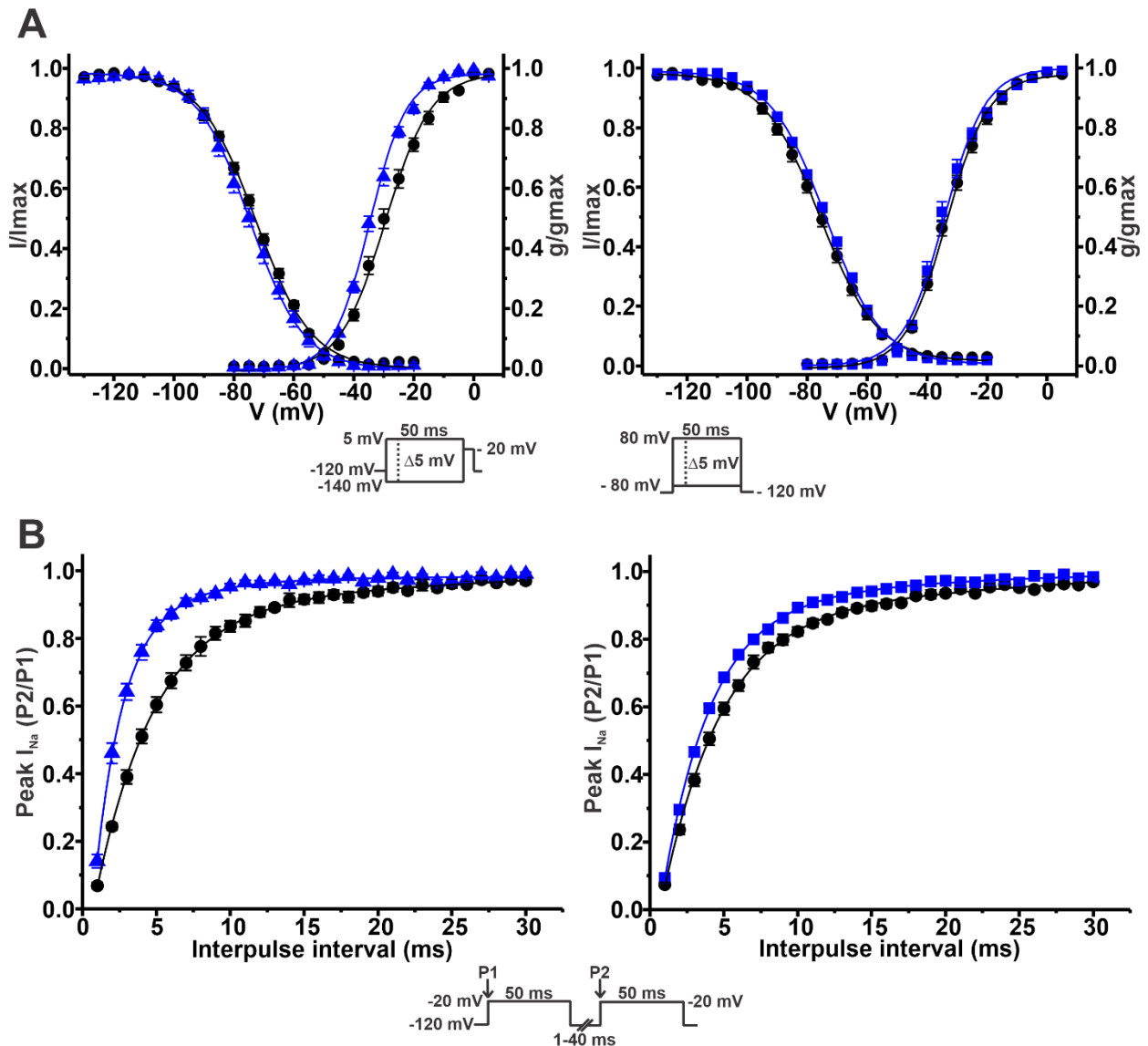

Figure 28. $\beta1^{\text{WT}}$ and $\beta1b^{\text{WT}}$ modulate $\text{Na}_v1.5$ sodium current properties. Whole cell currents were elicited by depolarizing potentials as shown in the insets. Black circles depict data for $\text{Na}_v1.5$ alone, blue triangles represent $\text{Na}_v1.5+\beta1^{\text{WT}}$ and blue squares represent $\text{Na}_v1.5+\beta1b^{\text{WT}}$. Values are expressed as mean \pm SEM. **(A)** Steady-state voltage dependence of activation and inactivation plots of the $\beta1^{\text{WT}}$ studies (left) and $\beta1b^{\text{WT}}$ studies (right). Data was fitted to a Boltzmann equation (solid lines). **(B)** Recovery from inactivation curves of the $\beta1^{\text{WT}}$ studies (left) and $\beta1b^{\text{WT}}$ studies (right). Data was fitted to a monoexponential function (solid lines).

Table 26. Biophysical parameters of HEK cells expressing Nav1.5 alone or together with $\beta 1^{WT}$ (left) or $\beta 1b^{WT}$ (right).

Parameter	$\beta 1^{WT}$		$\beta 1b^{WT}$	
	Nav1.5 alone	Nav1.5+ $\beta 1^{WT}$	Nav1.5 alone	Nav1.5+ $\beta 1b^{WT}$
Peak I_{Na} density				
pA/pF	-58.51±13.02	-99.50±12.05*	-97.44±14.91	-170.41±22.22 ^ψ
n	8	13	15	20
Activation				
$V_{1/2}$ (mV)	-29.61±1.10	-34.61±0.68*	-33.20±0.88	-34.69±0.89
k	6.95±0.06	6.40±0.14	6.80±0.26	6.14±0.28
n	6	11	15	20
Steady-state inactivation				
$V_{1/2}$ (mV)	-73.00±0.75	-74.90±1.33	-75.69±1.12	-73.71±0.62
k	9.07±0.21	8.57±0.25	9.32±0.20	9.25±0.21
n	6	11	14	18
Recovery from inactivation				
τ (ms)	4.42±0.28	2.27±0.16*	4.56±0.19	3.72±0.11 ^ψ
n	6	10	12	10

Data is presented as Mean \pm SEM. I_{Na} = sodium current; n = number of cells; k = slope factor; $V_{1/2}$ = voltage for half-maximal activation or steady-state inactivation; τ = time constant. Differences between data were analyzed with a t-test. *vs Nav1.5 ($\beta 1$); ^ψvs Nav1.5 ($\beta 1b$). Significantly different, p-value < 0.05.

2. The mutant $\beta 1^{D103V}$ subunit decreases Nav1.5 sodium current density

To determine whether the *SCN1B* SNV identified in the patient had an effect on the cardiac Nav1.5 sodium current, we performed a functional characterization in HEK-293T cells expressing Nav1.5+ $\beta 1^{D103V}$ compared to those expressing Nav1.5+ $\beta 1^{WT}$.

$\beta 1^{D103V}$ decreased Nav1.5 sodium current density by 45.7% compared to $\beta 1^{WT}$ (Figure 29B and Table 27). Also, $\beta 1^{D103V}$ induced a 3.37-mV positive shift of the voltage dependence of activation compared to $\beta 1^{WT}$ (Figure 29C and Table 27). The voltage dependence of steady state inactivation was similar in the two conditions studied (Nav1.5+ $\beta 1^{WT}$ and Nav1.5+ $\beta 1^{D103V}$) (Figure 29C and Table 27). Likewise, the recovery from inactivation time constants were similar when I_{Na} was measured in both experimental conditions (Figure 29D and Table 27).

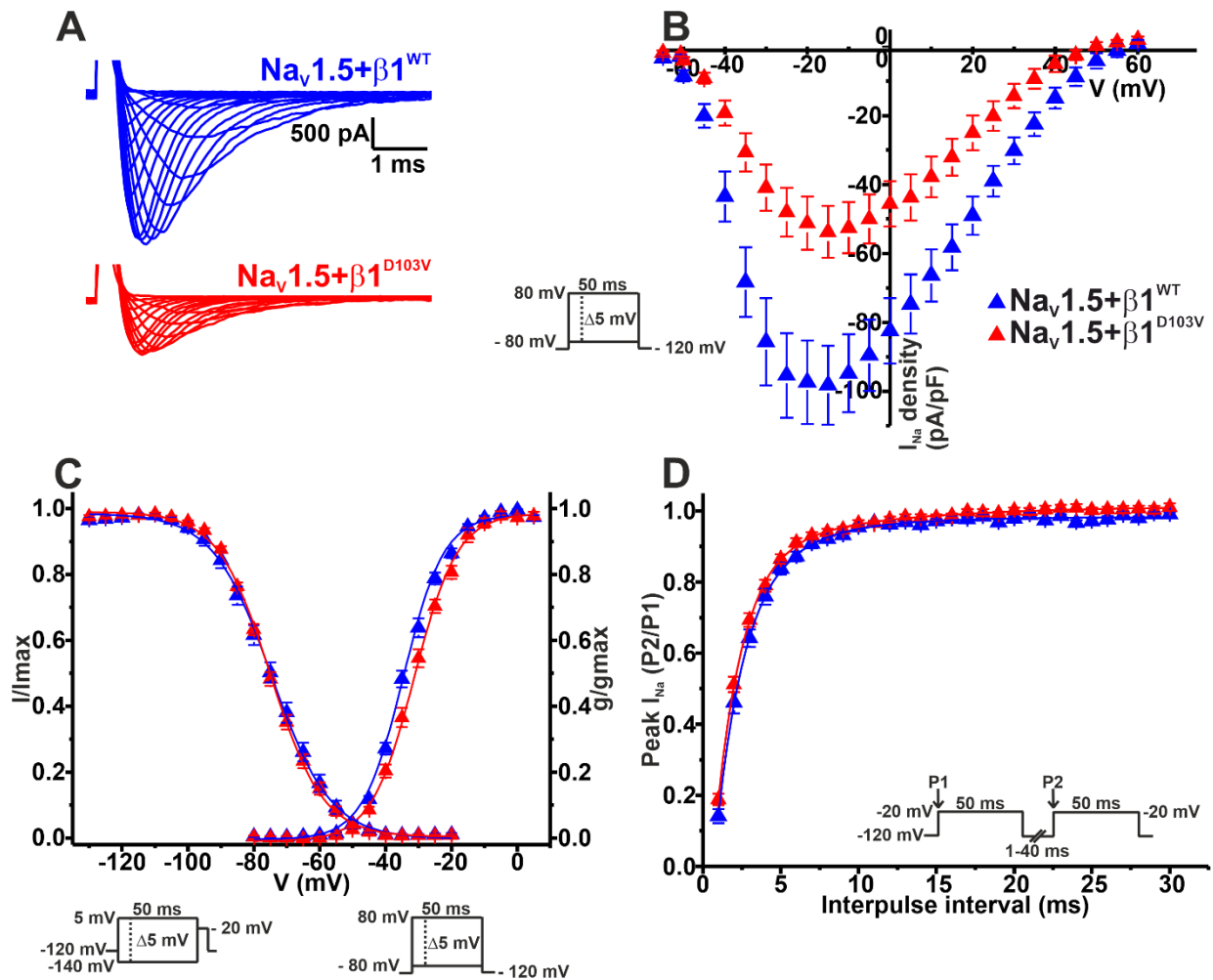

Figure 29. $\beta 1^{D103V}$ modifies the gating properties of Nav1.5 channel. Whole cell currents were elicited by depolarizing potentials as shown in the insets. Blue triangles depict data for Nav_v1.5+β1^{WT} and red triangles represent Nav_v1.5+β1^{D103V}. Values are expressed as mean ± SEM. **(A)** Representative whole cell Na⁺ current traces for Nav_v1.5+β1^{WT} (top) and Nav_v1.5+β1^{D103V} (bottom). **(B)** Mean current-voltage relationship. Peak I_{Na} amplitude was normalized by the cell capacitance to obtain Peak I_{Na} density values. **(C)** Steady-state voltage dependence of activation and inactivation plots. Data was fitted to a Boltzmann equation (solid lines). **(D)** Recovery from inactivation curves. Data was fitted to a monoexponential function (solid lines).

Table 27. Biophysical parameters of HEK cells expressing Nav1.5+β1^{WT} or Nav1.5+β1^{D103V}.

Parameter	Nav1.5+β1 ^{WT}	Nav1.5+β1 ^{D103V}
Peak I_{Na} density		
pA/pF	-99.50±12.05	-54.04±7.63*
n	13	10
Activation		
V _{1/2} (mV)	-34.61±0.68	-31.24±0.78*
k	6.40±0.14	6.52±0.24
n	11	6
Steady-state inactivation		
V _{1/2} (mV)	-74.90±1.33	-74.76±0.75
k	8.57±0.25	7.88±0.25
n	11	10
Recovery from inactivation		
τ (ms)	2.27±0.16	2.14±0.10
n	10	10

Data is presented as Mean ± SEM. I_{Na} = sodium current; n = number of cells; k = slope factor; V_{1/2} = voltage for half-maximal activation or steady-state inactivation; τ = time constant. Differences between data were analyzed with a t-test. *vs Nav1.5+β1^{WT}. Significantly different, p-value < 0.05.

Notably, we did not detect any sodium current in 34 of 75 cells transfected with Nav1.5+β1^{D103V}. However, only 11 of 81 cells expressing Nav1.5+β1^{WT} had no detectable I_{Na}. This effect on the sodium current could be prompted by either an electrical malfunction of the channel, or a decrease in total Nav1.5 protein expression in the cell and in the membrane. To assess total and membrane protein expression, we performed Western Blot analysis 48h after transfection (see **Methods 4.4.1**).

These experiments showed that the β1^{D103V} mutation did not affect total protein expression. We observed approximately the same amount of total Nav1.5 in all three conditions (Nav1.5 alone, Nav1.5+β1^{WT}, and Nav1.5+β1^{D103V}, **Figures 30A and 30C**). Moreover, immunoblotting analysis of biotinylated surface membrane proteins evidenced that the amount of Nav1.5 in the plasma membrane was unaffected by the β1 mutation (**Figures 30B and 30C**).

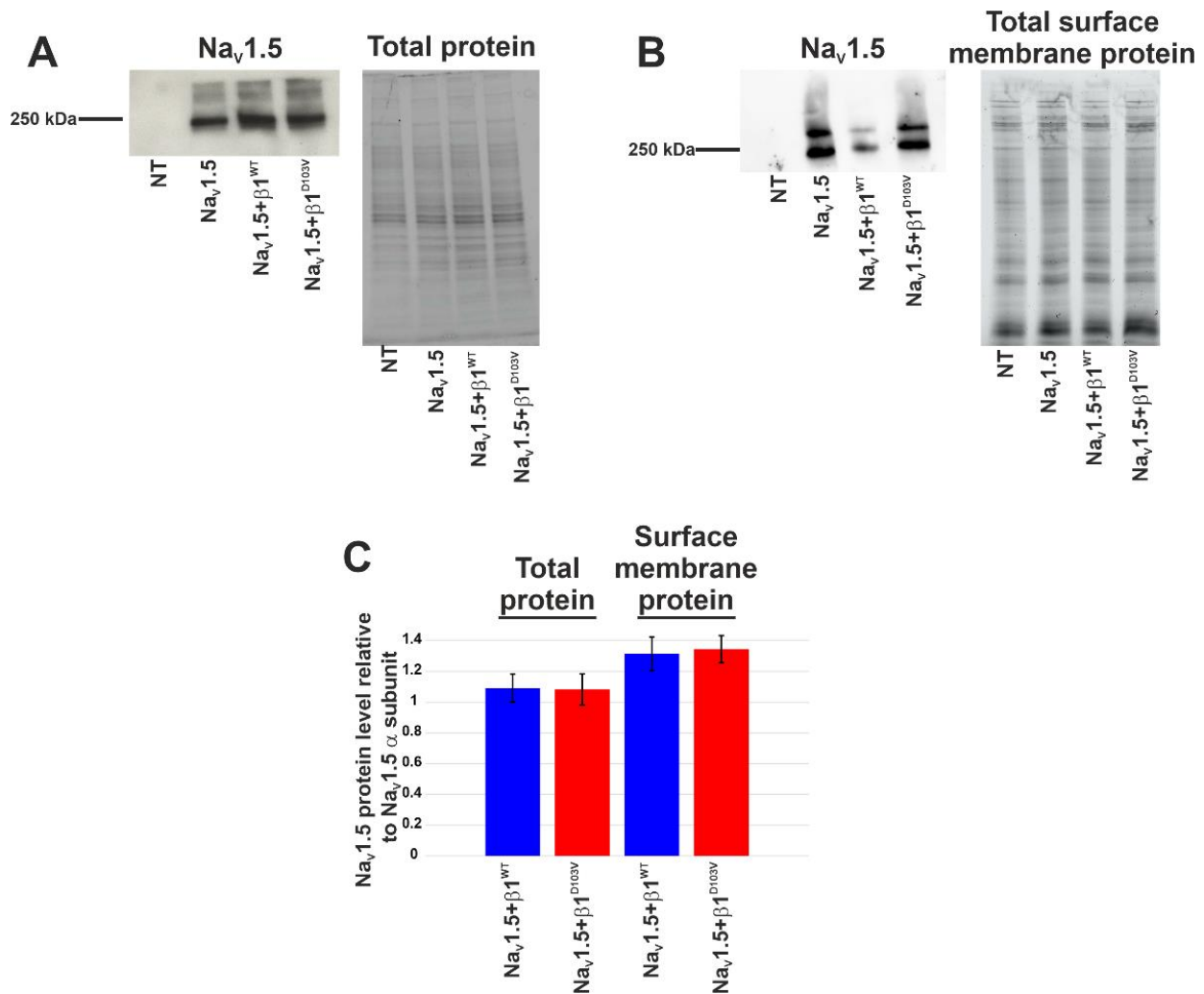

Figure 30. Na_v1.5 protein expression is not affected by β1^{D103V}. (A) Western blot detection of Na_v1.5 (left) and corresponding total protein stain-free gel (right), from HEK-293T cells transfected with either Na_v1.5, Na_v1.5+β1^{WT}, or Na_v1.5+β1^{D103V} or non-transfected cells (NT). (B) Western blot detection of Na_v1.5 after cell surface biotinylation (left) and corresponding total protein stain-free gel (right), from HEK-293T cells transfected with either Na_v1.5, Na_v1.5+β1^{WT}, or Na_v1.5+β1^{D103V} or non-transfected cells (NT). (C) Bar graph depicts the relative protein expression normalized by the Na_v1.5 α subunit protein level. Left two bars correspond to total protein (n = 2) and right two bars correspond to biotinylated protein (n = 4) from HEK-293T cells transfected with either Na_v1.5+β1^{WT} or Na_v1.5+β1^{D103V}. Both visible bands from the biotinylated samples were used for quantification, and the ratio was obtained by normalizing each condition with its respective input. Differences between data were analyzed with a t-test. Significantly different, p-value < 0.05.

3. The mutant $\beta 1b^{D103V}$ isoform does not modify $Na_v1.5$ properties

To further investigate all the possible effects of the SNV on $Na_v1.5$ current, we also evaluated the effects of the mutant $\beta 1$ alternative isoform ($\beta 1b^{D103V}$) on $Na_v1.5$ sodium current features.

We did not observe any changes in I_{Na} density from cells expressing $\beta 1b^{D103V}$ compared to $\beta 1b^{WT}$. Likewise, voltage dependence of activation, steady state inactivation, and recovery from inactivation were not altered by this mutant subunit compared to the wildtype subunit (**Figure 31** and **Table 28**).

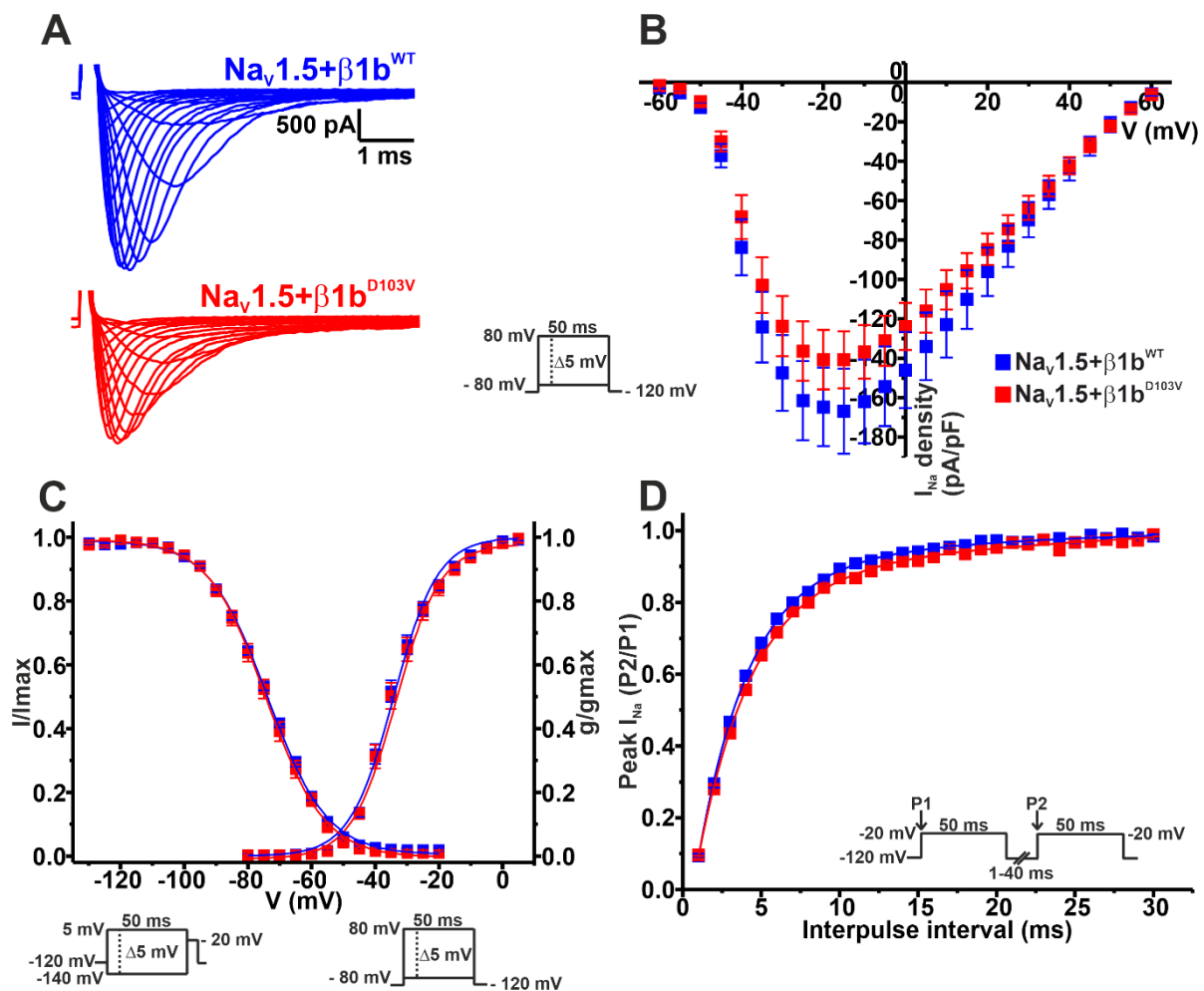

Figure 31. $Na_v1.5$ current properties are not modified by $\beta 1b^{D103V}$. Whole cell currents were elicited by depolarizing potentials as shown in the insets. Blue squares depict data for $Na_v1.5+\beta 1b^{WT}$ and red squares represent $Na_v1.5+\beta 1b^{D103V}$. Values are expressed as mean \pm SEM. **(A)** Representative whole cell Na^+ current traces from $Na_v1.5+\beta 1b^{WT}$ (top) and $Na_v1.5+\beta 1b^{D103V}$ (bottom). **(B)** Mean current-voltage relationship. Peak I_{Na} amplitude was normalized by the cell capacitance to obtain Peak I_{Na} density values. **(C)** Steady-state voltage dependence of activation and inactivation plots. Data was fitted to a Boltzmann equation (solid lines). **(D)** Recovery from inactivation curves. Data was fitted to a monoexponential function (solid lines).

Table 28. Biophysical parameters of HEK cells expressing Nav1.5+β1b^{WT} or Nav1.5+β1b^{D103V}.

Parameter	Nav1.5+β1b ^{WT}	Nav1.5+β1b ^{D103V}
Peak I_{Na} density		
pA/pF	-170.41±22.22	-143.03±14.84
n	20	14
Activation		
V _{1/2} (mV)	-34.69±0.89	-34.41±1.15
k	6.14±0.28	6.29±0.27
n	20	13
Steady-state inactivation		
V _{1/2} (mV)	-73.71±0.62	-74.21±1.16
k	9.25±0.21	8.84±0.20
n	18	10
Recovery from inactivation		
τ (ms)	3.72±0.11	4.15±0.14
n	10	8

Data is presented as Mean ± SEM. I_{Na} = sodium current; n = number of cells; k = slope factor; V_{1/2} = voltage for half-maximal activation or steady-state inactivation; τ = time constant. Differences between data were analyzed with a t-test. *vs Nav1.5+β1^{WT}. Significantly different, p-value < 0.05.

4. The β1 and β1b subunits modulate Nav1.1 sodium current properties

Because we hypothesized that the neurological features of the patient could be related to the SNV, we investigated whether the p.D130V mutation in β1 and β1b isoforms also affected one of the most predominant brain-type sodium channels: Nav1.1. Similar to the Nav1.5 experiments, the effect of the β1 on Nav1.1 sodium current properties had been studied before. However, we studied the effect of both β1 and β1b in HEK-293T cells as an internal control.

We detected a 45.9% and 47.2% increase of peak I_{Na} density when Nav1.1 was co-expressed with β1^{WT} or β1b^{WT}, respectively, compared to Nav1.1 alone (**Figure 32B** and **Table 29**).

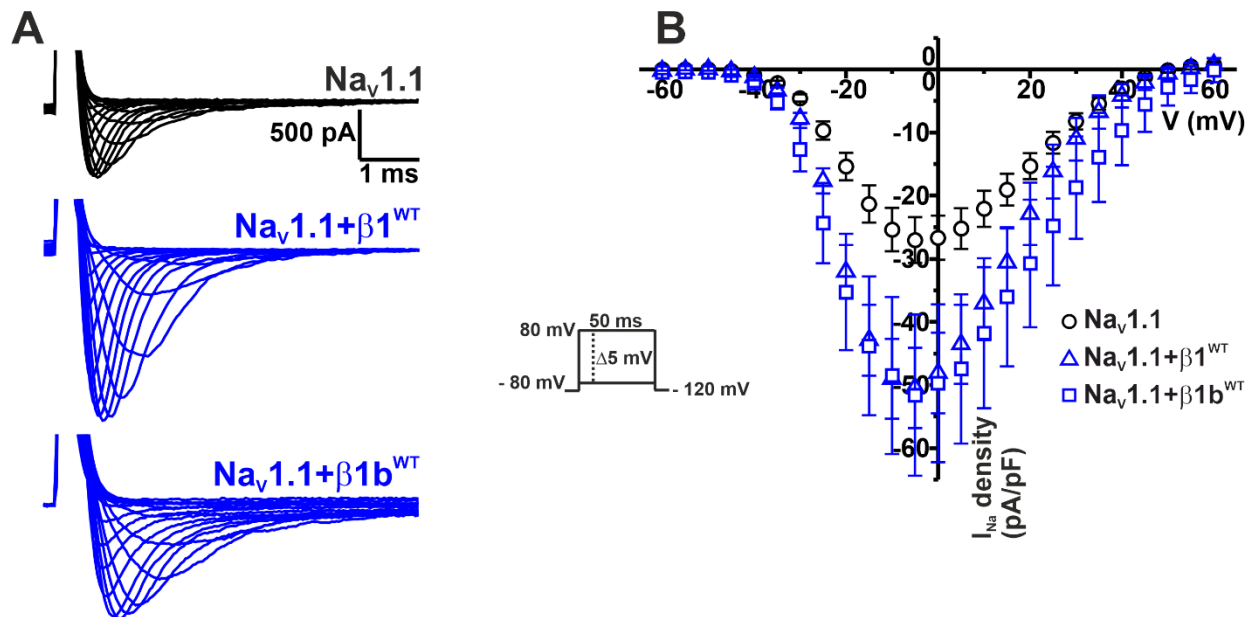

Figure 32. $\beta 1^{WT}$ and $\beta 1b^{WT}$ increase $Na_v1.1$ sodium current density. Whole cell currents were elicited by depolarizing potentials as shown in the insets. Black open circles depict data for $Na_v1.1$ alone, blue open triangles represent $Na_v1.1+\beta 1^{WT}$ and blue open squares represent $Na_v1.1+\beta 1b^{WT}$. Values are expressed as mean \pm SEM. **(A)** Representative whole cell Na^+ current traces from $Na_v1.1$ (top), $Na_v1.1+\beta 1^{WT}$ (middle) and $Na_v1.1+\beta 1b^{WT}$ (bottom). **(B)** Mean current-voltage relationship. Peak I_{Na} amplitude was normalized by the cell capacitance to obtain Peak I_{Na} density values.

Neither $\beta 1^{WT}$ nor $\beta 1b^{WT}$ caused any significant changes in the voltage dependence of activation (**Figure 33A** and **Table 29**). Steady-state inactivation of the $Na_v1.1$ current was not altered by $\beta 1^{WT}$. On the contrary, co-expression of the $\beta 1b^{WT}$ isoform caused a 7.21 mV negative shift of the voltage dependence of inactivation compared to $Na_v1.1$ alone (**Figure 33A** and **Table 29**). $\beta 1^{WT}$ markedly decreased the recovery from inactivation time in comparison to $Na_v1.1$ alone. However, this decrease was not observed when $Na_v1.1$ was co-expressed with $\beta 1b^{WT}$ (**Figure 33B** and **Table 29**).

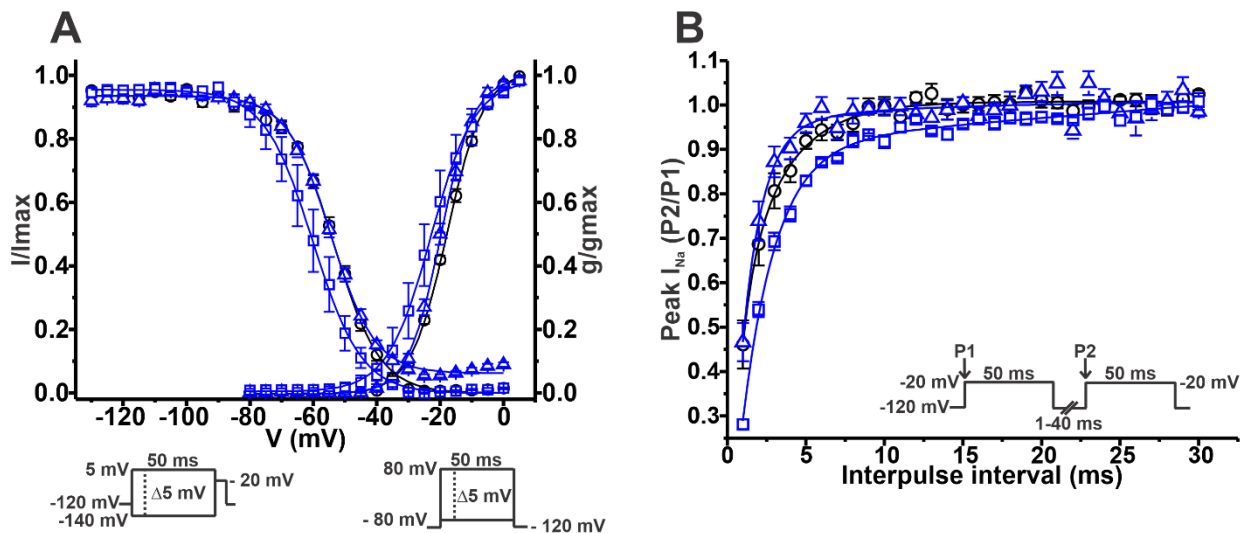

Figure 33. $\beta 1^{\text{WT}}$ and $\beta 1^{\text{b}}$ differently modulate Nav1.1 sodium current properties. Whole cell currents were elicited by depolarizing potentials as shown in the insets. Black open circles depict data for Nav1.1 alone, blue open triangles represent Nav1.1+ $\beta 1^{\text{WT}}$ and blue open squares represent Nav1.1+ $\beta 1^{\text{b}}$. Values are expressed as mean \pm SEM. **(A)** Steady-state voltage dependence of activation and inactivation plots. Data was fitted to a Boltzmann equation (solid lines). **(B)** Recovery from inactivation curves. Data was fitted to a monoexponential function (solid lines).

Table 29. Biophysical parameters of HEK cells expressing Nav1.1 alone or together with $\beta 1^{\text{WT}}$ or $\beta 1^{\text{b}}$.

Parameter	Nav1.1 alone	Nav1.1+ $\beta 1^{\text{WT}}$	Nav1.1+ $\beta 1^{\text{b}}$
Peak I_{Na} density			
pA/pF	-27.39 \pm 3.55	-50.67 \pm 6.38*	-51.90 \pm 12.75*
n	13	14	5
Activation			
V _{1/2} (mV)	-17.71 \pm 0.41	-19.69 \pm 0.67	-22.78 \pm 2.91
k	5.79 \pm 0.19	5.24 \pm 0.14	6.05 \pm 0.45
n	7	9	5
Steady-state inactivation			
V _{1/2} (mV)	-52.93 \pm 0.80	-54.17 \pm 0.73	-60.14 \pm 2.98*
k	7.21 \pm 0.31	7.28 \pm 0.38	6.75 \pm 0.42
n	7	9	6
Recovery from inactivation			
τ (ms)	2.30 \pm 0.12	1.31 \pm 0.26*	3.17 \pm 0.52
n	6	7	5

Data is presented as Mean \pm SEM. I_{Na} = sodium current; n = number of cells; k = slope factor; V_{1/2} = voltage for half-maximal activation or steady-state inactivation; τ = time constant. Differences between data were analyzed with a t-test. *vs Nav1.1 alone. Significantly different, p-value < 0.05.

5. The $\beta 1^{D103V}$ subunit decreases $\text{Na}_v1.1$ current density

To determine whether the *SCN1B* SNV identified in the patient had an effect on the neuronal $\text{Na}_v1.1$ sodium current, we first performed functional characterization in HEK-293T cells expressing $\text{Na}_v1.1+\beta 1^{D103V}$ compared to those expressing $\text{Na}_v1.1+\beta 1^{\text{WT}}$.

Peak current density measured from cells expressing $\text{Na}_v1.1+\beta 1^{D103V}$ was 66.9% smaller than that in $\text{Na}_v1.1+\beta 1^{\text{WT}}$ -expressing cells (**Figure 34B** and **Table 30**). Voltage dependence of activation and steady-state inactivation were not altered by $\beta 1^{D103V}$ (**Figure 34C** and **Table 30**). Recovery from inactivation time constants were similar in both experimental conditions (**Figure 34D** and **Table 30**).

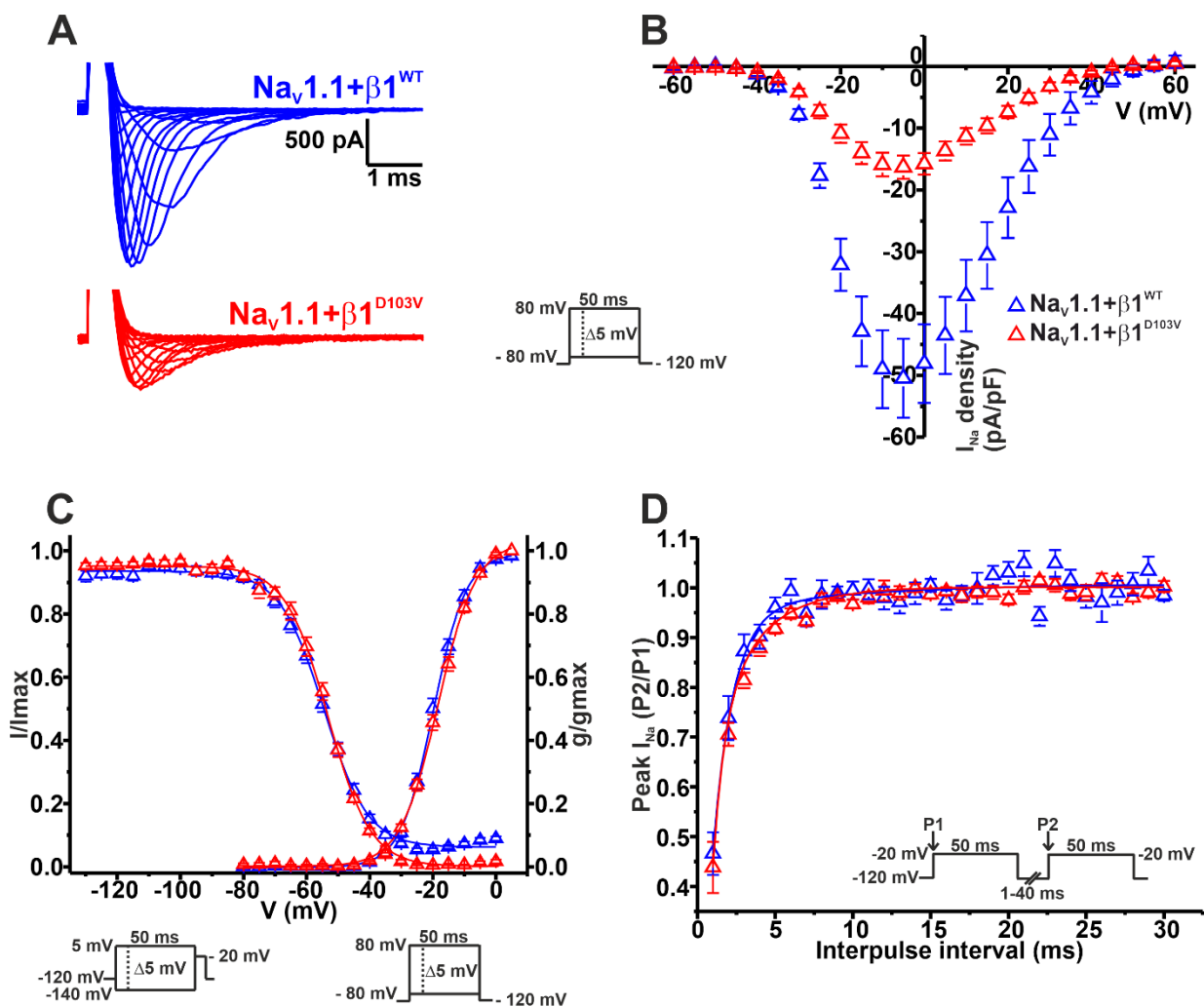

voltage dependence of activation and inactivation plots. Data was fitted to a Boltzmann equation (solid lines). (D) Recovery from inactivation curves. Data was fitted to a monoexponential function (solid lines).

Table 30. Biophysical parameters of HEK cells expressing Nav1.1+β1^{WT} or Nav1.1+β1^{D103V}.

Parameter	Nav1.1+β1 ^{WT}	Nav1.1+β1 ^{D103V}
Peak I_{Na} density		
pA/pF	-50.67±6.38	-16.76±1.88*
n	14	22
Activation		
V _{1/2} (mV)	-19.69±0.67	-18.18±0.61
k	5.24±0.14	5.91±0.21
n	9	13
Steady-state inactivation		
V _{1/2} (mV)	-54.17±0.73	-53.06±0.34
k	7.28±0.38	7.09±0.54
n	9	13
Recovery from inactivation		
τ (ms)	1.31±0.26	1.79±0.18
n	7	7

Data is presented as Mean ± SEM. I_{Na} = sodium current; n = number of cells; k = slope factor; V_{1/2} = voltage for half-maximal activation or steady-state inactivation; τ = time constant. Differences between data were analyzed with a t-test. *vs Nav1.1+β1^{WT}. Significantly different, p-value < 0.05.

Similar to what we observed in Nav1.5 experiments, we did not detect any current in 23 out of 59 cells expressing Nav1.1+β1^{D103V}. However, when cells were transfected with Nav1.1+β1^{WT}, only 4 of 56 cells showed no current. Western blot analysis showed no significant differences in Nav1.1 expression between the three experimental conditions (**Figure 35**).

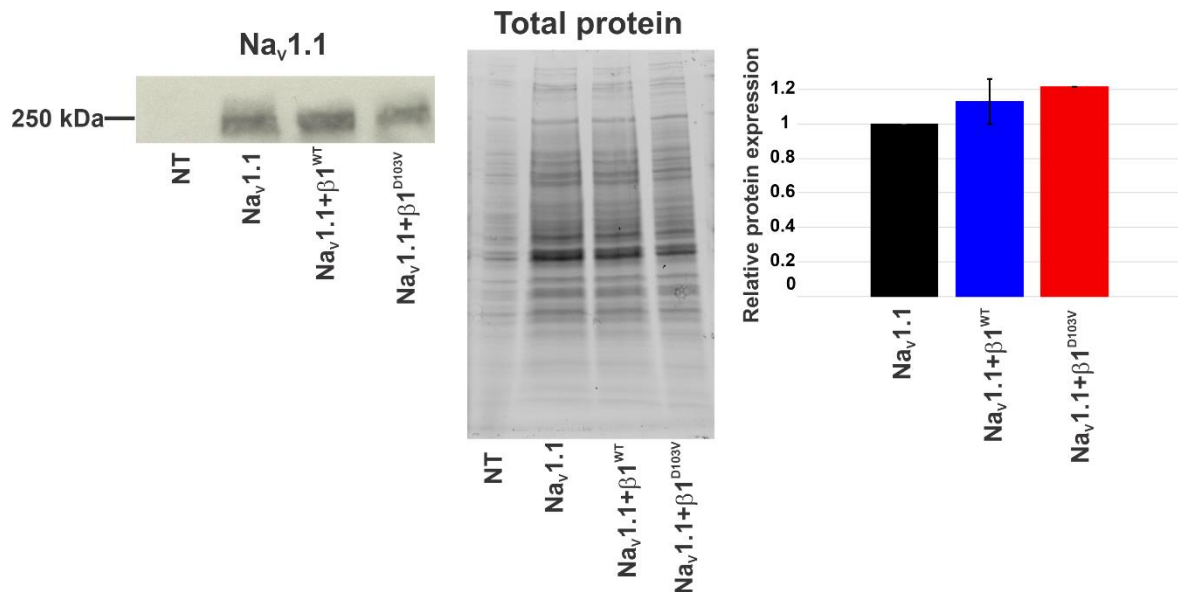

Figure 35. Nav_v1.1 protein expression is not affected by β1^{D103V}. Western blot detection of Nav_v1.1 (left) and corresponding total protein stain-free gel (middle) from HEK-293T cells transfected with either Nav_v1.1, Nav_v1.1+β1^{WT}, or Nav_v1.1+β1^{D103V} or non-transfected cells (NT). Bar graph on the right depicts the relative protein expression normalized by Nav_v1.1 alone (n = 2). Differences between data were analyzed with a t-test. Significantly different, p-value < 0.05.

6. Mutant β1 isoform b (β1b^{D103V}) modifies Nav_v1.1 properties

Because the p.D103V mutation is located in a region shared by both β1 and β1b subunits, we also assessed the effect of β1b^{D103V} on Nav_v1.1 current properties.

Co-expression of β1b^{D103V} with Nav_v1.1 did not change I_{Na} density compared to Nav_v1.1+β1b^{WT} (**Figure 36B** and **Table 31**). Likewise, the β1b^{D103V} subunit did not significantly change the voltage dependence of activation compared to β1b^{WT} (**Figure 36C** and **Table 31**). However, β1b^{D103V} caused a 6.04-mV right shift of the voltage dependence of steady-state inactivation when compared to the wildtype subunit (**Figure 36C** and **Table 31**). This change resulted in a positive shift of the window current of Nav_v1.1+β1b^{D103V} compared to Nav_v1.1+β1b^{WT} (**Figure 36D**). β1b^{D103V} significantly reduced the recovery from inactivation time constant compared to Nav_v1.1+β1b^{WT} (**Figure 36E** and **Table 31**).

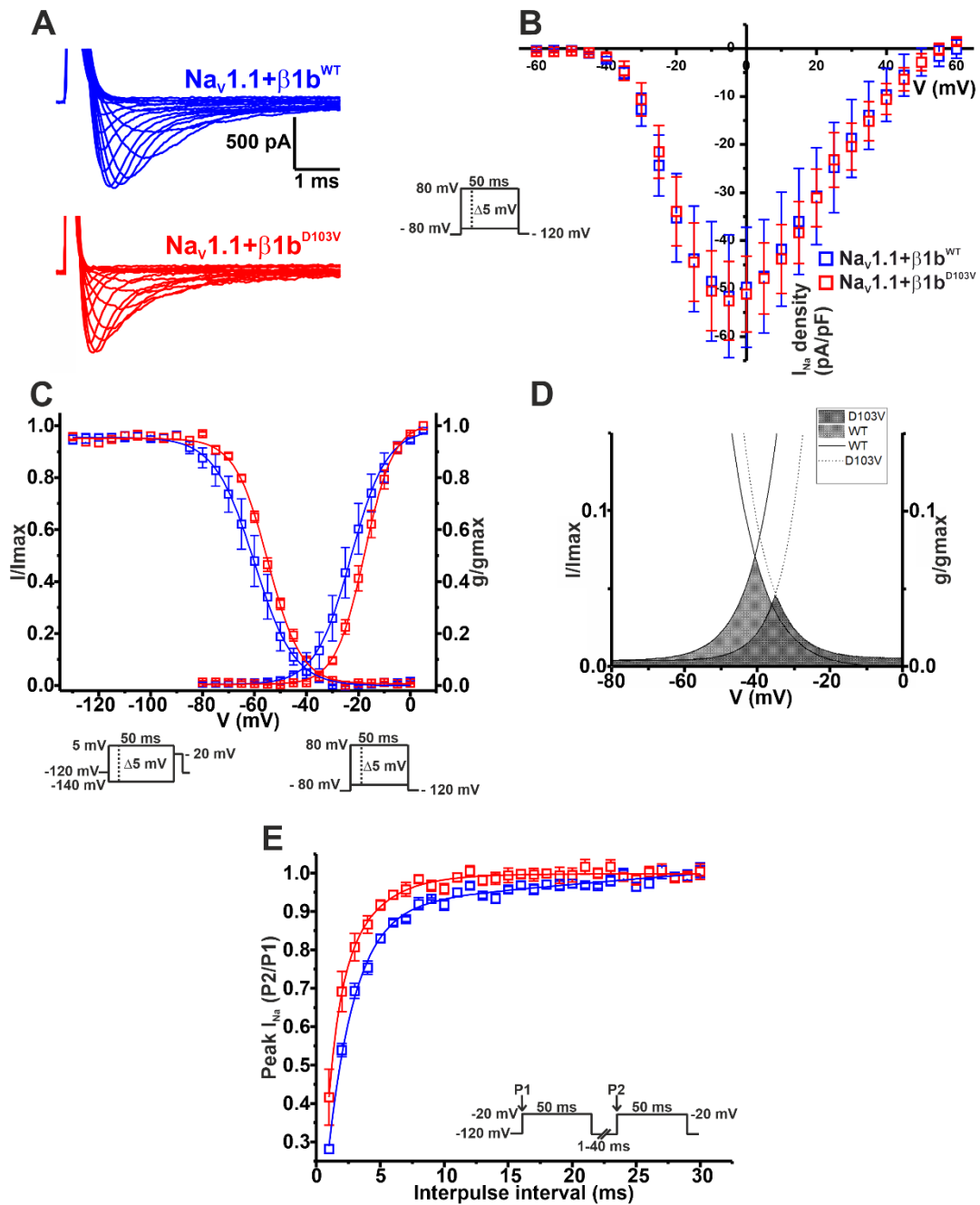

Figure 36. $\beta1b^{\text{D103V}}$ modifies the gating properties of $\text{Na}_v1.1$ channel. Whole cell currents were elicited by depolarizing potentials as shown in the insets. Blue squares depict data for $\text{Na}_v1.1+\beta1b^{\text{WT}}$ and red squares represent $\text{Na}_v1.1+\beta1b^{\text{D103V}}$. Values are expressed as mean \pm SEM. **(A)** Representative whole cell Na^+ current traces from $\text{Na}_v1.1+\beta1b^{\text{WT}}$ (top) and $\text{Na}_v1.1+\beta1b^{\text{D103V}}$ (bottom). **(B)** Mean current-voltage relationship. Peak I_{Na} amplitude was normalized by the cell capacitance to obtain Peak I_{Na} density values. **(C)** Steady-state voltage dependence of activation and inactivation plots. Data was fitted to a Boltzmann equation (solid lines). **(D)** Window region bounded by the activation and steady state inactivation voltage dependent curves ($\text{Na}_v1.1+\beta1b^{\text{WT}}$ light gray and $\text{Na}_v1.1+\beta1b^{\text{D103V}}$ dark gray). **(E)** Recovery from inactivation curves. Data was fitted to a monoexponential function (solid lines).

Table 31. Biophysical parameters of HEK cells expressing Nav1.1+β1b^{WT} or Nav1.1+β1b^{D103V}.

Parameter	Nav1.1+β1b ^{WT}	Nav1.1+β1b ^{D103V}
Peak I_{Na} density		
pA/pF	-51.90±12.75	-54.06±8.41
n	5	9
Activation		
V _{1/2} (mV)	-22.78±2.91	-17.34±1.16
k	6.05±0.45	5.36±0.30
n	5	8
Steady-state inactivation		
V _{1/2} (mV)	-60.14±2.98	-54.10±0.82*
k	6.75±0.42	6.36±0.29
n	6	7
Recovery from inactivation		
τ (ms)	3.17±0.52	1.67±0.23*
n	5	6

Data is presented as Mean ± SEM. I_{Na} = sodium current; n = number of cells; k = slope factor; V_{1/2} = voltage for half-maximal activation or steady-state inactivation; τ = time constant. Differences between data were analyzed with a t-test. *vs Nav1.1+β1b^{WT}. Significantly different, p-value < 0.05.

Study 2: *SCN5A* variant associated with Brugada Syndrome

As explained in the **Rationale of the research section**, we were also interested in studying the effects of an SNV that had been previously related to BrS (*SCN5A*_c.4573G>A). We hypothesized that the SNV modifies the sodium current properties of the Nav1.5 channel. To assess this, we used two cellular approaches. First, we studied HEK-293T cells transiently transfected with the SNV. This allowed us to determine the changes in the sodium current properties induced by the SNV. However, we were also interested in approaching the effect of patient-specific genetic background over the sodium current properties, in a cardiomyocyte-like cellular environment. For that purpose, we obtained skin samples of four individuals of the same family, three of which were carriers of the SNV (**Figure 37**). We reprogrammed their dermal fibroblasts into iPSc, and studied the electrophysiological properties of the iPSc-CM of these four individuals. From now on the father, which is a related control, will be referenced as Rb20237, the mother as Rb20236, the daughter as Rb20234 and the son as Rb20235.

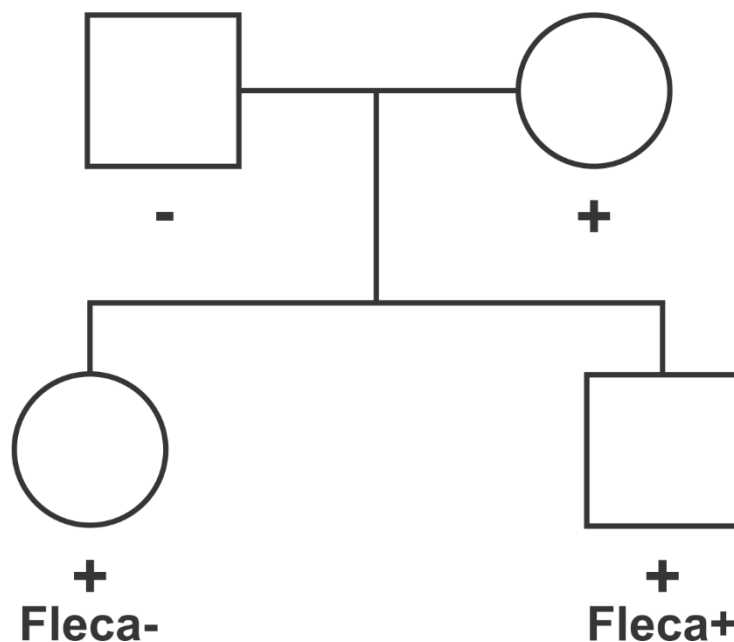

Figure 37. Partial pedigree of the family carrying the *SCN5A* SNV, showing the individuals from whose we obtained skin samples. Circles represent females, and squares represent males. The + symbol represents SNV carriers, and – symbol the non-carriers. Fleca designates patients which underwent a flecainide test, and the + or – symbols next to it indicates whether the result was positive or negative, respectively.

1. Characterization of the SNV *SCN5A_c.4573G>A* in HEK-293T cells

Before studying the mutation in patient-specific iPSC-CM, we characterized the effect of the SNV *SCN5A_c.4573G>A* on the electrophysiological properties of the $\text{Na}_v1.5$ sodium current in HEK-293T cells transiently transfected with a vector encoding the *SCN5A* SNV.

We used the pcDNA3-*SCN5A* vector as a template to introduce the SNV by site-directed mutagenesis. We sequenced the vector to ensure the presence of the SNV under study (**Figure 38**) and the absence of additional variants.

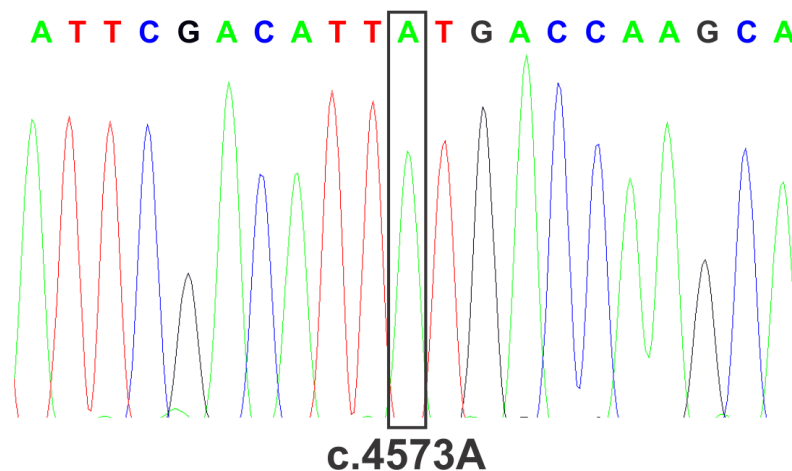

Figure 38. Region of the pcDNA3.1-*SCN5A* vector harboring the SNV *SCN5A_c.4573G>A*. The SNV *SCN5A_c.4573G>A* was identified in the pcDNA3.1-*SCN5A* mutated vector.

We transiently transfected HEK-293T cells with a GFP vector and either one of the vectors encoding $\text{Na}_v1.5^{\text{WT}}$ (homozygous WT cells), or $\text{Na}_v1.5^{\text{V1525M}}$ (homozygous V1525M cells) or with both vectors (heterozygous WT/V1525M cells). We recorded sodium currents using the whole cell configuration of the patch clamp technique, as previously explained.

As shown in **Figure 39B** and **Table 32**, the SNV markedly decreased I_{Na} density. In the cells where the SNV was expressed in homozygosis, the decrease in I_{Na} density compared to the WT was of 46.9%. As expected, the decrease in I_{Na} in heterozygosis (24.2%) was near half of the reduction we observed in homozygosis.

Using the same I-V pulse protocol, we measured the inactivation time constant at different voltages of fifteen randomly selected cells out of the total. We fitted the data to a double exponential function, obtaining two time constants: τ fast and τ slow.

We did not detect any significant changes in τ fast, with respect to the WT, when the SNV was expressed in heterozygosity or homozygosity. However, τ slow was slightly increased at 20 mV when the SNV was expressed in heterozygosity (identified with the symbol *), compared to the WT (Figure 39C).

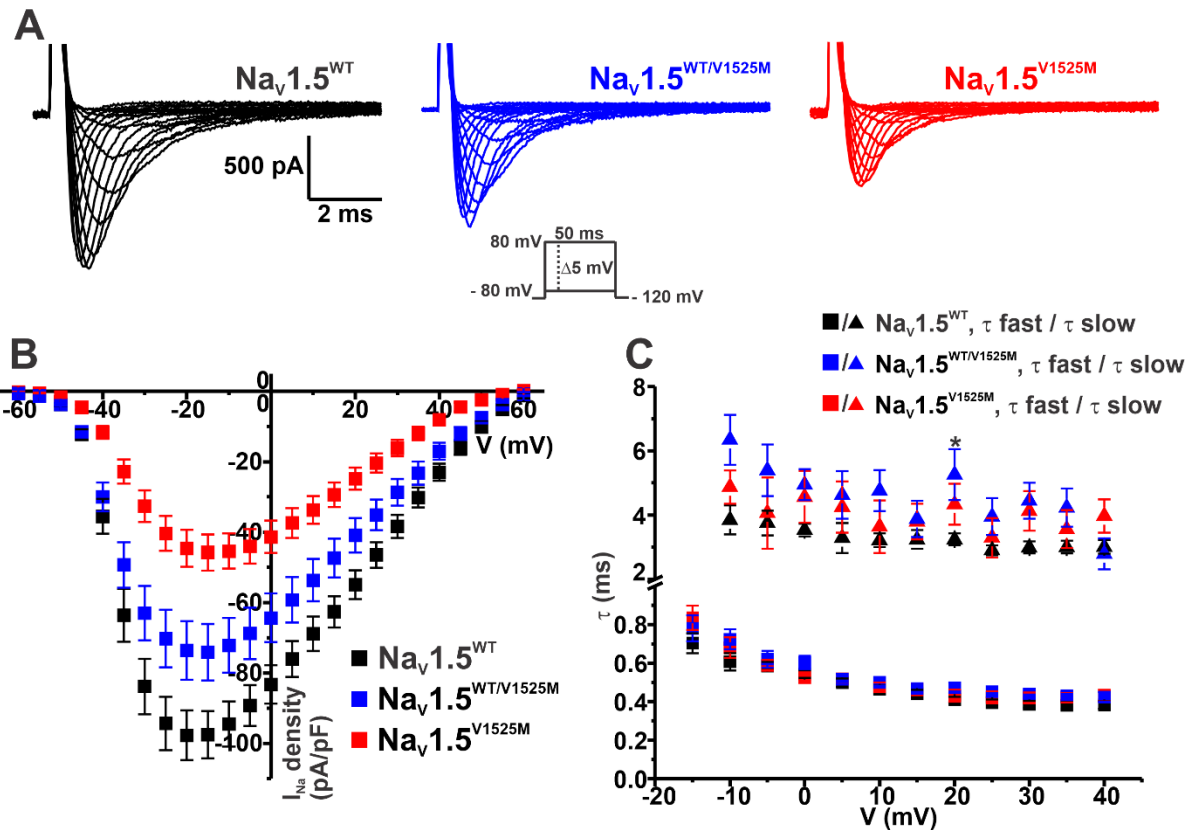

Figure 39. The SNV *SCN5A*_c.4573G>A decreases $\text{Na}_v1.5$ peak I_{Na} . Whole cell currents were elicited by depolarizing potentials as shown in the insets. Black squares depict data for $\text{Na}_v1.5^{\text{WT}}$, blue squares represent $\text{Na}_v1.5^{\text{WT}/\text{V1525M}}$ and red squares represent $\text{Na}_v1.5^{\text{V1525M}}$. Values are expressed as mean \pm SEM. **(A)** Representative whole cell Na^+ current traces from $\text{Na}_v1.5^{\text{WT}}$ (left), $\text{Na}_v1.5^{\text{WT}/\text{V1525M}}$ (middle) and $\text{Na}_v1.5^{\text{V1525M}}$ (right). **(B)** Mean current-voltage relationship. Peak I_{Na} amplitude was normalized by the cell capacitance to obtain Peak I_{Na} density values. **(C)** I_{Na} inactivation plot. τ fast and slow values were plotted against voltage. Squares depict data for τ fast, and triangles for τ slow. Differences between data were analyzed with a t-test. *vs $\text{Na}_v1.5^{\text{WT}}$. Significantly different, p -value < 0.05 .

The voltage dependence of activation curve was shifted towards more depolarizing potentials when the SNV was expressed in homozygosity, but not in heterozygosity, compared to the WT (Figure 40A and Table 32). No significant changes were observed in the steady-state inactivation parameters (Figure 40A and Table 32).

Surprisingly, the recovery from inactivation time constant was only increased when the SNV was expressed in heterozygosis, compared to the WT (**Figure 40B** and **Table 32**).

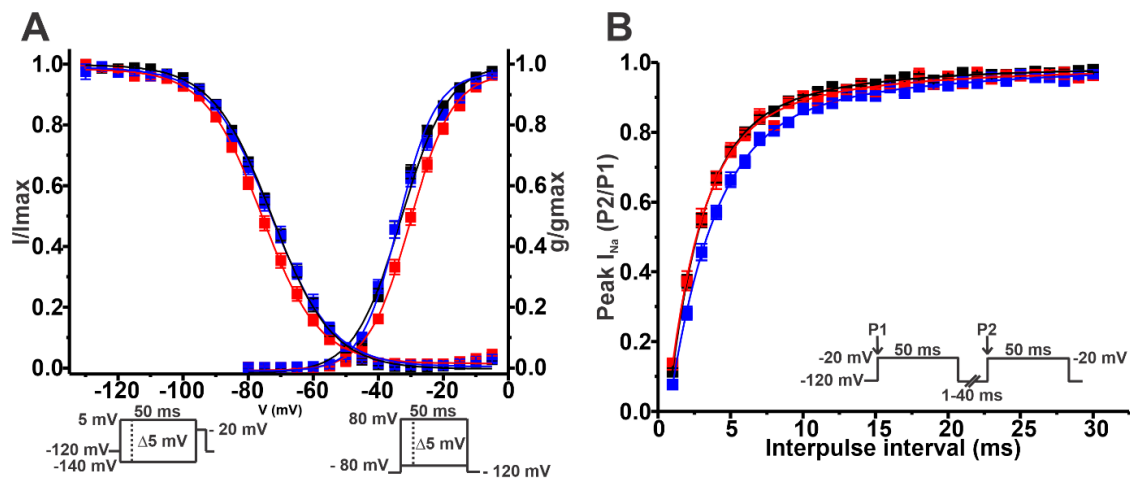

Figure 40. The homozygous and heterozygous expression of *SCN5A_c.4573G>A* have different effects in $\text{Na}_v1.5$ sodium current properties. Whole cell currents were elicited by depolarizing potentials as shown in the insets. Black squares depict data for $\text{Na}_v1.5^{\text{WT}}$, blue squares represent $\text{Na}_v1.5^{\text{WT}/\text{V1525M}}$ and red squares represent $\text{Na}_v1.5^{\text{V1525M}}$. Values are expressed as mean \pm SEM. **(A)** Voltage dependence of activation and steady-state inactivation plots. Data was fitted to a Boltzmann equation (solid lines). **(B)** Recovery from inactivation curves. Data was fitted to a monoexponential function (solid lines).

Table 32. Biophysical parameters of HEK-293T cells expressing $\text{Na}_v1.5^{\text{WT}}$, $\text{Na}_v1.5^{\text{WT}/\text{V1525M}}$ or $\text{Na}_v1.5^{\text{V1525M}}$.

Parameter	$\text{Na}_v1.5^{\text{WT}}$	$\text{Na}_v1.5^{\text{WT}/\text{V1525M}}$	$\text{Na}_v1.5^{\text{V1525M}}$
Peak I_{Na} density			
pA/pF	-97.67 ± 7.09	$-74.07 \pm 8.04^*$	$-45.77 \pm 5.18^{*\ddagger}$
n	23	28	19
Activation			
$V_{1/2}$ (mV)	-33.60 ± 0.63	-33.10 ± 0.78	$-30.01 \pm 0.68^{*\ddagger}$
k	5.49 ± 0.21	$6.26 \pm 0.25^*$	$6.37 \pm 0.18^*$
n	23	28	19
Steady-state inactivation			
$V_{1/2}$ (mV)	-72.07 ± 0.87	-72.23 ± 1.19	-74.90 ± 0.91
k	8.81 ± 0.24	8.89 ± 0.17	8.36 ± 0.27
n	17	22	17
Recovery from inactivation			
τ (ms)	2.48 ± 0.18	$3.34 \pm 0.22^{*\psi}$	2.44 ± 0.23
n	13	17	13

Data is presented as Mean \pm SEM. I_{Na} = sodium current; n = number of cells; $V_{1/2}$ = voltage for half-maximal activation or steady-state inactivation; k = slope factor; τ = time constant. Differences between data were analyzed with a one-way ANOVA with a post-hoc Tukey test. *vs $\text{Na}_v1.5^{\text{WT}}$; \ddagger vs $\text{Na}_v1.5^{\text{WT}/\text{V1525M}}$; ψ vs $\text{Na}_v1.5^{\text{V1525M}}$. Significantly different, p-value < 0.05.

Given the noteworthy loss of function observed in I_{Na} when the SNV was expressed both in heterozygosis and in homozygosis, we wanted to rule out that the WT and the mutant $Na_v1.5$ expressed differently in the transfected cells. To assess that, we performed western blot analysis 48h after transfection.

One representative experiment is shown in **Figure 41**. Of note, total $Na_v1.5$ protein expression was not decreased when the SNV was expressed heterozygously ($Na_v1.5^{WT/V1525M}$) or homozygously ($Na_v1.5^{V1525M}$). Thus, a lower expression level does not explain the I_{Na} decrease observed in these cells.

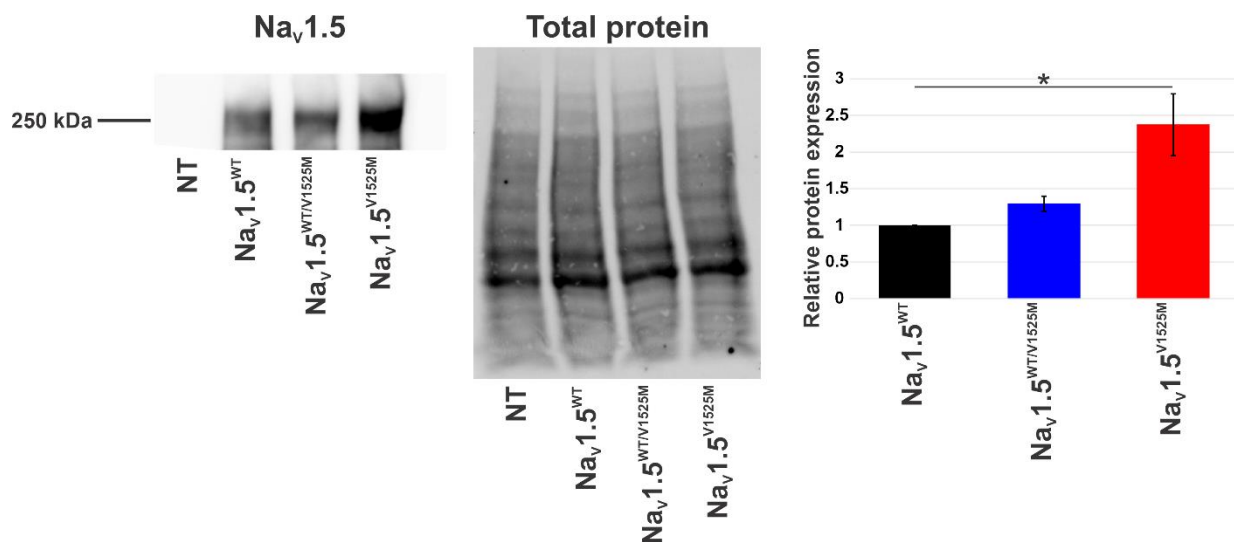

Figure 41. $Na_v1.5$ protein expression was not decreased in cells transfected with the vectors carrying the SNV. Western blot detection of $Na_v1.5$ (left) and corresponding total protein stain-free blot (middle), from HEK-293T cells transfected with either $Na_v1.5^{WT}$, $Na_v1.5^{WT/V1525M}$, or $Na_v1.5^{V1525M}$ or non-transfected cells (NT). Bar graph on the right depicts the relative protein expression normalized by $Na_v1.5^{WT}$ ($n = 3$). Differences between data were analyzed with a t-test. *vs $Na_v1.5^{WT}$. Significantly different, p -value < 0.05.

2. Generation of iPS cell lines

Based on the evidence for a loss of sodium current function of the mutant $\text{Na}_v1.5$ in heterologous conditions, and with aim to study the effects of the SNV in a more cardiomyocyte-like cellular environment carrying the patient-specific genetic background, we pursued with the patient-specific iPSc studies. As stated previously, the SNV *SCN5A*_c.4573G>A has been associated to BrS and is carried in heterozygosity by several members of the family under study.

We successfully obtained fibroblasts from skin samples of the four members of the family under study (**Figure 42A**). We sequenced the *SCN5A* coding region of the four individual's fibroblasts to confirm the presence of *SCN5A*_c.4573G>A in the SNV carriers (Rb20234, Rb20235, Rb20236), and the absence of the SNV in the non-carrier Rb20237 (related control) (**Figure 42B**).

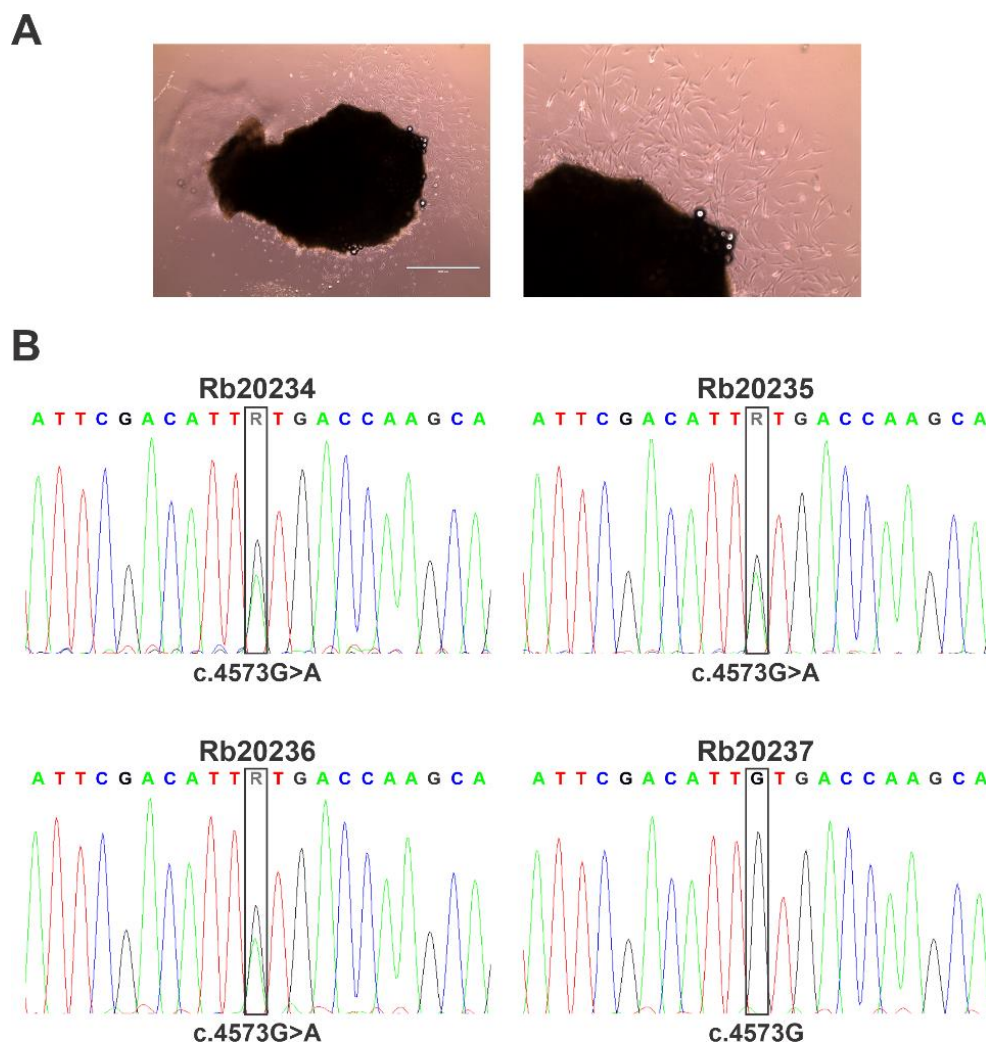

Figure 42. Sequences of the *SCN5A* region harboring the SNV from the fibroblasts of the 4 family members. (A) Left: Representative bright field microscopy image of fibroblasts in culture growing from a skin sample (dark area). Scale bar represents 1000 μm . **Right:** Magnification of the upper right section

of left image. **(B)** The SNV *SCN5A_c.4573G>A* was identified in genomic DNA isolated from fibroblasts in individuals Rb20234 (top left), Rb20235 (top right) and Rb20236 (bottom left), but not in individual Rb20237 (bottom right).

By day 26-28 after skin plating, fibroblasts were ready to be reprogrammed to iPS cells following the protocol explained in **Methods section 3.3**. iPS cell-like colonies appeared around day 20 after reprogramming, and were manually picked and treated as individual clones.

2.1. Clone selection

To obtain consistent molecular biology and electrophysiological results, we selected two clones for each patient. To select these clones, we used as a reference a non-related control iPS cell line (GPG1) that was previously generated in the laboratory. We first characterized the pluripotency transcription factors expression of this control. As shown in **Figure 43** and **Annex Table 4**, the pluripotency markers *Nanog*, *Sox-2* and *POU5F1* (encoding Oct-4) were widely overexpressed in the GPG1 iPS cells compared to the fibroblasts from the same individual.

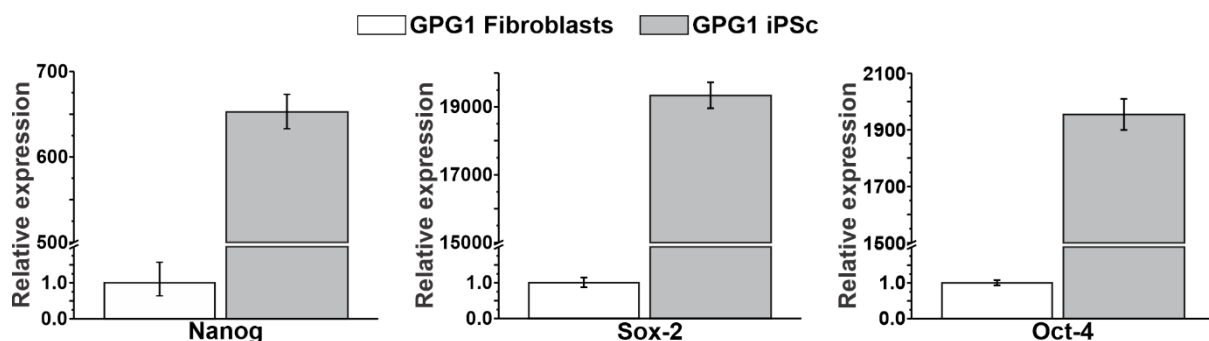

Figure 43. The non-related control GPG1 iPSc overexpresses pluripotency transcription factors compared to the fibroblasts from the same individual. The relative expression of pluripotency transcription factors *Nanog* (left), *Sox-2* (middle) and *Oct-4* (right) is shown as mean values of biological triplicates \pm minimum and maximum relative quantification.

This cell line was further characterized at Centre De Medicina Regenerativa de Barcelona (CMRB) and this comprehensive characterization confirmed the suitability of these cells as an iPSc control (data not shown).

To choose which clones to select among the newly generated iPSc clones, we checked which of them expressed pluripotency markers at a similar level as GPG1 iPSc.

We selected the two iPSc clones for each of the individuals under study that showed the most similar levels of the transcription factors compared to the non-related control. Results obtained for the two clones from a representative patient are depicted in **Figure 44**, and all the relative quantification values of the chosen clones are defined in **Table 33**. The relative levels of the pluripotency transcription factors of the discarded clones can be found in the **Annex Tables 5-8**.

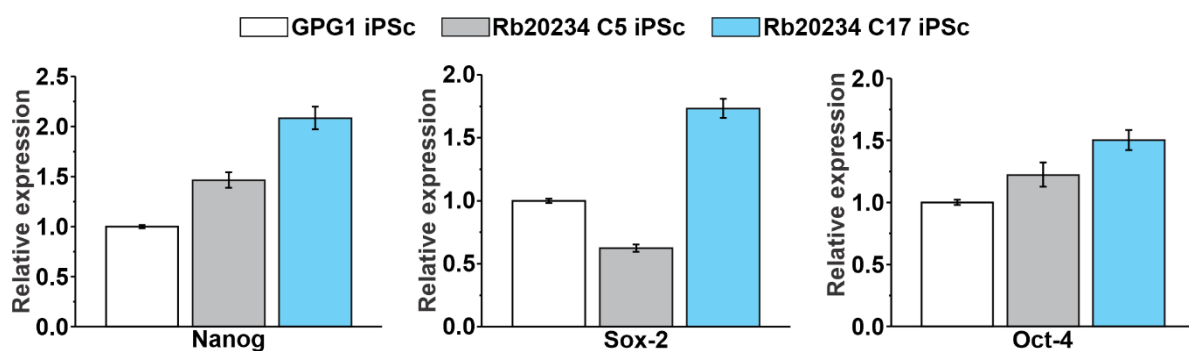

Figure 44. Bar graph of two representative selected clones, showing that they display expression levels of the pluripotency transcription factors that are similar to those of the non-related control. The relative expression of pluripotency transcription factors Nanog (left), Sox-2 (middle) and Oct-4 (right) is shown as mean values of biological triplicates \pm minimum and maximum relative quantification.

Table 33. Expression levels of the pluripotency transcription factors obtained by relative quantification (Rq) of the selected clones for each individual of the family under study with respect to the non-related control iPSc.

Individual	Selected clones	Nanog			Sox-2			Oct-4		
		Rq	Rq min	Rq max	Rq	Rq min	Rq max	Rq	Rq min	Rq max
Rb20234	C5	1.463	1.389	1.542	0.624	0.595	0.654	1.220	1.127	1.322
	C17	2.083	1.972	2.200	1.731	1.657	1.808	1.502	1.423	1.584
Rn20235	C5	2.171	2.042	2.307	1.529	1.432	1.633	0.846	0.807	0.886
	C39	0.869	0.838	0.900	0.938	0.892	0.986	0.515	0.503	0.527
Rb20236	C21	2.351	1.979	2.793	1.093	0.925	1.292	1.361	1.155	1.603
	C24	3.987	3.628	4.382	1.548	1.426	1.682	2.033	1.853	2.230
Rb20237	C2	1.577	1.318	1.886	0.818	0.745	0.899	0.379	0.364	0.394
	C5	1.427	1.373	1.483	0.845	0.793	0.900	0.529	0.507	0.552

In order to ensure the presence or absence of the *SCN5A*_c.4573G>A SNV in the selected clones, we sequenced exon 27 of *SCN5A* in genomic DNA samples. We confirmed the presence of *SCN5A*_c.4573G>A in Rb20234, Rb20235 and Rb20236 iPSc selected clones, and its absence in Rb20237 iPSc selected clones (**Figure 45**).

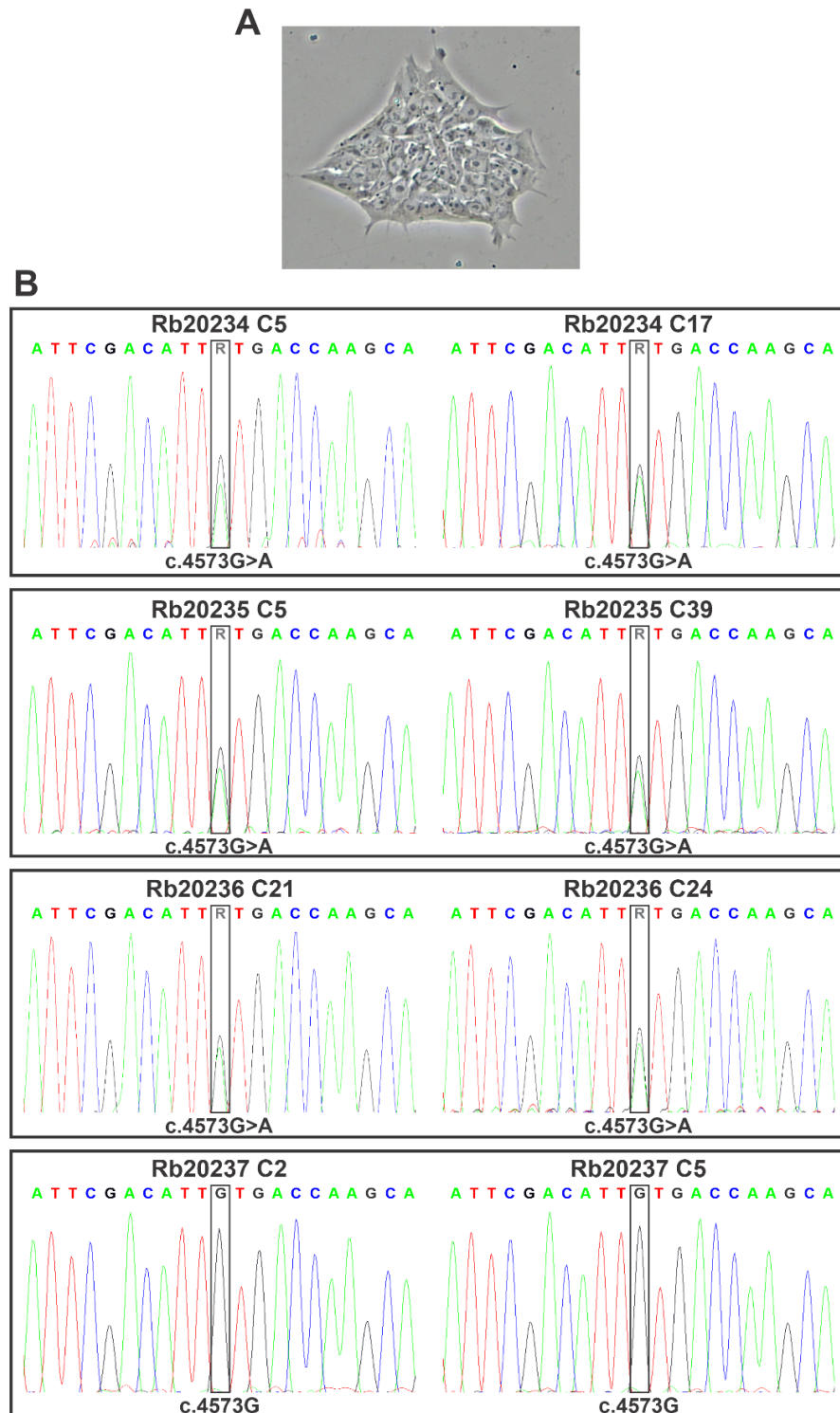

Figure 45. Sequencing of the *SCN5A* region harboring the SNV in iPSc selected clones. (A) Representative bright field microscopy image of iPSc colonies in culture. **(B)** The SNV

SCN5A_c.4573G>A was identified in genomic DNA isolated from iPSc clones in individuals Rb20234 (first row), Rb20235 (second row) and Rb20236 (third row), but not in individual Rb20237 (fourth row).

2.2. Clone characterization

To assure that our iPSc were suitable for differentiation, we sent one of the two selected iPSc clones of each patient for a thorough characterization in Centre De Medicina Regenerativa de Barcelona (CMRB). The results from this characterization are summarized in **Table 34**.

Table 34. Summary of the results of the iPSc characterization.

	Rb20234 C17	Rb20235 C5	Rb20236 C21	Rb20237 C5
Mycoplasma analysis	Negative	Negative	Negative	Negative
Reprogramming plasmids presence	Negative	Negative	Negative	Negative
Alkaline phosphatase	Positive	Positive	Positive	Positive
Karyotype	46, XX	46, XY	46, XX	46, XY
Pluripotency test	Positive for Oct-4, SSEA-3, SSEA-4, Nanog, Sox-2, TRA-1-60, TRA-1-81	Positive for Oct-4, SSEA-3, SSEA-4, Nanog, Sox-2, TRA-1-60, TRA-1-81	Positive for Oct-4, SSEA-3, SSEA-4, Nanog, Sox-2, TRA-1-60, TRA-1-81	Positive for Oct-4, SSEA-3, SSEA-4, Nanog, Sox-2, TRA-1-60, TRA-1-81
In vitro differentiation	Ectoderm positive: Tuj1, GFAP	Ectoderm positive: Tuj1	Ectoderm positive: Tuj1	Ectoderm positive: Tuj1
	Endoderm positive: AFP, FOXA2	Endoderm positive: AFP, FOXA2	Endoderm positive: AFP, FOXA2	Endoderm positive: AFP, FOXA2
	Mesoderm positive: ASMA, ASA	Mesoderm positive: ASMA	Mesoderm positive: ASMA	Mesoderm positive: ASMA

Table 34 shows the absence of mycoplasma contamination and reprogramming plasmids in the four iPSc clones studied. The selected iPSc clones stained positive for alkaline phosphatase activity (**Table 34**). This enzyme's activity is up-regulated in pluripotent stem cells, thus it is a method widely used to identify iPSc. Moreover, the iPSc clones displayed a normal karyotype (**Table 34**). **Figure 46** shows the alkaline phosphatase staining and karyotype from a representative iPSc clone, and **Annex Figure 6** depicts the other three clones.

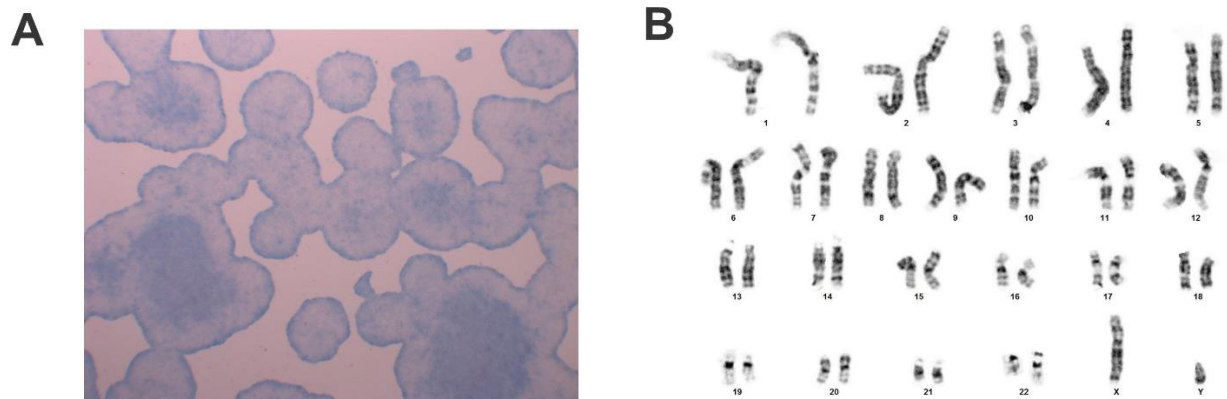

Figure 46. Alkaline phosphatase staining (A) and karyotype (B) of Rb20235 C5 iPSc.

In agreement with our qPCR results presented in **section 2.1**, the iPSc clones tested positive in immunohistochemical studies for several pluripotency transcription factors (**Figure 47**).

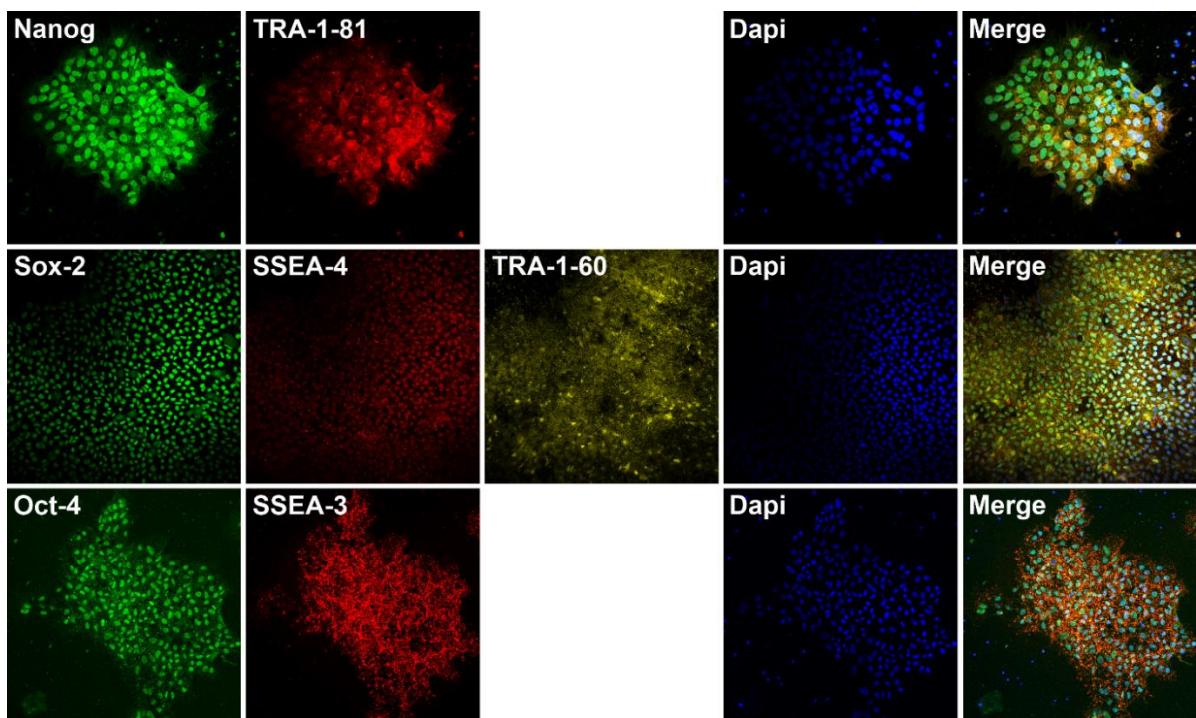

Figure 47. Pluripotency characterization of Rb20234 C17 iPSc clone. iPSc clone Rb20234 C17 tested positive for pluripotency markers Nanog and TRA-1-81 (upper panel), Sox-2, SSEA-4 and TRA-1-60 (middle panel), and Oct-4 and SSEA-3 (bottom panel).

Furthermore, immunohistochemical staining for characteristic markers of cells derived from the three germ layers after in vitro differentiation confirmed the ability of the selected clones to differentiate into cells of the three germ layers (**Figure 48**).

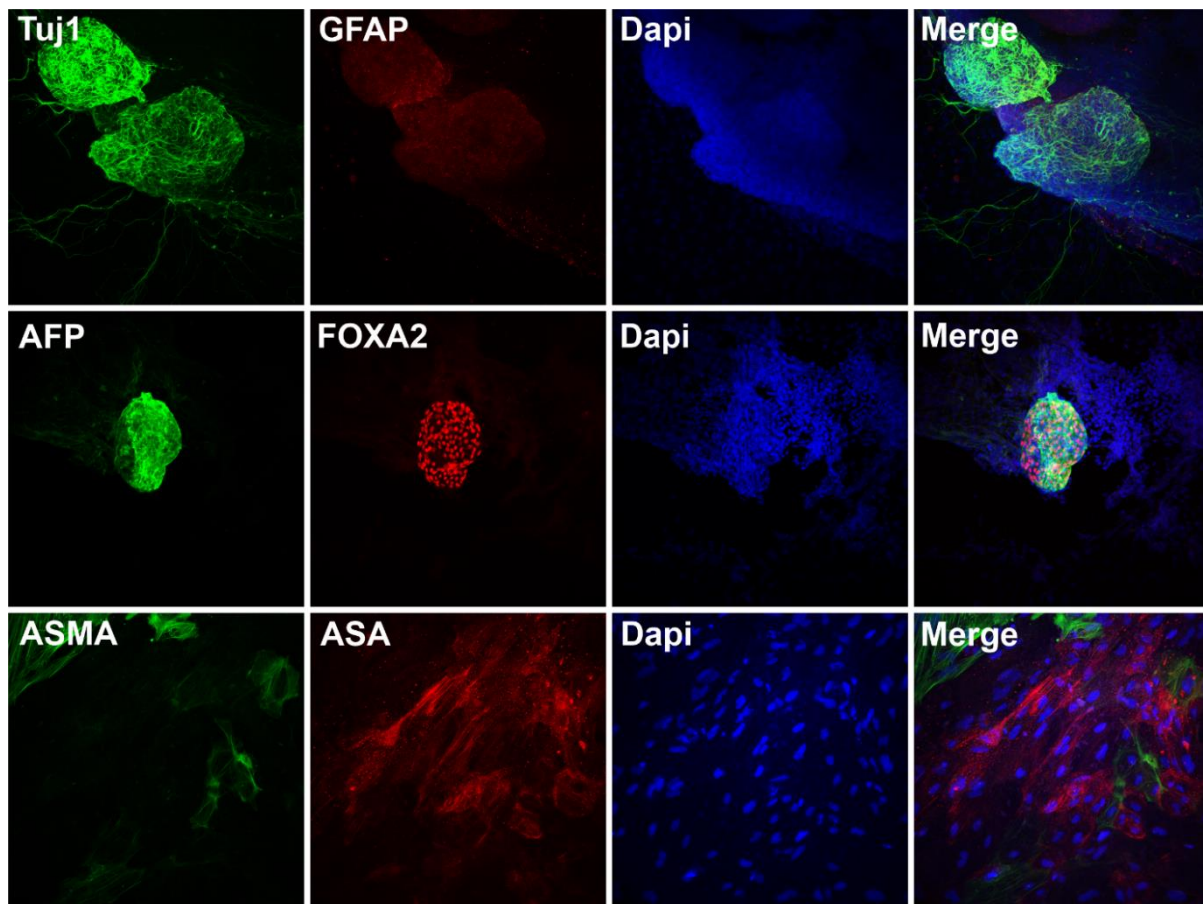

Figure 48. In vitro differentiation of Rb20234 C17 iPSc clone into the three germ layers. Studies of in vitro differentiation to cells of the three germ layers showed the capacity of the studied iPSc to differentiate into cells of the ectoderm (positive staining for Tuj1 and GFAP, upper panel), endoderm (positive staining for AFP and FOXA2, middle panel), and mesoderm (positive staining for ASMA and ASA, bottom panel).

The complete immunohistochemical studies of the other iPSc clones can be found in **Annex Figures 7-9.**

3. iPS cell differentiation to cardiomyocytes

Characterization of the newly generated iPS cell lines indicated that they displayed the expected features for iPSc. Therefore, we proceeded with the differentiation of these iPSc into cardiomyocytes. This would allow us to characterize the effect of the SNV on the electrophysiological properties of the cardiac sodium current, in a cardiomyocyte-like environment holding the patient-specific genetic background.

3.1. Optimization of the differentiation protocol

We used the non-related control GPG1 iPSc to optimize a differentiation protocol which would render a high yield of pure mature cardiomyocytes. To do so, we tried different published differentiation protocols. First we followed Xu *et al.*²¹⁴ protocol, based in the formation of embryoid bodies. Although we obtained beating iPS-CM, the yield was low, so we switched to a monolayer-based differentiation protocol, published by Zanella *et al.*²¹⁵

Since the results with these protocols were below optimal, we implemented a different protocol published by Lin *et al.*²¹⁰ A full description of the protocol is explained in **Methods section 3.4.2**. However, to improve the yield of healthy beating iPS-CM, we introduced some modifications. First, we added ROCK inhibitor (ROCKi) from day 2 to 5 to increase cell survival. This improvement yielded a monolayer of beating cells. To obtain a purer and more homogeneous iPS-CM culture, we used glucose starvation as reported by Sharma *et al.*¹³⁶ This protocol is based on the capacity of cardiomyocytes to metabolize lactate, while other, non-differentiated cells cannot survive in the absence of glucose. Thus, we fed the cells with a medium without glucose (**Methods Table 6**) on differentiation days 10, 12 and 14.

Ongoing work in the lab by David Carreras is focused on maturing iPS-CM, as it is known that these differentiated cells display a structural and electrical immature phenotype. He validated that replating the cells to a new matrigel-coated well on differentiation day 16, and adding T3 and Dex from day 16 to day 30 as reported by Parikh *et al.*²¹¹ increased cardiomyocyte maturity. Therefore, we introduced these improvements to our protocol.

On differentiation day 30, cells were either collected for the cardiomyocyte characterization or disaggregated for the electrophysiological studies. All the experiments shown in this thesis were performed using the iPS-CM obtained with the complete protocol, which included all the improvements (**Figure 49**).

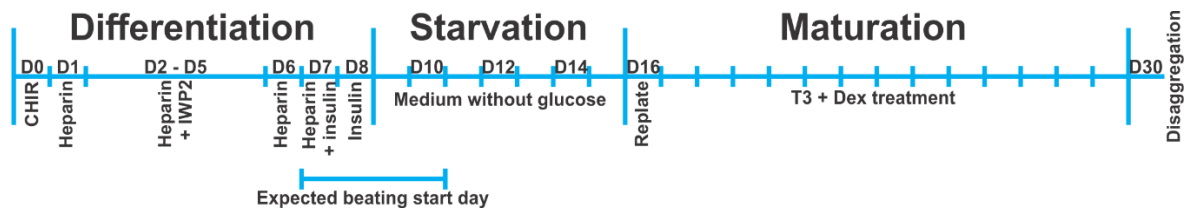

Figure 49. Schematic representation of the optimized differentiation protocol. Protocol based on the studies published by Lin et al, Sharma et al, and Parikh et al, and including our modifications.

3.2. Cardiomyocyte characterization

To assess whether the optimized differentiation protocol yielded a good population of iPS-CM, we measured the absence and presence of pluripotency and cardiomyocyte markers, respectively. For this purpose, we performed qPCRs on three differentiation rounds of each selected clone on day 30 of differentiation. We first compared the expression levels of pluripotency transcription factors in iPS-CM samples with their respective iPS cell clones.

Figure 50 and Annex Tables 9-12 show that the expression levels of the pluripotency transcription factors studied were severely decreased in iPS-CM compared to the iPS cell clones. Thus, iPS-CM did not express pluripotency markers, as expected.

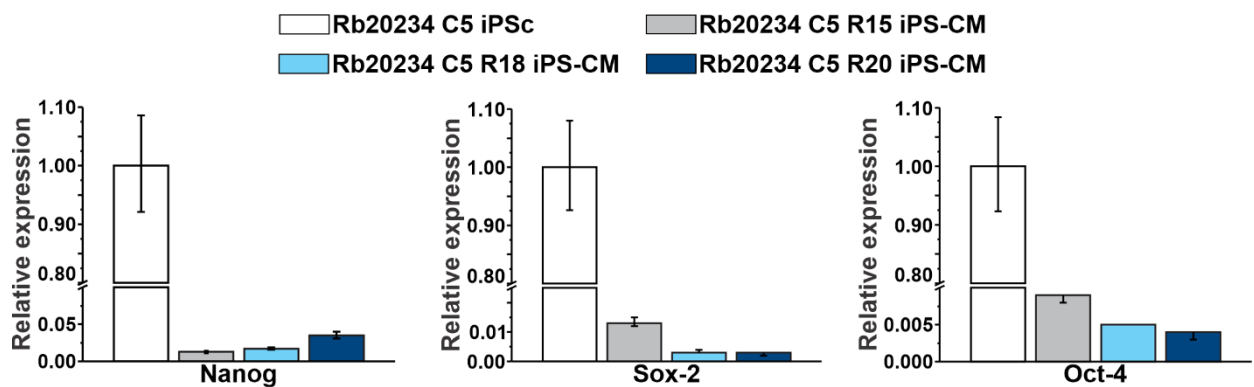

Figure 50. iPS-CM do not express pluripotency transcription factors compared to the iPSc. The relative expression of pluripotency transcription factors Nanog (left), Sox-2 (middle) and Oct-4 (right) is shown as mean values of biological triplicates \pm minimum and maximum relative quantification for 3 rounds of differentiation of one representative clone.

To confirm that the obtained cells showed characteristics of cardiomyocyte type cells, we assessed the expression of three cardiac gene markers (*MYBPC3*, *TNNI3* and *SCN5A*) in iPS-CM in comparison to the iPS cell clones.

All three cardiac genes were overexpressed in the iPS-CM compared to iPS cell clones (**Figure 51 and Annex Tables 13-16**), being *MYBPC3* the most expressed gene.

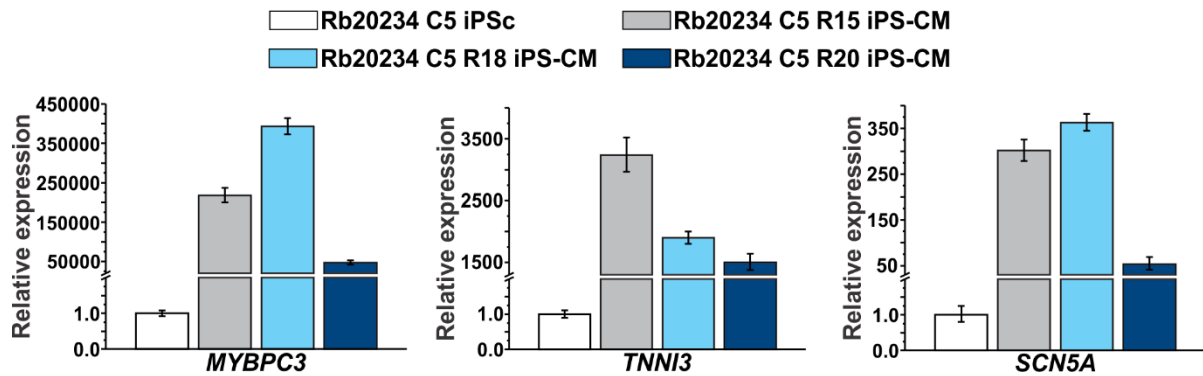

Figure 51. iPS-CM overexpress cardiac gene markers compared to the iPSc. The relative expression of cardiac gene markers MYBPC3 (left), TNNI3 (middle) and SCN5A (right) is shown as mean values of biological triplicates \pm minimum and maximum relative quantification for 3 rounds of differentiation of one representative clone.

4. Electrophysiological characterization of iPS-CM

Once we confirmed that the iPS-CM obtained for each clone of the four family members showed characteristics of cardiomyocyte-type cells, we aimed to study the sodium current properties on this cellular model. Between 6 and 12 differentiation rounds for each individual were studied.

4.1. Evaluation of individual Rb20237 as a suitable control

First, we evaluated whether the non-carrier member of the family (Rb20237) was a suitable control for the electrophysiological experiments. To assess this, we studied and compared the sodium current properties of iPS-CM from the related control Rb20237 with the non-related control GPG1 using the whole cell patch clamp technique.

Our electrophysiological studies evidenced that iPS-CM from both Rb20237 iPSc clones displayed similar sodium current properties (**Table 35**). Thus, we pooled the results from the two clones for all the experiments analyses.

Both Rb20237 and GPG1 iPS-CM displayed similar peak I_{Na} density (**Figure 52B** and **Table 35**), and no differences were observed in the voltage dependence of activation (**Figure 52C** and **Table 35**). However, voltage dependence of steady-state inactivation of GPG1 showed a positive shift of 4 mV compared to Rb20237 (**Figure 52C** and **Table 35**). Recovery from inactivation values were similar (**Figure 52D** and **Table 35**).

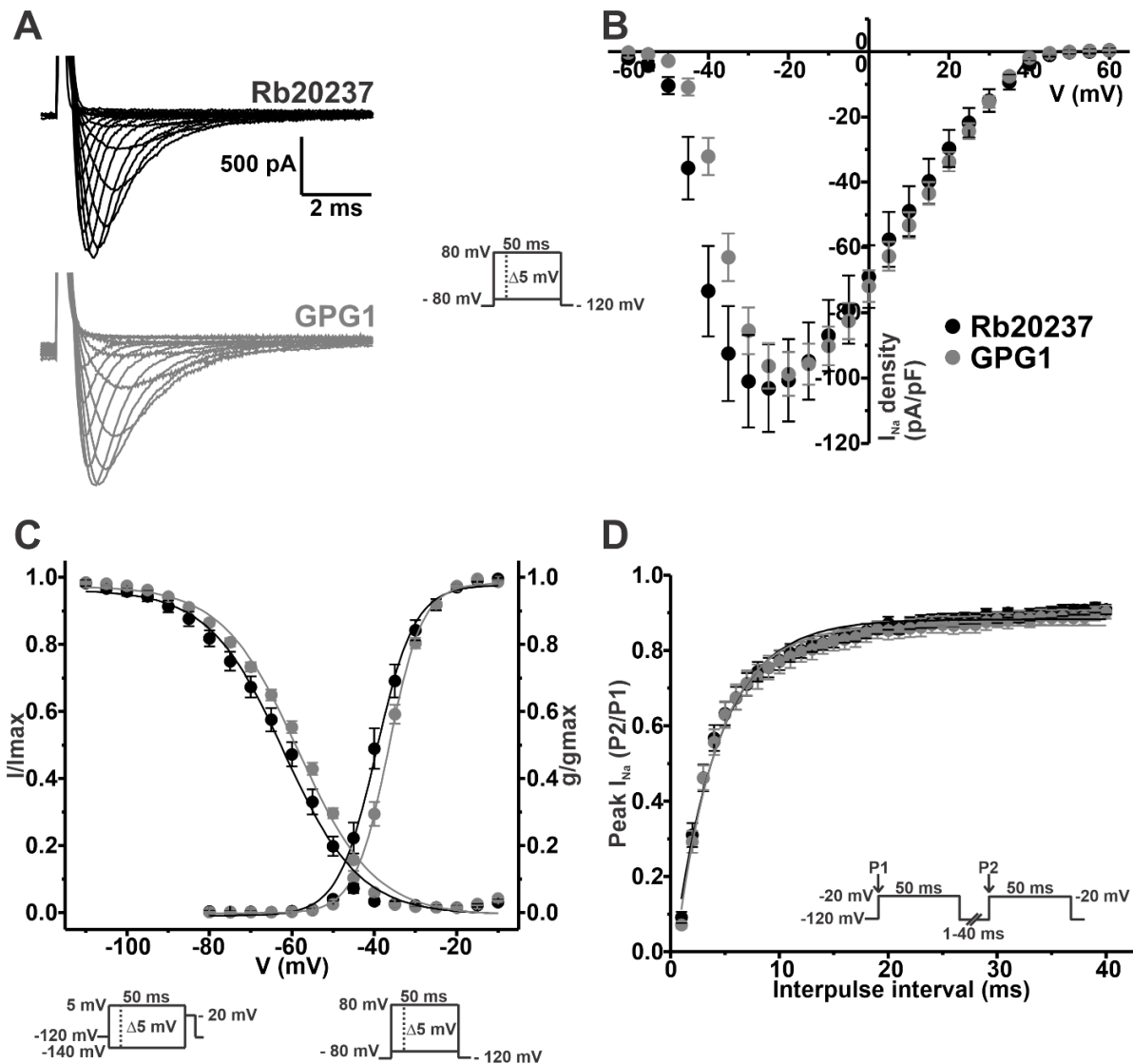

Figure 52. The family-related and non-related controls display similar sodium current properties.

Whole cell currents were elicited by depolarizing potentials as shown in the insets. Black circles depict data for Rb20237 iPS-CM, and grey circles represent GPG1 iPS-CM. Values are expressed as mean \pm SEM. **(A)** Representative whole cell Na^+ current traces from RB20237 (top) and GPG1 (bottom). **(B)** Mean peak current density-voltage relationship. I_{Na} amplitude was normalized by the cell capacitance to obtain I_{Na} density values. **(C)** I_{Na} steady-state voltage dependence of activation and inactivation plots. Data was fitted to a Boltzmann equation (solid lines). **(D)** Recovery from inactivation curves. Data was fitted to a monoexponential function (solid lines).

Table 35. Biophysical parameters of both Rb20237 clones, Pooled Rb20237 and GPG1 iPS-CM.

Parameter	Rb20237 C2	Rb20237 C5	Pooled Rb20237	GPG1
Peak I_{Na} density				
pA/pF	-94.69±17.36	-109.17±19.69	-103.10±13.41	-98.74±6.70
n	13	18	31	28
Activation				
$V_{1/2}$ (mV)	-37.28±1.51	-39.94±1.38	-38.77±1.04	-36.60±0.57
k	3.63±0.37	3.46±0.42	3.54±0.28	3.65±0.14
n	13	18	31	28
Steady-state inactivation				
$V_{1/2}$ (mV)	-61.07±1.48	-62.54±2.23	-62.43±1.40	-58.54±0.76*
k	8.51±0.48	7.42±0.55	8.10±0.37	8.99±0.18*
n	12	12	24	25
Recovery from inactivation				
τ (ms)	3.66±0.51	4.62±0.64	4.17±0.42	4.30±0.53
n	8	9	17	19

Data is presented as Mean \pm SEM. I_{Na} = sodium current; n = number of cells; $V_{1/2}$ = voltage for half-maximal activation or steady-state inactivation; k = slope factor; τ = time constant. Differences between data were analyzed with a t-test. *vs Pooled Rb20237. Significantly different, p-value < 0.05.

4.2. Sodium current density is decreased in Rb20234 and Rb20235 individuals

After confirming that Rb20237 was suitable as a related-control, we aimed to determine whether the SNV *SCN5A_c.4573G>A* affected the cardiac $Nav1.5$ sodium current density in the carrier individuals Rb20234, Rb20235 and Rb20236. Similar to Rb20237, both selected clones of Rb20234, Rb20235 and Rb20236 displayed similar sodium current properties and thus data was pooled for all the electrophysiological experiments (**Annex Tables 18-20**).

To avoid clamp artifacts or recordings saturation, especially in control iPS-CMs where the currents were expected to be large, cells were bathed in low sodium solution to decrease I_{Na} . Surprisingly, we observed that a high percentage of iPS-CM from individuals Rb20234 and Rb20235 did not display recordable I_{Na} (**Figure 53**). While more than 60% of iPS-CM from Rb20234 and Rb20235 failed to show recordable I_{Na} , this was not reproduced in individuals Rb20237 and Rb20236, as the percentage was of 10% and 5% respectively.

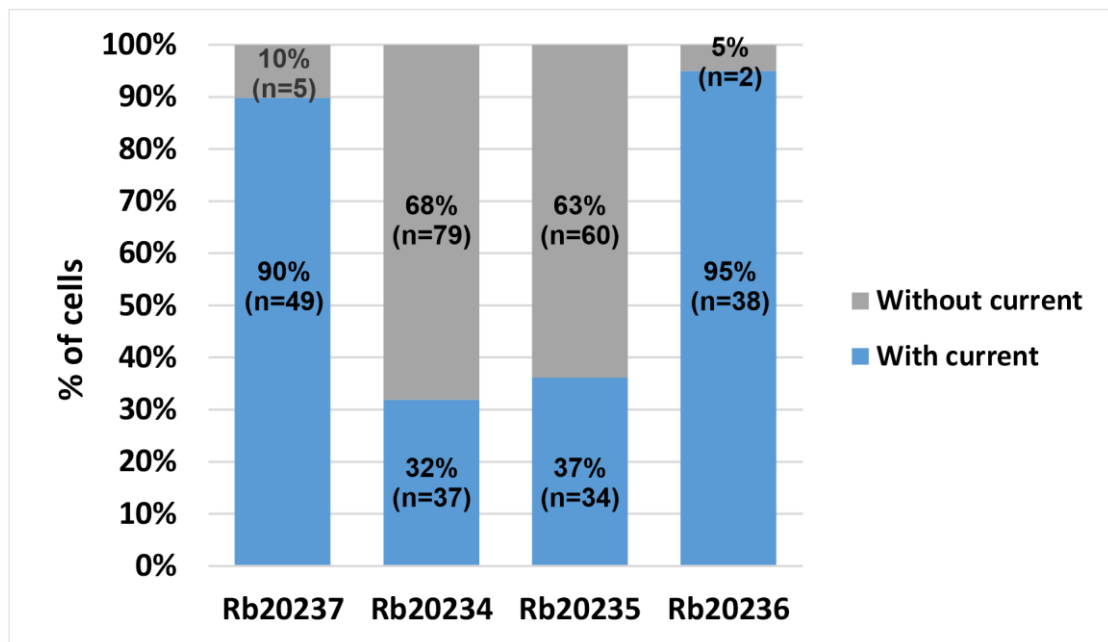

Figure 53. More than 60% of Rb20234 and Rb20235 iPS-CM did not show recordable I_{Na} . Grey portion of the bar graph represents percentage and number of cells without recordable I_{Na} . Blue portion represents percentage and number of cells with recordable I_{Na} .

We investigated if the lack of recordable I_{Na} in Rb20234 and Rb20235 iPS-CM was due to the presence of different cardiomyocyte types among the cells studied. It is known that nodal cells do not display $Na_v1.5$ sodium current. A heterogeneous population of cardiomyocytes, potentially enriched in nodal cells, could have been obtained during iPS-CM differentiation, and could explain the absence of recordable I_{Na} in these 2 patients. To rule out this hypothesis, we assessed the expression of ventricular, atrial and nodal markers (*MYL2*, *MYL7* and *HCN4* genes, respectively) in 5 rounds of each individual by qPCR. *MYL2* and *MYL7* relative quantification values for each differentiation round were normalized by those of *HCN4*. We measured the expression of the markers in the Rb20234, Rb20235 and Rb20236 iPS-CM, relative to the control Rb20237.

As shown in **Figure 54**, the studied ventricular and atrial markers are similarly overexpressed in the three individuals in comparison to the control Rb20237. Thus, the lack of recordable I_{Na} in iPS-CM from individuals Rb20234 and Rb20235 cannot be attributed to a diminished expression of ventricular or atrial-type cells in any of the patient-specific iPS-CM. The complete Rq values can be found in **Annex Table 17**.

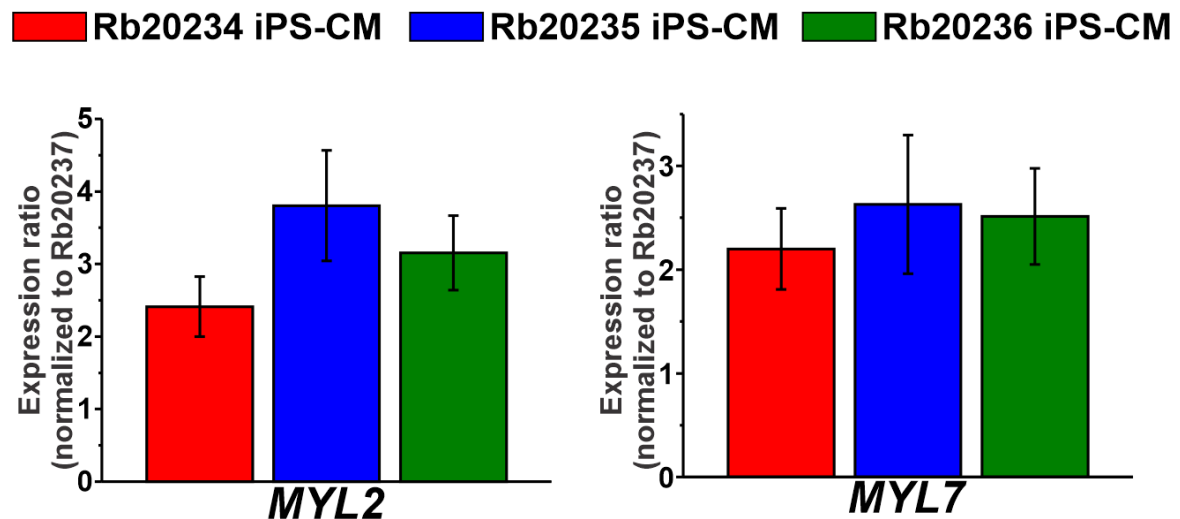

Figure 54. Rb20234, Rb20235 and Rb20236 iPS-CM overexpress ventricular and atrial markers compared to the nodal marker. The ratio between the ventricular marker *MYL2* or the atrial marker *MYL7* and the nodal marker *HCN4* for individuals Rb20234, Rb20235 and Rb20236 was normalized by the ratios obtained for individual Rb20237 to obtain the relative expression. The relative expression of *MYL2* (left) and *MYL7* (right) is shown as mean values of biological triplicates \pm SEM for 5 rounds of differentiation. Differences between data were analyzed with a one-way ANOVA with a post-hoc Tukey test.

The analysis of the sodium current properties for individuals Rb20234 and Rb20235 was performed using the cells that did show recordable I_{Na} . Analysis of the data revealed a reduction of I_{Na} density in Rb20234 and Rb20235 iPS-CM of 77.7% and 78.1%, respectively compared to Rb20237 (**Figure 55B** and **Table 36**). On the contrary, I_{Na} density of Rb20236 was increased by 68.3% compared to Rb20237 (**Figure 55B** and **Table 36**).

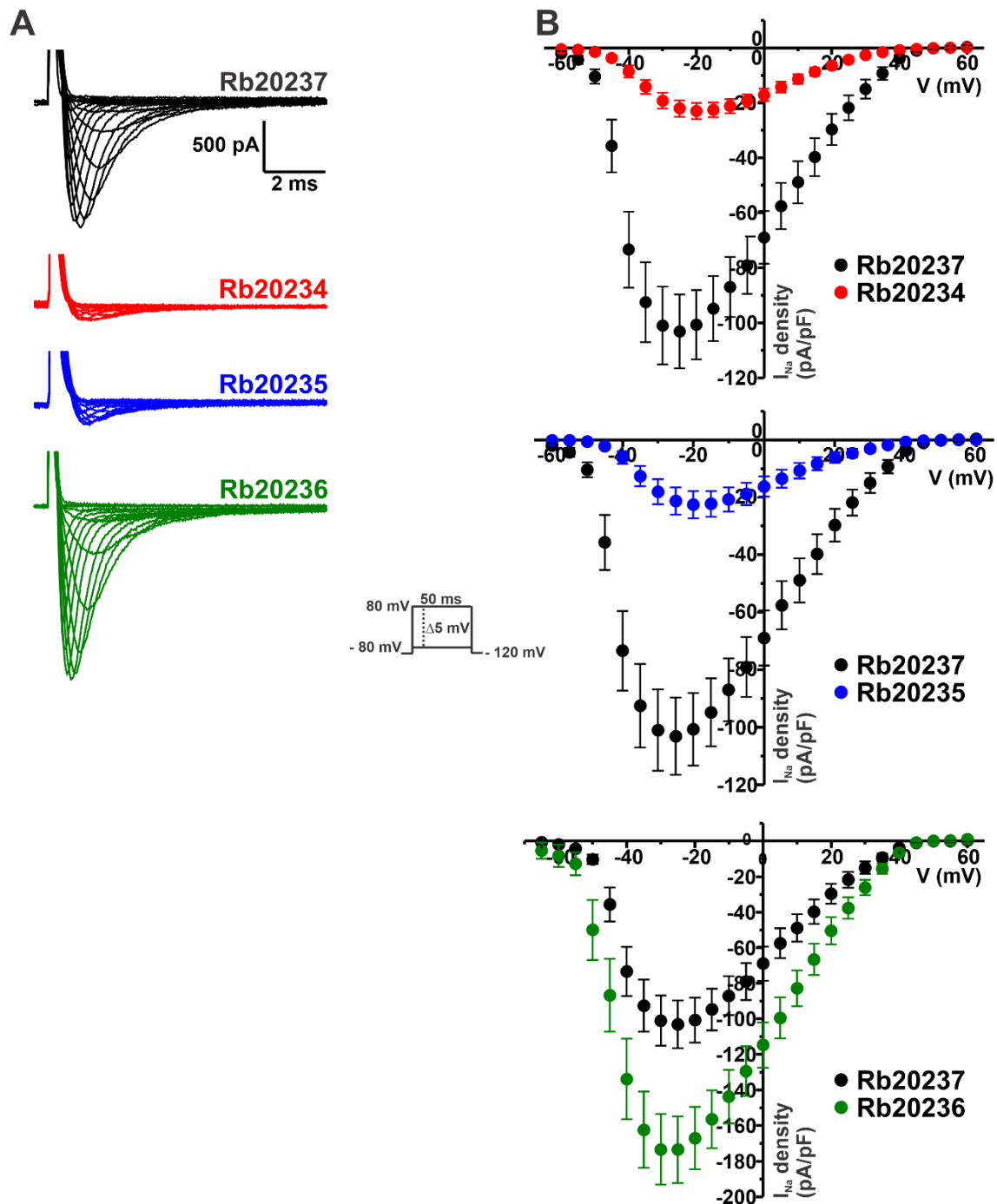

Figure 55. SNV *SCN5A_c.4573G>A* drastically decreases I_{Na} density in Rb20234 and Rb20235, and increases I_{Na} density in Rb20236. Whole cell currents were elicited by depolarizing potentials as shown in the insets. Black circles depict data for Rb20237, red circles represent Rb20234, blue circles represent Rb20235, and green circles represent Rb20236 iPS-CM. Values are expressed as mean \pm SEM. **(A)** Representative whole cell Na^+ current traces from Rb20237 (top left), Rb20234 (top right), Rb20235 (bottom left) and Rb20236 (bottom right). **(B)** Mean peak current density-voltage relationship compared to Rb20237 of Rb20234 (top left), Rb20235 (top right) and Rb20236 (bottom). Peak I_{Na} amplitude was normalized by the cell capacitance to obtain peak I_{Na} density values.

Table 36. Sodium current density parameters of the four individuals of the family.

Parameter	Rb20237	Rb20234	Rb20235	Rb20236
Peak I_{Na} density				
pA/pF	-103.10±13.41	-22.96±2.90*	-22.53±4.72*	-173.55±18.73*
n	31	21	20	24

Data is presented as Mean \pm SEM. I_{Na} = sodium current; n = number of cells. Differences between data were analyzed with a t-test. *vs Rb20237. Significantly different, p-value < 0.05.

We measured the inactivation time constant at different voltages using the same I-V pulse protocol. We fitted the data to a double-exponential function. However, since the current of Rb20234 and Rb20235 iPS-CM was so small, the fit of the slow component was not accurate. Thus, we are representing only the time constant for the fast component (τ fast). As shown in **Figure 56**, τ fast was significantly increased in Rb20234 and Rb20235 iPS-CM at more negative potentials (identified with the symbol *), compared to Rb20237. In addition, τ fast was also significantly increased in Rb20235 iPS-CM at more positive potentials, with respect to Rb20237.

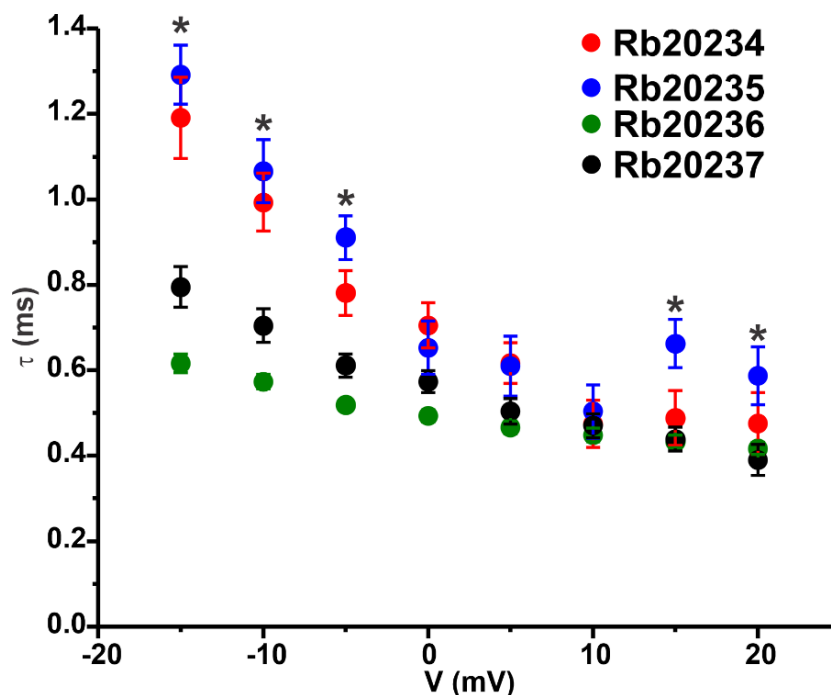

Figure 56. SNV *SCN5A*_c.4573G>A increases τ fast in Rb20234 and Rb20235. Black circles depict data for Rb20237, red circles represent Rb20234, blue circles represent Rb20235, and green circles represent Rb20236 iPS-CM. Values are expressed as mean \pm SEM. Differences between data were analyzed with a t-test. *vs Rb20237. Significantly different, p-value < 0.05.

4.3. Voltage dependence of activation and steady-state inactivation are positively shifted in Rb20234 and Rb20235 iPS-CM

We next assessed whether the SNV *SCN5A_c.4573G>A* modified the voltage dependence of activation and steady-state inactivation sodium current properties. Since the steady-state inactivation values between the control Rb20237 and the non-related control GPG1 were significantly different, we compared the values obtained for the iPS-CM corresponding to the carriers with both the related and non-related controls.

As shown in **Figure 57** and **Table 37**, we observed a positive shift of the voltage dependence of the activation curve for Rb20234 and Rb20235 respect to Rb20237 ($V_{1/2}$ increased 5 mV and 8 mV, respectively) and also respect to GPG1 ($V_{1/2}$ increased 2.5 mV and 6 mV, respectively). Fitting of the steady-state voltage dependence of inactivation data to a Boltzmann equation also evidenced a positive shift of the curve in the SNV carriers Rb20234 and Rb20235 compared to Rb20237 ($V_{1/2}$ increased 8 mV and 7 mV, for Rb20234 and Rb20235 respectively; **Figure 57** and **Table 37**) and to GPG1 ($V_{1/2}$ increased 4 mV and 3 mV, for Rb20234 and Rb20235 respectively; **Table 37**).

Neither of these shifts was observed in the iPS-CM from SNV carrier Rb20236, compared to both Rb20237 (**Figure 57** and **Table 37**) or GPG1 (**Table 37**).

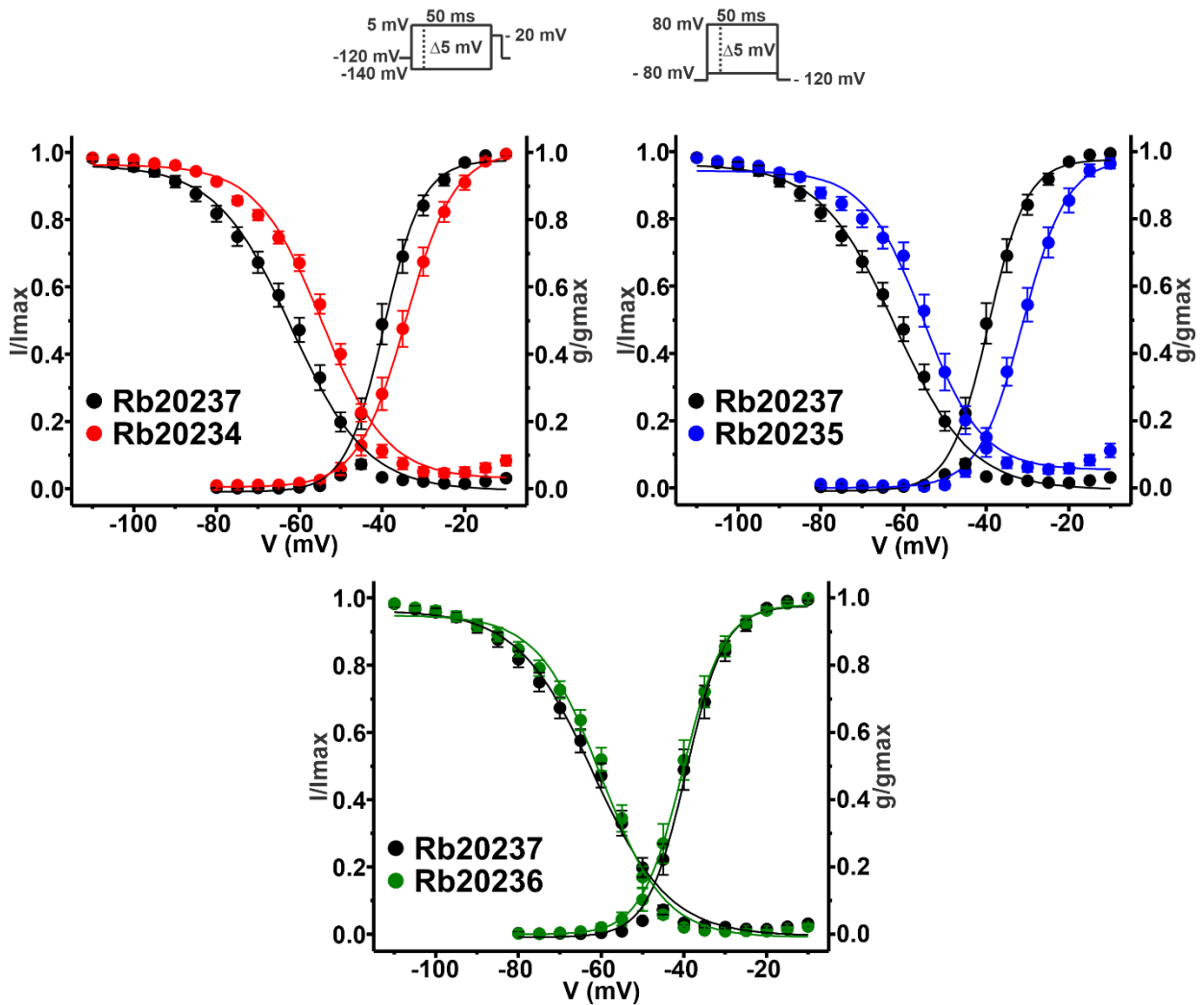

Figure 57. SNV *SCN5A*_c.4573G>A shifts voltage dependence of activation and steady-state inactivation in Rb20234 and Rb20235. I_{Na} steady-state voltage dependence of activation and inactivation plots for Rb20234 (top left), Rb20235 (top right) and Rb20236 (bottom), compared to Rb20237. Whole cell currents were elicited by depolarizing potentials as shown in the insets. Black circles depict data for Rb20237, red circles represent Rb20234, blue circles represent Rb20235, and green circles represent Rb20236 iPS-CM. Solid lines represent the fitted Boltzmann curves. Values are expressed as mean \pm SEM.

Table 37. Sodium current voltage dependence of activation and steady-state inactivation parameters of the four individuals of the family.

Parameter	Rb20237	Rb20234	Rb20235	Rb20236	GPG1
Activation					
$V_{1/2}$ (mV)	-38.77±1.04	-34.09±1.23* ^ψ	-30.33±1.23* ^ψ	-40.10±1.22	-36.60±0.57
k	3.54±0.28	4.81±0.25* ^ψ	4.92±0.34* ^ψ	4.04±0.39	3.64±0.14
n	31	22	19	20	29
Steady-state inactivation					
$V_{1/2}$ (mV)	-62.43±1.40	-54.66±0.99* ^ψ	-55.14±1.46* ^ψ	-60.34±1.16	-58.54±0.76*
k	8.10±0.37	7.46±0.29* ^ψ	6.25±0.65* ^ψ	7.18±0.50	8.99±0.18
n	24	18	15	18	25

Data is presented as Mean ± SEM. $V_{1/2}$ = voltage for half-maximal activation or steady-state inactivation; k = slope factor; n = number of cells. Differences between data were analyzed with a t-test. *vs Rb20237. ^ψvs GPG1. Significantly different, p-value < 0.05.

4.4. Recovery from Inactivation is only affected in Rb20234 iPS-CM

We then assessed the Recovery from Inactivation, illustrated in **Figure 58** and summarized in **Table 38**.

Data fitted to a monoexponential function showed a significant increase in the time constant of Rb20234 iPS-CM, compared to Rb20237. Interestingly, we did not detect this increase in the iPS-CM of the remaining SNV carriers Rb20235 and Rb20236.

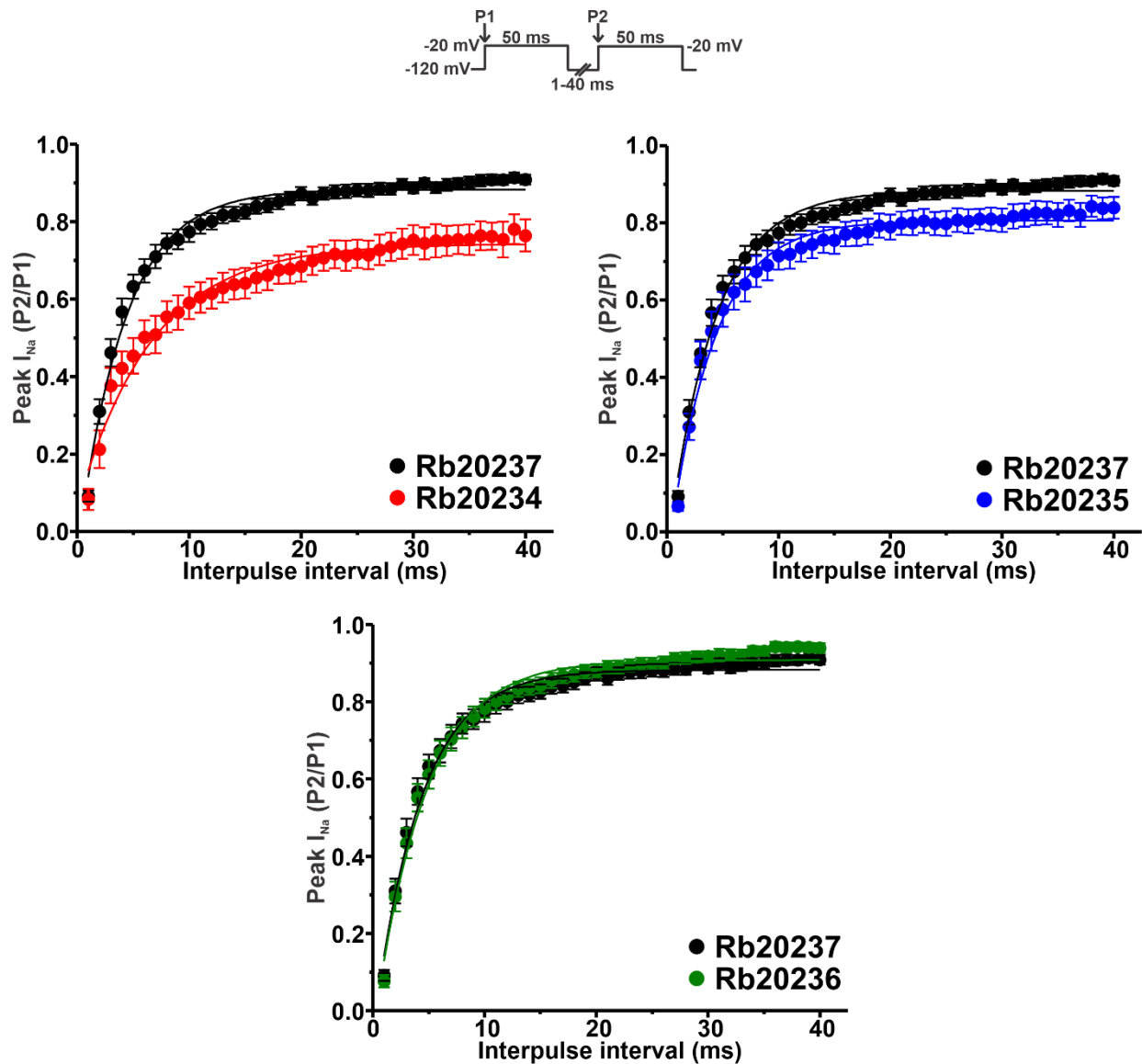

Figure 58. Recovery from inactivation time constant is only increased in Rb20234 iPS-CM. Recovery from Inactivation plots comparing Rb20237 with Rb20234 (top left), Rb20235 (top right) or Rb20236 (bottom). Whole cell currents were elicited by depolarizing potentials as shown in the insets. Black circles depict data for Rb20237, red circles represent Rb20234, blue circles represent Rb20235, and green circles represent Rb20236 iPS-CM. Solid lines in panels represent the fitted monoexponential curves. Values are expressed as mean \pm SEM.

Table 38. Recovery from inactivation time constant of the four individuals of the family.

Parameter	Rb20237	Rb20234	Rb20235	Rb20236
Recovery from inactivation				
τ (ms)	4.17 \pm 0.42	6.68 \pm 0.88*	4.79 \pm 0.67	4.37 \pm 0.47
n	17	13	15	17

Data is presented as Mean \pm SEM. τ = time constant; n = number of cells. Differences between data were analyzed with a t-test. *vs Rb20237. Significantly different, p-value < 0.05.

4.5. The relative expression of *SCN5A* is not decreased in Rb20234 and Rb20235

iPS-CM

We observed a dramatic loss of function of the Nav1.5 channel in the electrophysiological studies in Rb20234 and Rb20235 iPS-CM. Thus, we aimed to assess by qPCR whether the reduction in I_{Na} density in these individuals could be caused by a decrease in *SCN5A* expression.

As shown in **Figure 59**, *SCN5A* relative expression compared to Rb20237 is not decreased in iPS-CM from Rb20234, Rb20235 and Rb20236. Thus, the decrease in I_{Na} density observed in Rb20234 and Rb20235 iPS-CM is not caused by a reduction in *SCN5A* expression. The Rq values of each of the 5 rounds of differentiation studied for each patient can be found in **Annex Table 21**.

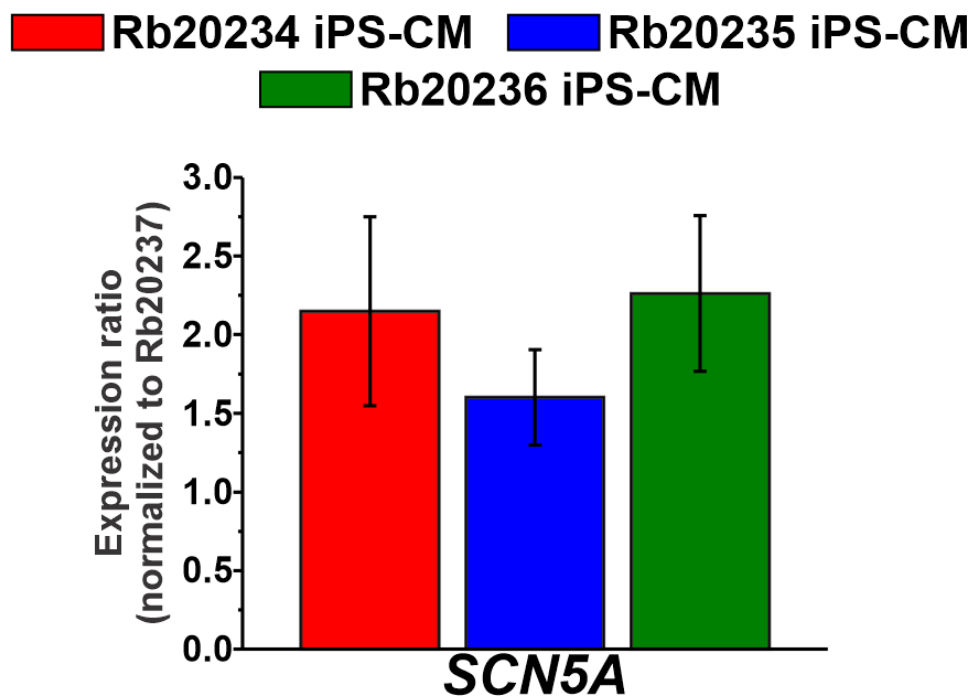

Figure 59. *SCN5A* expression in Rb20234, Rb20235 and Rb20236 iPS-CM is not decreased, compared to Rb20237. The relative expression of *SCN5A* is shown as mean values of biological triplicates \pm SEM for 5 rounds of differentiation. Differences between data were analyzed with a one-way ANOVA with a post-hoc Tukey test.

5. Study of the genetic background with a panel of genes related to cardiac arrhythmias

The complete pedigree of the family (**Rationale of the research Figure 22**) showed incomplete penetrance of *SCN5A_c.4573G>A*. Given that a possible explanation of this feature is the individual-specific genetic background, we sequenced 85 genes associated to cardiac arrhythmogenic diseases using a customized panel (see **Methods section 4.2**) in search for additional genetic variants that could be related to the differences observed between the three SNV carriers in the electrophysiological experiments.

We identified 12 rare SNVs, which are found in less than 1% of the population according to ExAC database (**Table 39**). As expected, the SNV in this study *SCN5A_c.4573G>A* was also identified in the panel.

Table 39. Rare SNVs found in the four individuals of the study. Green filled cells indicate the individual as carrier of the SNV.

SNV	Rb20234	Rb20235	Rb20236	Rb20237
<i>CACNB2_c.711G>A</i>				
<i>FBN1_c.8176C>T</i>				
<i>FLNC_c.6175G>A</i>				
<i>KCNH2_c.2989A>G</i>				
<i>SCN5A_c.4573G>A</i>				
<i>SCN5A_c.1587T>C</i>				
<i>SCN5A_c.717C>T</i>				
<i>TTN_c.99478G>A</i>				
<i>TTN_c.81314G>A</i>				
<i>TTN_c.61114G>A</i>				
<i>TTN_c.95876T>C</i>				
<i>TTN_c.28892C>T</i>				

We also identified multiple common variants, found in more than 1% of the population. Among them, 40 were carried by the four members of the family (**Annex Tables 22-23**) and 59 were carried by some but not all the four members of the family (**Annex Tables 24-25**). From all these variants, what we found more revealing is that the mother Rb20236 is the only carrier of the SNV *SCN5A_c.1673A>G*. The resulting protein Nav1.5_p.H558R is a known modulator of the sodium current that restores abnormal channel properties caused by other *SCN5A* SNVs²¹⁶.

Other identified variants worth mentioning will be further explained in the discussion.

VI. Discussion

Study 1: *SCN1B* variant associated with concomitant brain and cardiac disorders

In the first study of this Thesis, we presented the effect of an *SCN1B* SNV (c.308A>T; leading to p.D103V), affecting both $\beta 1$ and $\beta 1b$ regulatory subunits, over the heart- and brain-type sodium currents. We showed evidence of the deleterious effect of the SNV on both heart and brain sodium currents. This strongly suggests that the variant affecting the $\beta 1$ and $\beta 1b$ subunits is underlying the concomitant brain and cardiac disorders observed in the proband. These data have been published in a scientific paper, in which I am the first author.²¹⁷

The following sections include a point-by-point discussion of our results in relation to our hypotheses.

1. The SNV *SCN1B_c.308A>T* alters the regulatory properties of the $\beta 1$ and $\beta 1b$ subunits over Nav1.5 and Nav1.1 channels

To assess the first hypothesis proposed for this study, we aimed to determine whether the mutant $\beta 1^{D103V}$ and $\beta 1b^{D103V}$ subunits affected Nav1.5 and Nav1.1 sodium current properties, compared to the wild type subunits. To have a direct control of our experiments with the mutated subunits, we first characterized the effect of the WT β subunits over the cardiac and neuronal sodium channel α subunit's properties.

The effect of the WT $\beta 1$ subunit over the biophysical properties of Nav1.5 and Nav1.1 sodium current has been widely characterized. As expected, our results are in agreement with previously published data.^{28,186,218–223} Summarizing, $\beta 1^{WT}$ expressed in HEK-293T cells caused an increase in I_{Na} , shifted the voltage dependence of activation towards hyperpolarizing potentials and reduced the recovery from inactivation time constant of Nav1.5. When $\beta 1^{WT}$ was co-expressed with Nav1.1, it increased I_{Na} density and accelerated the recovery from inactivation.

The effect of the WT $\beta 1b$ subunit on Nav1.5 current has not been studied extensively. Some groups have reported the presence of the $\beta 1b$ subunit in human and rat adult hearts.^{61,220} However, there are some controversies in the literature. Yuan *et al.* showed that the

expression levels of $\beta 1b$ in the atria and ventricle are greater than those of $\beta 1$.²²⁰ On the contrary, Watanabe *et al.* detected a relative low expression level of *SCN1Bb* compared with *SCN1B* in human ventricle.¹⁸⁶ In this study, we observed an increase in Nav1.5 current density in the presence of $\beta 1b^{WT}$ larger than that detected when $\beta 1^{WT}$ was co-transfected with the α subunit. Co-expression of the α subunit with $\beta 1b^{WT}$ also caused a decrease in the recovery from inactivation time constant, which has not been previously reported for the Nav1.5 channel.

Data on the modulatory effect of the $\beta 1b$ subunit on Nav1.1 is scarce and controversial. Some groups propose that $\beta 1b$ expression predominates in embryonic development and early life and is thus essential for brain development.^{61–63} Patino *et al.*⁶³ studied an epilepsy-related SNV that only affects the $\beta 1b$ subunit. Although their co-immunoprecipitation studies did not detect an association between $\beta 1b$ and Nav1.1 or Nav1.3 channels, they showed that $\beta 1b$ modulates the Nav1.3 sodium current in heterologous systems. Our study shows that the $\beta 1b^{WT}$ subunit modulates voltage dependence of inactivation by shifting the curve to more negative potentials. These data increase our current knowledge about the effects of $\beta 1b$ subunit on Nav1.1 channel.

1.1. $\beta 1^{D103V}$ but not $\beta 1b^{D103V}$ produces a loss of function of the cardiac sodium current

Mutations in the $\beta 1$ subunit have been implicated in various cardiac arrhythmias, such as BrS, AD, SIDS, LQT syndrome, and cardiac conduction defect.^{62,186,224–226} Here we show that the $\beta 1^{D103V}$ subunit caused a reduction in I_{Na} with respect to $\beta 1^{WT}$. In addition, the mutant subunit shifted the voltage dependence of activation towards more positive potentials, suggesting a physical interaction between $\beta 1^{D103V}$ and the alpha subunit. This interaction, however, appears not to disrupt Nav1.5 trafficking to the plasma membrane. This is supported by our data showing that relative plasma membrane levels of Nav1.5 were similar in the presence of either $\beta 1^{WT}$ or $\beta 1^{D103V}$. Thus, the mutant $\beta 1$ is likely to exert its effect over Nav1.5 directly on the channel electrical properties. Taking into account that the $\beta 1$ subunit is normally present in cardiac cells, this difference between $\beta 1^{WT}$ and $\beta 1^{D103V}$ would be considered a loss of function of the channel, which would be consistent with the progressive atrial standstill and cardiac conduction disorder observed in the patient.

Regarding the effects of $\beta 1b^{D103V}$ on $Na_v1.5$, we observed a decrease of the sodium current in the presence of this mutated subunit. We believe that this effect is not due to a lack of interaction between both subunits, since $\beta 1b^{D103V}$ also produced an acceleration in the recovery from inactivation. Thus, the decrease in $Na_v1.5$ current is not likely due to a lower expression of the $\beta 1b^{D103V}$ subunit but to an interaction between the α and β subunits at the plasma membrane.

1.2. Effect of $\beta 1^{D103V}$ and $\beta 1b^{D103V}$ on $Na_v1.1$ properties could impair normal neuronal activity

We show that the mutant $\beta 1$ subunit strongly decreased $Na_v1.1$ sodium current density compared to the WT $\beta 1$ subunit, which represents a loss of function of the channel, in agreement with Meadows *et al.*³¹ On the contrary, $\beta 1b^{D103V}$ did not have any effects on $Na_v1.1$ current density, but it shifted the voltage dependence of inactivation in the depolarizing direction, thus causing the channel to be available for activation in a larger voltage range. The observed reduction in the recovery from inactivation time constant caused by the $\beta 1b^{D103V}$ subunit also increases the availability of the channels for their activation. Assuming that $\beta 1b$ is normally present and interacts with $Na_v1.1$ in the native tissue⁶¹, both effects would contribute to gain of function of the channel. $\beta 1$ subunit mutations that induce a gain of function of $Na_v1.1$ have been reported to cause brain dysfunction.^{31,227} Thus, it is possible that $\beta 1b^{D103V}$ causes neuron hyperexcitability, destabilizing normal neuronal behavior of the brain. Also, given the importance of this subunit in brain development⁶², this mutation may impair brain formation at embryonic stages, provoking the brain phenotype at an early age, and may be involved in the patient's polymicrogyria.

Our results showed that the modulatory effects of $\beta 1^{D103V}$ and $\beta 1b^{D103V}$ on $Na_v1.1 I_{Na}$ are different, even opposing each other. Considering that $\beta 1b$ is predominantly expressed during embryonic development, we expect that the gain of function effect of $\beta 1b^{D103V}$ is more important during that stage. A loss of function caused by $\beta 1^{D103V}$ would be more important later in development. Therefore, since the *SCN1B_c.308A>T* SNV affects both $\beta 1$ and $\beta 1b$ isoforms, it could differentially compromise neuronal electrical activity during development.

2. The clinical manifestation of the $\beta 1$ and $\beta 1b$ subunit SNV is aggravated by the presence of other patient-specific mutations

Although the father and his children are carriers of the *SCN1B*_c.308A>T SNV, they displayed huge differences at the clinical level. While both the proband and his elder sister presented a complex clinical picture, the father was asymptomatic. This is an example of incomplete penetrance. To assess the second hypothesis of this study, regarding the influence of the genetic background on the phenotypical expression of a disease-causing mutation, we reviewed the whole exome data available for the proband to assess whether the effect of the SNV of this study on both neuronal and cardiac sodium currents could be affected by additional variants.

This family was part of a sequencing re-analysis project, from which the *SCN1B* variant along with variants in *POLR1C* were flagged as the best candidates that potentially contributed to the clinical phenotypes manifested by both the proband and his elder sister.²⁰⁷ Indeed, these two individuals carried the *SCN1B* SNV along with two SNVs in *POLR1C*.

The proband's father carries the c.88C>T SNV in *POLR1C* in heterozygosis along with the c.308A>T SNV in *SCN1B*, and his mother is heterozygous for the c.614delG SNV in *POLR1C*. Both mother and father are asymptomatic. Therefore, neither the *SCN1B* variant nor the *POLR1C* variants found in the proband could be the sole cause of his complex clinical picture. Indeed, the idea of monogenetic diseases has changed in recent years. Nowadays, it is accepted that genetic modifiers can cause phenotypic variability among individuals harboring the same mutation, and should be identified to perform an integrated clinical interpretation.²²⁸ As explained in **section 1.2.1 of the Introduction**, a mechanism, named the Knudson 2-hit, has been proposed to explain the incomplete penetrance in brain diseases.⁴² Thus, the *POLR1C* mutations as well as the variant located in *SCN1B* could have an accumulative effect to the phenotype.

POLR1C has been associated with autosomal recessive hypomyelinating leukodystrophy.²²⁹ This gene has also been described to cause recessive Treacher Collins syndrome 3 (OMIM #248390). Our proband did not show clinical manifestations of either of these conditions.²⁰⁷ However, the patient exhibited several neurological phenotypes consistent with *POLR1C* mutations, including hypomyelination, ataxia, and nystagmus, but the patient's other clinical

features are not described in *POLR1C* related cases. Thus, it is possible that the electrical disturbances observed in the patient are caused, at least in part, by the *POLR1C* mutations, and become aggravated by the loss of function of the sodium current caused by the *SCN1B* variant. Also, three-dimensional voltage mapping at baseline rhythm revealed extensive scarring of the right atrium and coronary sinus (**Figure 60**). Thus, electrical dysfunction potentially caused by the mutant $\beta 1$ and $\beta 1b$ subunits could be aggravated by a damaged tissue substrate.

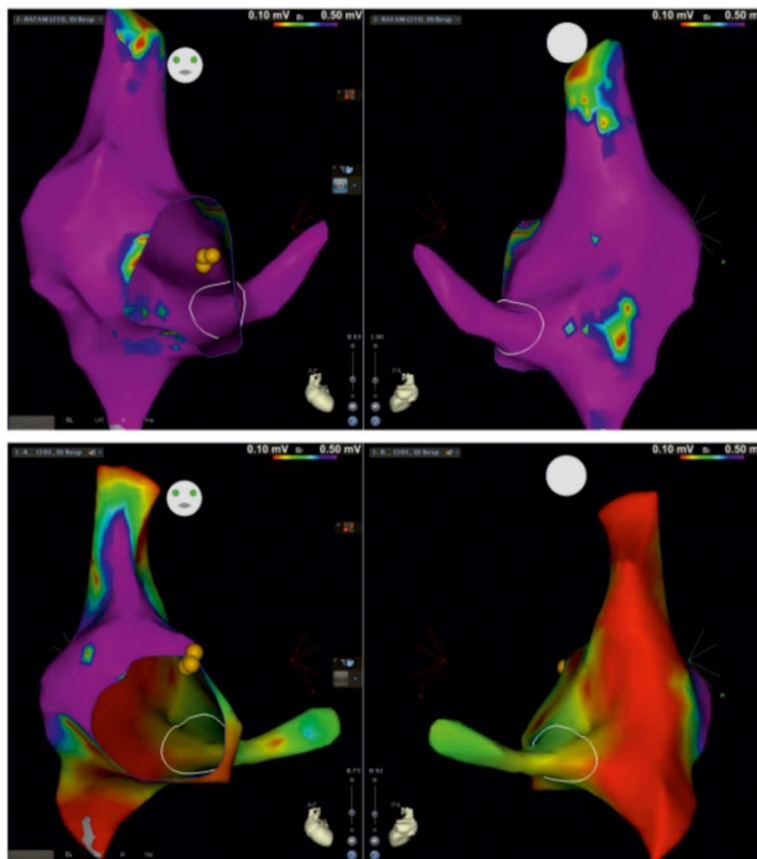

Figure 60. Intracardiac three-dimensional voltage mapping. Antero-posterior (left) and postero-anterior (right) projections of voltage map of right atrium and coronary sinus in baseline rhythm from the proband (top) and a healthy age-matched peer (bottom) for comparison (voltage color scale range: 0.1 – 0.5 mV, purple indicates voltage >0.5 mV). Adapted from Martinez-Moreno *et al.*²¹⁷

In summary, although the overall pathophysiology of the patient is complex, the $\text{Nav}1.5$ loss of function caused by the mutant $\beta 1$ subunit largely explains the clinical manifestations related to the patient's heart dysfunction. In addition, loss and gain of function of $\text{Nav}1.1$ caused by the $\beta 1$ and $\beta 1b$ mutant subunits might aggravate a brain condition caused by the combination of the two *POLR1C* mutations.

Study 2: *SCN5A* variant associated with Brugada Syndrome

In the second study of this Thesis, we presented the effect of the SNV *SCN5A_c.4573G>A* on the cardiac sodium channel properties. This SNV was identified in several members of a family, and had been previously related to BrS.¹⁸⁴ Our results in both HEK-293T cells and patient-specific iPS-CM showed a deleterious effect of this SNV on the sodium current. This suggests that the SNV may create a substrate for cardiac arrhythmias.

The following sections include a point-by-point discussion of our results in relation to our hypotheses.

1. The SNV *SCN5A_c.4573G>A* modifies the sodium current properties of the Nav1.5 channel

To assess the first hypothesis proposed for this study, we aimed to determine whether the SNV *SCN5A_c.4573G>A* had an effect on the electrophysiological properties of the cardiac Nav1.5 channel.

Mutations in the *SCN5A* gene have been implicated in several cardiac arrhythmogenic diseases, including LQT3, BrS, progressive cardiac conduction disease, dilated cardiomyopathy, sick sinus syndrome, AF and SIDS.¹⁶⁰ Furthermore, mutations in *SCN5A* account for 20-25% of the BrS cases.⁷⁷ Indeed, the first mutation associated to BrS was located in this gene.¹⁶⁷ Moreover, most of the BrS-associated mutations studied in heterologous models cause a loss of function of the cardiac sodium channel.^{77,160}

In our study, HEK-293T cells expressing the mutant Nav1.5 in heterozygosis showed a decrease in I_{Na} of 24.2%, compared to Nav1.5^{WT}. As expected, this decrease was further accentuated to a 46.9% when the SNV was expressed in homozygosis. In addition, τ slow was slightly increased when the SNV was expressed in heterozygosis at the 20 mV voltage.

Nav1.5^{V1525M} shifted the activation curve to more depolarizing potentials, compared to both Nav1.5^{WT} and Nav1.5^{WT/V1525M}. These data is in agreement with has been widely observed in mutations associated to BrS, recently reviewed by our group.⁷⁷

Surprisingly, while the recovery from inactivation time constant was unaffected when the SNV was expressed in homozygosis, it was increased in the heterozygous expression of the SNV.

Clatot *et al.* demonstrated that sodium channel α subunits form dimers through an interaction site located in the domain I-II linker. Furthermore, these dimers present coupled gating properties.²³⁰ Thus, the interaction between the mutant and WT α subunits in the heterozygous condition, could explain the increase observed in the recovery from inactivation time constant. This possible interaction between α subunits will be further discussed later in this section.

Overall, both the heterozygous and homozygous $\text{Na}_v1.5$ mutants lead to a loss of function of the channel. Our western blot data rules out the possibility that the WT and the heterozygous and homozygous mutants are expressed differently in the transfected cells. Thus, taking all these data into account, the loss of function observed in the mutant $\text{Na}_v1.5$ is likely due to a defective channel and not to a decrease in the number of channels.

2. The effect of the SNV on the sodium current properties of the $\text{Na}_v1.5$ channel is different in the three carrier individuals of the same family

From the clinical information that we had for the four individuals studied, we couldn't identify large phenotypical differences among the mutation carriers. Nevertheless, although the mother as well as her children are asymptomatic, the children are still younger than the average age for the onset of BrS symptoms. Thus, the absence of clinical manifestations of the disease cannot be taken as definitive. Moreover, the boy tested positive for flecainide while his sister tested negative. These differences were enough to prompt us to propose that the effect of the SNV on the sodium current properties of the $\text{Na}_v1.5$ channel would be different among the three carriers. To assess that, we studied the electrophysiological properties of $\text{Na}_v1.5$ in patient-specific iPS-CMs from the three SNV carriers and the non-carrier related control.

We observed that a high percentage of iPS-CM derived from the girl (Rb20234) and from the boy (Rb20235), both carriers of the SNV, did not show recordable I_{Na} . This was not observed in the iPS-CM derived from the mother (Rb20236), who is also a carrier of the SNV. To our knowledge, the lack of recordable I_{Na} has not been previously reported by any study using iPS-CM from BrS patients. The presence of increased number of cells with non-recordable I_{Na} could be caused by an enrichment of nodal cells in the cardiomyocyte population. It is known that this type of cells does not display $\text{Na}_v1.5$ current, and could have been obtained during

iPSc differentiation together with ventricular and atrial-type cells.²¹⁰ Our data assessing the expression of ventricular (*MYL2*), atrial (*MYL7*) and nodal (*HCN4*) markers does not support this interpretation, as the ratios between ventricular and nodal cells, and atrial and nodal cells are similar in the three SNV carriers in comparison to the father (control Rb20237).

Another possible explanation could be a decrease in sodium channel expression at the plasma membrane. This mechanism has been observed for several BrS-associated mutations. Unfortunately, we could not address this possibility for our iPSc-CM model, and it should be further investigated.

Taking all our results into account, a DN effect exerted by the SNV over the WT α subunit is the most plausible explanation for the lack of recordable I_{Na} in iPSc-CM from the girl and the boy. This reasoning will be further discussed ahead in this section.

We characterized the sodium current from the iPSc-CMs obtained from the girl and the boy that showed recordable I_{Na} . Whole cell current recordings showed a strong reduction of I_{Na} density in the iPSc-CM derived from both children, compared to the father's derived iPSc-CM which do not carry the SNV. This represents a loss of function of the current, which is in agreement with other studies performed with SNV-carrier BrS patient-specific iPSc-CM.^{85,91,203} Our data demonstrates that the loss of function observed in the children's derived iPSc-CM is not caused by a reduction of *SCN5A* expression. Nevertheless, this loss of function could be attributed to a deficiency at the protein translation level, which could not be assessed with our iPSc-CM model. τ fast was increased in both children's derived iPSc-CM at negative potentials. In addition, this parameter was also increased in the boy's derived iPSc-CM at more positive potentials. At more negative potentials, where the current peak is at its maximum value, this effect could be explained by the presence of the SNV. However, it could also be attributed to the fact that both patient-specific iPSc-CM displayed a small I_{Na} . At positive potentials the current is minimal, and thus the fitting of the time course is less accurate. Therefore, the observed difference may not be real and needs to be further investigated.

Selga *et al.*⁹¹, de la Roche *et al.*⁸⁵ and Li *et al.*²⁰³ reported a shift in the voltage dependence of activation curve in iPSc-CM from BrS related mutation carriers. We also observed this effect, but only in the children's derived iPSc-CM, compared to the father. In addition, the voltage dependence of steady-state inactivation curve was positively shifted in the iPSc-CM from the

children's derived iPS-CM. This is in contrast with the three afore mentioned studies, which show either a negative shift of the inactivation curve or no shift at all. The two effects that we report would further contribute to a loss of function of the Nav1.5 channel. In addition, the recovery from inactivation time constant was only increased in the iPS-CM derived from the girl. The explanation for this needs to be further investigated.

All these differences in the sodium current properties observed among the three SNV carriers iPS-CM strongly support the main hypothesis of this thesis, that states that the effect of sodium channel SNVs associated to inherited arrhythmogenic diseases is modulated by the individual's specific genetic background. The influence of the genetic background over the effects of the SNV on the cardiac sodium current will be further discussed in **section 4**.

Since the current reduction in the children's derived iPS-CM was greater than 50%, we suggest that the mutant channel could exert a DN effect over the WT Nav1.5. As previously mentioned, Clatot *et al.* reported that voltage-gated sodium channels α subunits physically interact, assembling, functioning and gating as dimers.²³⁰

Assuming that Nav1.5 α subunits interact, the proposed mechanism for the DN effect postulates that the mutant protein (known as dominant) is capable to inhibit the functions of the WT protein, causing it to be deficient.^{231,232} The DN effect can be caused by a trafficking-deficient channel²³³ or by an impaired coupled gating and gating probability of the WT and mutant channels.²³⁴ A DN effect of the Nav1.5 protein due to a BrS *SCN5A* SNV was first reported by Keller *et al.*¹⁹⁶, and several other studies have reported this effect since.^{78,233,235,236}

Taking this information into account, we surmise that the mutant Nav1.5 could exert a DN effect over the WT protein. Since the SNV in our study is carried in heterozygosis by three of the family members, the mutant protein could be preventing the WT to reach the plasma membrane and/or disrupt its gating properties. Either mechanism could explain the lack of recordable I_{Na} and the loss of function observed in the children's derived iPS-CM.

3. The effect of the SNV on the Nav1.5 current in the iPS-CM derived from carrier individuals of the same family is different to the effect observed in HEK-293T cells heterologously expressing the SNV

In our laboratory, we had previously characterized the electrophysiological properties of the sodium current in iPS-CM derived from a BrS patient who harbored a different SNV in *SCN5A*, and from HEK-293T transiently expressing this SNV. This study showed that HEK-293T failed to display all the changes in the sodium current properties observed in the iPS-CM.⁹¹ Similarly, de la Roche *et al.* also exposed that HEK-293T cells expressing an *SCN5A* SNV related to BrS failed to fully recapitulate the effects observed in iPS-CM derived from the patients harboring that SNV.⁸⁵

Based on these findings, as well as from other groups, we proposed our hypotheses stating that HEK-293T cells heterologously expressing the SNV would not replicate the effect of the SNV on the Nav_v1.5 current in the iPS-CM derived from carrier individuals. Thus, we used both HEK-293T and patient-specific iPS-CM as a cellular model. HEK-293T cells allow us to study the changes in the sodium current properties induced by the SNV. iPS-CM, in addition, provide both tissue and patient specificity, not present when the SNV is studied heterologously (Figure 61).

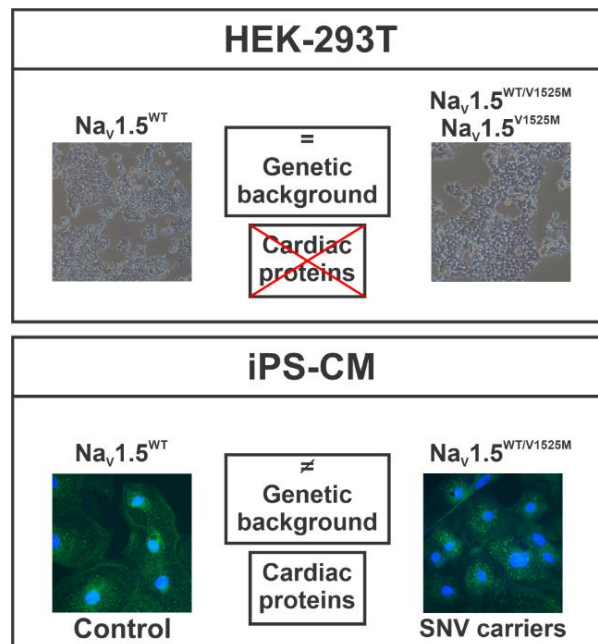

Figure 61. Cellular models used for the study of the SNV *SCN5A_c.4573G>A*. HEK-293T cells (up) share the same genetic background and do not express cardiac proteins; patient-specific iPS-CM (bottom) display different genetic background and express cardiac proteins.

Given that the SNV *SCN5A_c.4573G>A* is carried heterozygously by the three family individuals, we could expect that the effects over the sodium current properties would be similar to those observed in HEK-293T expressing Nav1.5^{WT/V1525M}. This is not what we observed. While the mother's derived iPS-CM showed a gain of function compared to the control, the children's derived iPS-CM displayed a dramatic loss of function of Nav1.5. This loss of function was greater than that observed in HEK-293T expressing the SNV in heterozygosis, and even in homozygosis.

Our results suggest that the differences detected in sodium current properties in both cellular models could be attributed to the presence of cell-specific molecules in iPS-CM that are absent in HEK-293T cells. Moreover, a DN effect mediated by a modulatory molecule could explain the disparity of the observed effects. Indeed, Mercier *et al.* demonstrated that β 1 subunits promote α - α subunit interaction in heterologous expression systems. This interaction leads to a DN effect when one of the α subunits harbors a SNV, that is not present when α subunits are expressed alone.²³⁵ Thus, the β 1-mediated DN effect would be present in patient-specific iPS-CM but not in HEK-293T cells, and this could explain the differences that we observed in the effects of the SNV on the sodium current properties in both cellular models. Although the β 1 subunit is a good candidate to explain these differences, it does not suffice to address the disparity of effects observed among mutation carriers. This will be further discussed in the following subsection.

4. The three carrier individuals of the same family hold other variants that could influence the cellular phenotypical effect of the SNV

As previously exposed, our data revealed a dramatic loss of function in the children's derived iPS-CM, not observed in the mother's. Thus, we hypothesized that other individual-specific variants could influence the cellular phenotypical effect of the SNV. We performed a genetic panel which included genes related to cardiac arrhythmias with the iPSc of the four members of the family. This allowed us to identify other variants in each of the individuals. The information provided by the panel opens some possible explanations on how different variants may impact the effects of the SNV on the sodium current characteristics and clinical phenotype in the SNV carriers.

The genetic panel revealed that the mother was the only carrier of the SNV *SCN5A_c.1673A>G* (**Annex Table 25**). This genetic change leads to Nav1.5_p.H558R, which is a common polymorphism present in 20-32% in the white population, 29% in the black population and 10.4% in the Chinese population.²³⁷ In vitro studies proved that this polymorphism modulates the effect of other mutations in *SCN5A*, even when those are located in a different allele.^{238,239} Furthermore, different studies provided evidences that Nav1.5_p.H558R fully or partially restores I_{Na} impaired by co-expressed mutants, thus acting as a disease-modifying gene.^{232,239,240} The improved sodium channel activity in mutated channels could be caused either by the polymorphism's ability to modify mutant Nav1.5 gating kinetics or by its role in rescuing trafficking abnormalities.²³⁹⁻²⁴¹ Matsumura *et al.* proposed that Nav1.5_p.H558R could be modulating *SCN5A* expression and methylation, thus offering protection against the occurrence of ventricular fibrillation in BrS patients.²¹⁶ In addition, Lizotte *et al.* demonstrated that it also modulates the electrocardiographic and clinical parameters in BrS patients.²³⁷

Thus, taking all these data into account, the presence of this polymorphism in the mother could explain the absence of the Nav1.5 loss of function in the iPS-CM obtained from her. Furthermore, the lack of any clinical manifestations in the mother could also be explained by the modulatory role of this polymorphism on cardiac sodium current properties in the context of the SNV *SCN5A_c.4573G>A*. It is worth noting that the iPS-CM derived from her children, who do not carry this protective polymorphism, displayed a dramatic Nav1.5 loss of function. Thus, the two children should be carefully clinically monitored in the future.

Both siblings showed clinical dissimilarities. While the boy tested positive for flecainide, which unmasked the BrS ECG pattern, his sister tested negative. Since the loss of function of the cardiac sodium channel observed in the iPS-CM obtained from both individuals was similar, we speculate that variants other than the shared SNV *SCN5A_c.4573G>A* could be causing the clinical differences.

We found some genetic differences between the siblings. Although none on their own helps us to explain the dissimilarities that we observed in the sodium current properties among the iPS-CM derived from the three carriers of the family, and taking into account that their effects on the sodium current properties have not been characterized, there are some variants that are worth discussing.

The girl carries a SNV in the gene *CACNB2* (**Results Table 39**), which encodes the β subunit of the L-type sodium current ($Ca_v\beta 2$). While loss of function mutations in *CACNB2* have been associated to BrS²⁴², Hu *et al.* reported a polymorphism that caused a gain of function of I_{Ca} by slowing its inactivation. In that study, the patients carried an SNV in *SCN5A* as well as the polymorphism in *CACNB2*, but none displayed the BrS ECG.²⁴³ Moreover, it has been demonstrated that an increase in I_{Ca} mediated by the administration of some drugs suppresses the BrS phenotype. In the ECG, I_{Ca} increment avoids loss of the AP dome or restores it, preventing the development of ST elevation.²⁴⁴

The SNV in *CACNB2* identified in the girl has not been previously reported nor characterized, thus we do not know if it causes either a loss of function or a gain of function of I_{Ca} . Nevertheless, if it was the latter case, it could be suppressing the BrS ECG, which could explain the difference in the flecainide test between she and her brother. A functional characterization of this variant in a cellular model such as HEK-293T cells or iPS-CM could elucidate its role.

The boy carries common variants in the genes *MYBPC3*, *MYH6*, *MYH7* and *TNNI3* that were not identified in the other family members (**Annex Table 24**). Mutations in these genes have been related to Hypertrophic Cardiomyopathy, which is characterized by similar abnormalities in the ECG as BrS, including an abnormal ST segment and negative T waves.^{245,246} Although all these variants are reported to be likely benign, in the context of the damaged cellular phenotype observed in the boy they could be contributing to the observed response to flecainide, either by compromising the heart conductivity or the junction between cardiomyocytes, and thus affecting the ECG.

Alterations in the *PKP2* gene, encoding for the protein plakophilin-2, have been associated principally to arrhythmogenic cardiomyopathy (AC).²⁴⁷ Nevertheless, Corrado *et al.* reported that AC may present phenotypic features typically observed in BrS patients, such as non-exercise-related cardiac arrest and polymorphic ventricular tachycardia.²⁴⁸ In 2014, Cerrone *et al.* suggested that *PKP2* mutations may be involved in BrS, as this gene interacts with the voltage-gated sodium channel complex.²⁴⁹ Additionally, they had already demonstrated in 2012 that a mouse model of haploinsufficiency for *PKP2* displayed I_{Na} deficit, leading to flecainide-induced ventricular arrhythmias and SCD.²⁵⁰ Thus, similar to the previously

discussed set of genes, the variant identified in the boy in *PKP2* (**Annex Table 24**) could be modifying the son's ECG.

Although the variants discussed in these genes carried by the children are not conclusive and would need further investigation, they could potentially explain the differences observed between them in the flecainide test.

In summary, the *SCN5A_c.4573G>A* SNV causes a loss of function of Na_v1.5 in both studied cellular models. This effect was greater in the children's derived iPS-CM than in HEK-293T cells, possibly due to the fact that iPS-CM carry both tissue specificity and patient-specific background. Since the mother's derived iPS-CM did not display this loss of function, other genetic variants identified in the genetic panel may be modulating the cellular phenotype. These identified variants could be preventing the Na_v1.5 loss of function in the iPS-CM derived from the mother, and contributing to the differences observed in the flecainide test of the siblings.

Overall discussion

It is known that several channelopathies have an underlying genetic component.²⁵¹ To date, genetic analysis has been the principal approach to identify mutations in individuals affected by channelopathies. Furthermore, a genetic diagnosis enables clarification of the risk for relatives, in special the asymptomatic ones.²⁵¹ Nevertheless, some channelopathies display incomplete penetrance and variable expressivity, probably due to a combination of genetic, environmental and lifestyle factors. Additionally, rare and/or common variants located in the same gene or even another one can modify the cellular phenotype caused by a disease-linked mutation. All these variables represent additional challenges in the interpretation of genetic results, and should thus be taken in context of all the clinical information and familiar history.^{251,252}

Having all this information in mind, and focusing in diseases potentially caused by alterations in the voltage gated sodium channels, we formulated the main hypothesis of this Thesis. We stated that the individual's specific genetic background modulates the effect of sodium channel SNVs linked to arrhythmogenic diseases, which could explain the incomplete penetrance and variable expressivity of a given SNV in a family. The study of the two SNVs characterized in this Thesis provides evidence for a role of patient-specific genetic background in the clinical phenotype caused by a given mutation.

Both studied SNVs were identified in families displaying incomplete penetrance. The SNVs, when expressed heterologously in HEK-293T cells, altered the biophysical properties of the studied sodium channels: $\text{Na}_v1.5$ and $\text{Na}_v1.1$ in the study involving the $\beta1/\beta1b$ subunits SNV, and $\text{Na}_v1.5$ in the study of the *SCN5A* SNV. Furthermore, the *SCN5A* SNV displayed cellular phenotypical variability in the iPS-CM derived from the iPSc from the three carriers. While a dramatic loss of function of the channel in the children's derived iPS-CM was observed, such effect was not seen in those derived from the mother.

In both studies, additional analyses involving whole exome sequencing in the first study and a genetic panel in the second, allowed us to discuss the possible reasons behind such variability. In the first study, two variants in the *POLR1C* gene were identified, and could modulate the complex clinical phenotype observed in the proband and his deceased elder sister.

In the second study, we identified other variants that could account for the phenotypical differences observed between the *SCN5A* SNV carrier individuals. However, since these variants have not been studied, it remains to be elucidated their possible implication as sodium current modulators, and the mechanisms by which these regulatory effects would impact I_{Na} in the context of the *SCN5A* SNV. It has been described in BrS cases that the function of the $Nav1.5$ channel can potentially be affected by other variants that interact with the channel.²⁴⁹ Accumulation of genetic variants may modulate disease susceptibility, suggesting that the currently accepted Mendelian inheritance for BrS should be replaced with a polygenic or oligogenic model.²⁵³ The results presented in this thesis further support this oligogenic model of inheritance for BrS.

Therefore, future studies regarding channelopathies that display incomplete penetrance in a family with a known disease-causing mutation should further explore the presence of other variants that could be modulating its phenotypical expression.

VII. Conclusions

1. The SNV *SCN1B*_c.308A>T located in the $\beta 1$ and $\beta 1b$ subunits causes a loss of function of the cardiac-type sodium current, which could explain the clinical presentation of progressive atrial standstill, intra-atrial reentrant tachycardia, and cardiac conduction disorder in the proband of the first family studied.
2. The *SCN1B* SNV could contribute to the proband's brain phenotype at two different stages. The gain of function of the brain-type sodium channel caused by the mutant $\beta 1b$ could affect the brain during development and early life, when the $\beta 1b$ isoform is predominant. During adulthood, when the $\beta 1$ subunit is predominantly expressed, the loss of function produced by the mutant $\beta 1$ of the $Nav1.1$ sodium current could lead to arrhythmogenic brain activity.
3. Loss and gain of function of $Nav1.1$ caused by the $\beta 1$ and $\beta 1b$ mutant subunits might aggravate a brain condition caused by the combination of the two *POLR1C* mutations that the patient inherited from his father and mother.
4. The heterologous expression of the SNV *SCN5A*_c.4573G>A in HEK-293T cells causes a loss of function of the $Nav1.5$ channel. The children-derived iPS-CM, which carry the SNV, also showed a loss of function of the cardiac sodium channel, but the magnitude of the effect of the SNV was greater in this cellular model.
5. The differences observed between HEK-293T cells and patient-specific iPS-CM expressing the same SNV can be explained by the fact that iPS-CM provide cardiac tissue specificity. This implies that other molecules interacting with the α subunit can further modify the deleterious effect of the SNV.
6. The loss of function of $Nav1.5$ observed in the iPS-CM obtained from both the girl and the boy of the second family studied was greater than 50% respect to their father's (non-carrier) derived cells. Since the SNV is carried in heterozygous form in the family, this larger than expected effect of the mutation could be interpreted as a dominant negative effect of the mutant channel over the WT $Nav1.5$ α subunit.
7. Patient-specific genetic background modulates the effect of the SNV in iPS-CM:
 - a. The mother carries the polymorphism $Nav1.5$ _p.H558R, that could be protecting the sodium channel from the deleterious effect of the mutation, explaining the lack of loss of function observed in her derived iPS-CM.

- b.** To date, both children also remain clinically asymptomatic, although the boy tested positive to a flecainide test, which unmasked the BrS ECG. The differences observed in the flecainide test between the girl and the boy could be influenced by other variants identified in the genetic panel. Given that BrS symptoms appear in the adulthood, both children could develop clinical manifestations in the future.
- 8.** Overall, we conclude that incomplete penetrance and variable expressivity observed within families carrying a disease-causing mutation are highly subject to modulation by patient-specific variants, other than the main identified SNV. Thus, the pathogenicity of a mutation in a family should be addressed by assessing the presence of other variants that could modulate its phenotypical expression.

VIII. Bibliography

1. Kim, J.-B. Channelopathies. *Korean J Pediatr* **57**, 1–18 (2014).
2. Bartolini, E. *et al.* Epilepsy and brain channelopathies from infancy to adulthood. *Neurol. Sci.* **41**, 749–761 (2020).
3. Amin, A. S., Tan, H. L. & Wilde, A. A. M. Cardiac ion channels in health and disease. *Hear. Rhythm* **7**, 117–126 (2010).
4. Giudicessi, J. R. & Ackerman, M. J. Determinants of incomplete penetrance and variable expressivity in heritable cardiac arrhythmia syndromes. *Transl Res.* **161**, 1–14 (2013).
5. Giudicessi, J. R. & Ackerman, M. J. Genetic testing in heritable cardiac arrhythmia syndromes: differentiating pathogenic mutations from background genetic noise. *Curr. Opin. Cardiol.* **28**, 63–71 (2013).
6. Ackerman, M. J. *et al.* HRS/EHRA expert consensus statement on the state of genetic testing for the channelopathies and cardiomyopathies. *Europace* **13**, 1077–1109 (2011).
7. Jitpimolmard, N., Matthews, E. & Fialho, D. Treatment Updates for Neuromuscular Channelopathies. *Curr. Treat. Options Neurol.* **22**, 1–20 (2020).
8. Vivekanandam, V., Munot, P., Hanna, M. G. & Matthews, E. Skeletal Muscle Channelopathies. *Neurol. Clin.* **38**, 481–491 (2020).
9. Johnson, J. N. *et al.* Identification of a possible pathogenic link between congenital long QT syndrome and epilepsy. *Neurology* **72**, 224–231 (2009).
10. Bagnall, R. D. *et al.* Exome-based analysis of cardiac arrhythmia, respiratory control, and epilepsy genes in sudden unexpected death in epilepsy. *Ann. Neurol.* **79**, 522–534 (2016).
11. Tu, E., Bagnall, R. D., Duflou, J. & Semsarian, C. Post-mortem review and genetic analysis of sudden unexpected death in epilepsy (SUDEP) cases. *Brain Pathol.* **21**, 201–208 (2011).
12. Tiron, C. *et al.* Further evidence of the association between LQT syndrome and epilepsy in a family with KCNQ1 pathogenic variant. *Seizure* **25**, 65–67 (2015).
13. Haugaa, K. H. *et al.* Abnormal electroencephalograms in patients with long QT syndrome. *Hear. Rhythm* **10**, 1–25 (2013).
14. Fan, R. *et al.* Concomitant presentation of Anderson-Tawil syndrome and myasthenia gravis in an adult patient: A case report. *Exp. Ther. Med.* **12**, 2435–2438 (2016).
15. Parisi, P. *et al.* Coexistence of epilepsy and Brugada syndrome in a family with SCN5A mutation. *Epilepsy Res.* **105**, 415–418 (2013).
16. Ryan, D. P. & Ptáček, L. J. Episodic neurological channelopathies. *Neuron* **68**, 282–292 (2010).
17. Nappi, P. *et al.* Epileptic channelopathies caused by neuronal Kv7 (KCNQ) channel dysfunction. *Pflugers Arch. Eur. J. Physiol.* **472**, 881–898 (2020).
18. D’adamo, M. C., Liantonio, A., Rolland, J. F., Pessia, M. & Imbrici, P. Kv1.1 channelopathies: Pathophysiological mechanisms and therapeutic approaches. *Int. J.*

- Mol. Sci.* **21**, 1–21 (2020).
19. Bailey, C. S., Moldenhauer, H. J., Park, S. M., Keros, S. & Meredith, A. L. KCNMA1 - linked channelopathy. *J. Gen. Physiol.* **151**, 1173–1189 (2019).
 20. Lory, P., Nicole, S. & Monteil, A. Neuronal Cav3 channelopathies: recent progress and perspectives. *Pflugers Arch. Eur. J. Physiol.* **472**, 831–844 (2020).
 21. Marcantoni, A., Calorio, C., Hidisoglu, E., Chiantia, G. & Carbone, E. Cav1.2 channelopathies causing autism: new hallmarks on Timothy syndrome. *Pflugers Arch. Eur. J. Physiol.* **472**, 775–789 (2020).
 22. Weiss, N. & Zamponi, G. W. Genetic T-type calcium channelopathies. *J. Med. Genet.* **57**, 1–10 (2020).
 23. Menezes, L. F. S., Sabiá Júnior, E. F., Tibery, D. V., Carneiro, L. dos A. & Schwartz, E. F. Epilepsy-Related Voltage-Gated Sodium Channelopathies: A Review. *Front. Pharmacol.* **11**, 1–32 (2020).
 24. Kruth, K. A., Grisolano, T. M., Ahern, C. A. & Williams, A. J. SCN2A channelopathies in the autism spectrum of neuropsychiatric disorders: A role for pluripotent stem cells? *Mol. Autism* **11**, 1–11 (2020).
 25. Matthews, E., Balestrini, S., Sisodiya, S. M. & Hanna, M. G. Muscle and brain sodium channelopathies: genetic causes, clinical phenotypes, and management approaches. *Lancet Child Adolesc. Heal.* **4**, 1–12 (2020).
 26. Scheffer, I. E. & Nabbout, R. SCN1A-related phenotypes: Epilepsy and beyond. *Epilepsia* **60**, S17–S24 (2019).
 27. Kaplan, D. I., Isom, L. L. & Petrou, S. Role of sodium channels in epilepsy. *Cold Spring Harb. Perspect. Med.* **6**, 1–18 (2016).
 28. Barela, A. J. *et al.* An epilepsy mutation in the sodium channel SCN1A that decreases channel excitability. *J. Neurosci.* **26**, 2714–2723 (2006).
 29. Cossette, P. *et al.* Functional characterization of the D188V mutation in neuronal voltage-gated sodium channel causing generalized epilepsy with febrile seizures plus (GEFS). *Epilepsy Res.* **53**, 107–117 (2003).
 30. Brunklaus, A. *et al.* SCN1A variants from bench to bedside—improved clinical prediction from functional characterization. *Hum. Mutat.* 1–12 (2019) doi:10.1002/humu.23943.
 31. Meadows, L. S. *et al.* Functional and biochemical analysis of a sodium channel β 1 subunit mutation responsible for generalized epilepsy with febrile seizures plus type 1. *J. Neurosci.* **22**, 10699–10709 (2002).
 32. Tammaro, P., Conti, F. & Moran, O. Modulation of sodium current in mammalian cells by an epilepsy-correlated β 1-subunit mutation. *Biochem. Biophys. Res. Commun.* **291**, 1095–1101 (2002).
 33. Xu, R. *et al.* Generalized epilepsy with febrile seizures plus-associated sodium channel β 1 subunit mutations severely reduce beta subunit-mediated modulation of sodium channel function. *Neuroscience* **148**, 164–174 (2007).
 34. Patino, G. A. *et al.* A functional null mutation of SCN1B in a patient with Dravet

- syndrome. *J. Neurosci.* **29**, 10764–10778 (2009).
35. Wallace, R. H. *et al.* Febrile seizures and generalized epilepsy associated with a mutation in the Na⁺-channel β 1 subunit gene SCN1B. *Nat. Genet.* **19**, 366–370 (1998).
 36. Gourraud, J. B. *et al.* The Brugada Syndrome: A Rare Arrhythmia Disorder with Complex Inheritance. *Front. Cardiovasc. Med.* **3**, 1–11 (2016).
 37. Scicluna, B. P., Wilde, A. W. & Bezzina, C. R. The primary arrhythmia syndromes: Same mutation, different manifestations. Are we starting to understand why? *J. Cardiovasc. Electrophysiol.* **19**, 445–452 (2008).
 38. Campuzano, O. *et al.* Genetics and cardiac channelopathies. *Genet. Med.* **12**, 260–267 (2010).
 39. Van Den Boogaard, M. *et al.* Genetic variation in T-box binding element functionally affects SCN5A / SCN10A enhancer Find the latest version : Genetic variation in T-box binding element functionally affects SCN5A / SCN10A enhancer. *J. Clin. Invest.* **122**, 2519–2530 (2012).
 40. Van Den Boogaard, M. *et al.* A common genetic variant within SCN10A modulates cardiac SCN5A expression. *J. Clin. Invest.* **124**, 1844–1852 (2014).
 41. Bezzina, C. R. *et al.* Common sodium channel promoter haplotype in Asian subjects underlies variability in cardiac conduction. *Circulation* **113**, 338–344 (2006).
 42. Fernández-Marmiesse, A. *et al.* Rare Variants in 48 Genes Account for 42% of Cases of Epilepsy With or Without Neurodevelopmental Delay in 246 Pediatric Patients. *Front. Neurosci.* **13**, 1–17 (2019).
 43. Sarquella-Brugada, G., Campuzano, O., Arbelo, E., Brugada, J. & Brugada, R. Brugada syndrome: Clinical and genetic findings. *Genet. Med.* **18**, 3–12 (2016).
 44. Probst, V. *et al.* Clinical aspects and prognosis of Brugada syndrome in children. *Circulation* **115**, 2042–2048 (2007).
 45. Tran, C. H. *et al.* Interneuron desynchronization precedes seizures in a mouse model of Dravet syndrome. *J. Neurosci.* **40**, 2764–2775 (2020).
 46. Mei, D., Cetica, V., Marini, C. & Guerrini, R. Dravet syndrome as part of the clinical and genetic spectrum of sodium channel epilepsies and encephalopathies. *Epilepsia* **60**, S2–S7 (2019).
 47. Vernooy, K. *et al.* Genetic and biophysical basis for bupivacaine-induced ST segment elevation and VT/VF. Anesthesia unmasked Brugada syndrome. *Hear. Rhythm* **3**, 1074–1078 (2006).
 48. Wood, J. N. & Iseppon, F. Sodium channels. *Brain Neurosci. Adv.* **2**, 239821281881068 (2018).
 49. Hille, B. *Ion Channels of Excitable Membranes.* (Sinauer Associates, Inc., 2001).
 50. Hodgkin, A. L. & Huxley, A. F. A QUANTITATIVE DESCRIPTION OF MEMBRANE CURRENT AND ITS APPLICATION TO CONDUCTION AND EXCITATION IN NERVE. *J. Physiol* **117**, 500–544 (1952).
 51. Beneski, D. A. & Catterall, W. A. Covalent labeling of protein components of the

- sodium channel with a photoactivable derivative of scorpion toxin. *Proc. Natl. Acad. Sci. U. S. A.* **77**, 639–643 (1980).
52. Catterall, W. A. Forty Years of Sodium Channels: Structure, Function, Pharmacology, and Epilepsy. *Neurochem. Res.* **42**, 2495–2504 (2017).
 53. Hille, B. *Ion Channels of Excitable Membranes*. (Sinauer associates, Inc, 2001). doi:10.1007/3-540-29623-9_5640.
 54. Bertrand, D. *et al.* Functional studies of sodium channels: From target to compound identification. *Curr. Protoc. Pharmacol.* **2016**, 9.21.1-9.21.35 (2016).
 55. De Lera Ruiz, M. & Kraus, R. L. Voltage-Gated Sodium Channels: Structure, Function, Pharmacology, and Clinical Indications. *J. Med. Chem.* **58**, 7093–7118 (2015).
 56. Amin, A. S., Verkerk, A. O., Bhuiyan, Z. A., Wilde, A. A. M. & Tan, H. L. Novel Brugada syndrome-causing mutation in ion-conducting pore of cardiac Na⁺ channel does not affect ion selectivity properties. *Acta Physiol. Scand.* **185**, 291–301 (2005).
 57. Catterall, W. A. From ionic currents to molecular mechanisms: The structure and function of voltage-gated sodium channels. *Neuron* **26**, 13–25 (2000).
 58. Heinemann, S. H., Terlau, H., Stuhmer, W., Imoto, K. & Numa, S. Calcium channel characteristics conferred on the sodium channel by single mutations. *Nature* **359**, 441–443 (1992).
 59. Vetter, I. *et al.* NaV1.7 as a pain target – From gene to pharmacology. *Pharmacol. Ther.* **16**, 1–117 (2016).
 60. Catterall, W. A. Structure and Function of Voltage-Gated Sodium Channels at Atomic Resolution. *Exp Physiol.* **99**, 1–26 (2014).
 61. Kazen-Gillespie, K. A. *et al.* Cloning, localization, and functional expression of sodium channel β 1A subunits. *J. Biol. Chem.* **275**, 1079–1088 (2000).
 62. O’Malley, H. A. & Isom, L. L. Sodium channel β subunits: Emerging targets in channelopathies. *Annu. Rev. Physiol.* **77**, 481–504 (2015).
 63. Patino, G. A. *et al.* Voltage-gated Na⁺ channel β 1B: A secreted cell adhesion molecule involved in human epilepsy. *J. Neurosci.* **31**, 14577–14591 (2011).
 64. Patino, G. A. & Isom, L. L. Electrophysiology and beyond: Multiple roles of Na⁺ channel β subunits in development and disease. *Neurosci. Lett.* **486**, 53–59 (2010).
 65. Boron, W. F. & Boulpaep, E. L. *Medical Physiology. A cellular and molecular approach* (Saunders Elsevier, 2012). doi:10.1017/CBO9781107415324.004.
 66. Ogden, D. *Microelectrode Techniques: The Plymouth Workshop Handbook*. (The Company of Biologists Limited, 1994).
 67. Hamill, O. P., Marty, A., Neher, E., Sakmann, B. & Sigworth, F. J. Improved patch-clamp techniques for high-resolution current recording from cells and cell-free membrane patches. *Pflügers Arch. Eur. J. Physiol.* **391**, 85–100 (1981).
 68. Neher, E. & Sakmann, B. Single-channel currents recorded from membrane of denervated frog muscle fibres. *Nature* **260**, 799–802 (1976).
 69. Bezanilla, F. Gating currents. *J. Gen. Physiol.* **150**, 911–932 (2018).

70. Aldrich, R. W., Corey, D. P. & Stevens, C. F. A reinterpretation of mammalian sodium channel gating based on single channel recording. *Nature* **306**, 436–441 (1983).
71. Horn, R. & Vandenberg, C. A. Statistical properties of single sodium channels. *J. Gen. Physiol.* **84**, 505–534 (1984).
72. Bezanilla, F. & Armstrong, C. M. Inactivation of the sodium channel. I. Sodium Current Experiments. *J. Gen. Physiol.* **70**, 549–566 (1977).
73. Xu, L. *et al.* Voltage-gated sodium channels: structures, functions, and molecular modeling. *Drug Discov. Today* **24**, 1389–1397 (2019).
74. Papadatos, G. A. *et al.* Slowed conduction and ventricular tachycardia after targeted disruption of the cardiac sodium channel gene *Scn5a*. *Proc. Natl. Acad. Sci. U. S. A.* **99**, 6210–6215 (2002).
75. Remme, C. A. *et al.* Overlap syndrome of cardiac sodium channel disease in mice carrying the equivalent mutation of human SCN5A-1795insD. *Circulation* **114**, 2584–2594 (2006).
76. Mantegazza, M. & Broccoli, V. SCN1A/NaV1.1 channelopathies: Mechanisms in expression systems, animal models, and human iPSC models. *Epilepsia* **60**, S25–S38 (2019).
77. Sendfeld, F. *et al.* Experimental models of brugada syndrome. *Int. J. Mol. Sci.* **20**, (2019).
78. Park, D. S. *et al.* Genetically engineered SCN5A mutant pig hearts exhibit conduction defects and arrhythmias. *J. Clin. Invest.* **125**, 403–412 (2015).
79. Yan, G. X. & Antzelevitch, C. Cellular basis for the electrocardiographic J wave. *Circulation* **93**, 372–379 (1996).
80. Nishida, K. *et al.* Canine model of Brugada syndrome using regional epicardial cooling of the right ventricular outflow tract. *J. Cardiovasc. Electrophysiol.* **15**, 936–941 (2004).
81. Morita, H. *et al.* Repolarization heterogeneity in the right ventricular outflow tract: Correlation with ventricular arrhythmias in Brugada patients and in an in vitro canine Brugada model. *Hear. Rhythm* **5**, 725–733 (2008).
82. Schutte, S. S., Schutte, R. J., Barragan, E. V. & O’Dowd, D. K. Model systems for studying cellular mechanisms of SCN1A-related epilepsy. *J. Neurophysiol.* **115**, 1755–1766 (2016).
83. Griffin, A. *et al.* Preclinical animal models for Dravet syndrome: Seizure phenotypes, comorbidities and drug screening. *Front. Pharmacol.* **9**, 1–15 (2018).
84. Bezanilla, F. Ion Channels: From Conductance to Structure. *Neuron* **60**, 456–468 (2008).
85. de la Roche, J. *et al.* Comparing human iPSC-cardiomyocytes versus HEK293T cells unveils disease-causing effects of Brugada mutation A735V of NaV1.5 sodium channels. *Sci. Rep.* **9**, 1–14 (2019).
86. Deschênes, I. *et al.* Electrophysiological characterization of SCN5A mutations causing long QT (E1784K) and Brugada (R1512W and R1432G) syndromes. *Cardiovasc. Res.*

- 46, 55–65 (2000).
87. Goldberg-Stern, H. *et al.* Broad phenotypic heterogeneity due to a novel SCN1A mutation in a family with genetic epilepsy with febrile seizures plus. *J. Child Neurol.* **29**, 221–226 (2014).
 88. Groenewegen, W. A. *et al.* A novel LQT3 mutation implicates the human cardiac sodium channel domain IVS6 in inactivation kinetics. *Cardiovasc. Res.* **57**, 1072–1078 (2003).
 89. Makita, N. *et al.* The E1784K mutation in SCN5A is associated with mixed clinical phenotype of type 3 long QT syndrome. *J. Clin. Invest.* **118**, 2219–2229 (2008).
 90. Ruan, Y. *et al.* Trafficking defects and gating abnormalities of a novel SCN5A mutation question gene-specific therapy in long QT syndrome type 3. *Circ. Res.* **106**, 1374–1383 (2010).
 91. Selga, E. *et al.* Sodium channel current loss of function in induced pluripotent stem cell-derived cardiomyocytes from a Brugada syndrome patient. *J. Mol. Cell. Cardiol.* **114**, 10–19 (2018).
 92. Tarradas, A. *et al.* A Novel Missense Mutation, I890T, in the Pore Region of Cardiac Sodium Channel Causes Brugada Syndrome. *PLoS One* **8**, 1–10 (2013).
 93. Lossin, C. *et al.* Epilepsy-Associated Dysfunction in the Voltage-Gated Neuronal Sodium Channel SCN1A. *J. Neurosci.* **23**, 11289–11295 (2003).
 94. Gurdon, J. B., Elsdale, T. R. & Fischberg, M. Sexually mature individuals of *Xenopus laevis* from the transplantation of single somatic nuclei. *Nature* **182**, 64–65 (1958).
 95. GURDON, J. B. The developmental capacity of nuclei taken from intestinal epithelium cells of feeding tadpoles. *J. Embryol. Exp. Morphol.* **10**, 622–640 (1962).
 96. Kaufman, M. H. & Evans, M. J. Establishment in culture of pluripotential cells from mouse embryos. *Nature* **292**, 154–156 (1981).
 97. Martin, G. R. Isolation of a pluripotent cell line from early mouse embryos cultured in medium conditioned by teratocarcinoma stem cells. *Proc. Natl. Acad. Sci. U. S. A.* **78**, 7634–7638 (1981).
 98. Tada, M., Takahama, Y., Abe, K., Nakatsuji, N. & Tada, T. Nuclear reprogramming of somatic cells by in vitro hybridization with ES cells. *Curr. Biol.* **11**, 1553–1558 (2001).
 99. Cowan, C. A., Atienza, J., Melton, D. A. & Eggan, K. Nuclear reprogramming of somatic cells after fusion with human embryonic stem cells. *Science (80-)*. **309**, 1369–1373 (2005).
 100. Takahashi, K. & Yamanaka, S. Induction of Pluripotent Stem Cells from Mouse Embryonic and Adult Fibroblast Cultures by Defined Factors. *Cell* **126**, 663–676 (2006).
 101. Takahashi, K. *et al.* Induction of Pluripotent Stem Cells from Adult Human Fibroblasts by Defined Factors. *Cell* **131**, 861–872 (2007).
 102. Yu, J. *et al.* Induced pluripotent stem cell lines derived from human somatic cells. *Science* vol. 318 (2007).

103. Liu, Y. *et al.* Directed differentiation of forebrain GABA interneurons from human pluripotent stem cells. *Nat. Protoc.* **8**, 1670–1679 (2013).
104. Maroof, A. M. *et al.* Directed differentiation and functional maturation of cortical interneurons from human embryonic stem cells. *Cell Stem Cell* **12**, 559–572 (2013).
105. Nicholas, C. R. *et al.* Functional maturation of hPSC-derived forebrain interneurons requires an extended timeline and mimics human neural development. *Cell Stem Cell* **12**, 573–586 (2013).
106. Stover, A. E. *et al.* Process-Based Expansion and Neural Differentiation of Human Pluripotent Stem Cells for Transplantation and Disease Modeling. *J Neurosci Res* **91**, 1247–1262 (2013).
107. Zhang, Y. *et al.* Rapid Single-Step Induction of Functional Neurons from Human Pluripotent Stem Cells. *Neuron* **78**, 785–798 (2013).
108. Bossolasco, P. *et al.* Motor neuron differentiation of iPSCs obtained from peripheral blood of a mutant TARDBP ALS patient. *Stem Cell Res.* **30**, 61–68 (2018).
109. McKinney, C. E. Using induced pluripotent stem cells derived neurons to model brain diseases. *Neural Regen. Res.* **12**, 1062–1067 (2017).
110. Mertens, J., Marchetto, M. C., Bardy, C. & Gage, F. H. Evaluating cell reprogramming, differentiation and conversion technologies in neuroscience. *Nat. Rev. Neurosci.* **17**, 424–437 (2016).
111. Zhang, X., Li, Z., Liu, Y. & Gai, Z. Great expectations: Induced pluripotent stem cell technologies in neurodevelopmental impairments. *Int. J. Med. Sci.* **18**, 459–473 (2020).
112. Hirose, S. *et al.* Application of induced pluripotent stem cells in epilepsy. *Mol. Cell. Neurosci.* **108**, 1–32 (2020).
113. Higurashi, N. *et al.* A human Dravet syndrome model from patient induced pluripotent stem cells. *Mol. Brain* **6**, 1–12 (2013).
114. Liu, Y. *et al.* DRAVET SYNDROME PATIENT-DERIVED NEURONS SUGGEST A NOVEL EPILEPSY MECHANISM. *Ann. Neurol.* **74**, 128–139 (2013).
115. Jiao, J. *et al.* Modeling Dravet syndrome using induced pluripotent stem cells (iPSCs) and directly converted neurons. *Hum. Mol. Genet.* **22**, 4241–4252 (2013).
116. Scalise, S. *et al.* Generation of iPSC lines from two patients affected by febrile seizure due to inherited missense mutation in SCN1A gene. *Stem Cell Res.* **49**, 1–4 (2020).
117. Tidball, A. M. *et al.* Variant-specific changes in persistent or resurgent sodium current in SCN8A-related epilepsy patient-derived neurons. *Brain* **143**, 1–16 (2020).
118. Tidball, A. M. *et al.* Rapid Generation of Human Genetic Loss-of-Function iPSC Lines by Simultaneous Reprogramming and Gene Editing. *Stem Cell Reports* **9**, 725–731 (2017).
119. Maltsev, V. A., Rohwedel, J., Hescheler, J. & Wobus, A. M. Embryonic stem cells differentiate in vitro into cardiomyocytes representing sinusnodal, atrial and ventricular cell types. *Mech. Dev.* **44**, 41–50 (1993).

120. Yang, L. *et al.* Human cardiovascular progenitor cells develop from a KDR+ embryonic-stem-cell-derived population. *Nature* **453**, 524–528 (2008).
121. Kattman, S. J. *et al.* Stage-specific optimization of activin/nodal and BMP signaling promotes cardiac differentiation of mouse and human pluripotent stem cell lines. *Cell Stem Cell* **8**, 228–240 (2011).
122. Zhang, J. *et al.* Extracellular Matrix Promotes Highly Efficient Cardiac Differentiation of Human Pluripotent Stem Cells: The Matrix Sandwich Method. *Circ. Res.* **111**, 1125–1136 (2012).
123. Lian, X. *et al.* Directed cardiomyocyte differentiation from human pluripotent stem cells by modulating Wnt/ β -catenin signaling under fully defined conditions. *Nat. Protoc.* **8**, 162–175 (2013).
124. Burridge, P. W. *et al.* Chemically defined generation of human cardiomyocytes. *Nat. Methods* **11**, 855–860 (2014).
125. Lian, X. *et al.* Chemically defined albumin-free human cardiomyocyte generation. *Nat. Methods* **12**, 595–596 (2015).
126. Liang, W., Gasparyan, L., AlQarawi, W. & Davis, D. R. Disease modeling of cardiac arrhythmias using human induced pluripotent stem cells. *Expert Opin. Biol. Ther.* **19**, 313–333 (2019).
127. Fatima, A. *et al.* The disease-specific phenotype in cardiomyocytes derived from induced pluripotent stem cells of two long qt syndrome type 3 patients. *PLoS One* **8**, 1–11 (2013).
128. Ma, D. *et al.* Modeling type 3 long QT syndrome with cardiomyocytes derived from patient-specific induced pluripotent stem cells. *Int. J. Cardiol.* **168**, 5277–5286 (2013).
129. Terrenoire, C. *et al.* Induced pluripotent stem cells used to reveal drug actions in a long QT syndrome family with complex genetics. *J. Gen. Physiol.* **141**, 61–72 (2013).
130. Malan, D. *et al.* Human iPS cell model of type 3 long QT syndrome recapitulates drug-based phenotype correction. *Basic Res. Cardiol.* **111**, 1–11 (2016).
131. Davis, R. P. *et al.* Cardiomyocytes derived from pluripotent stem cells recapitulate electrophysiological characteristics of an overlap syndrome of cardiac sodium channel disease. *Circulation* **125**, 3079–3091 (2012).
132. Veerman, C. C. *et al.* Immaturity of Human Stem-Cell-Derived Cardiomyocytes in Culture: Fatal Flaw or Soluble Problem? *Stem Cells Dev.* **24**, 1–57 (2015).
133. Yang, X., Pabon, L. & Murry, C. E. Engineering Adolescence: Maturation of Human Pluripotent Stem Cell-derived Cardiomyocytes. *Circ. Res.* **114**, 511–523 (2014).
134. Dubois, N. C. *et al.* SIRPA is a specific cell-surface marker for isolating cardiomyocytes derived from human pluripotent stem cells Nicole. *Nat. Biotechnol.* **29**, 1011–1018 (2011).
135. Tohyama, S. *et al.* Distinct metabolic flow enables large-scale purification of mouse and human pluripotent stem cell-derived cardiomyocytes. *Cell Stem Cell* **12**, 127–137 (2013).
136. Sharma, A. *et al.* Derivation of highly purified cardiomyocytes from human induced

- pluripotent stem cells using small molecule-modulated differentiation and subsequent glucose starvation. *J. Vis. Exp.* **2015**, 3–10 (2015).
137. Marban, E., Yamagishi, T. & Tomaselli, G. F. Topical review: structure and function of voltage-gated sodium channel. *J. Physiol.* **508**, 647–657 (1998).
 138. Nerbonne, J. M. & Kass, R. S. Molecular physiology of cardiac repolarization. *Physiol. Rev.* **85**, 1205–1253 (2005).
 139. Marban, E. Cardiac channelopathies. *Nature* **415**, 213–218 (2002).
 140. Keating, M. T.; Sanguinetti, M. C. Molecular and cellular mechanisms of cardiac arrhythmias. *Cell* **104**, 569–580 (2001).
 141. Lane, J. D. & Tinker, A. Have the findings from clinical risk prediction and trials any key messages for safety pharmacology? *Front. Physiol.* **8**, 1–11 (2017).
 142. Periasamy, M. & Kalyanasundaram, A. SERCA pump isoforms: Their role in calcium transport and disease. *Muscle and Nerve* **35**, 430–442 (2007).
 143. Adabag, A. S., Luepker, R. V., Roger, V. L. & Gersh, B. J. Sudden cardiac death: Epidemiology and risk factors. *Nat. Rev. Cardiol.* **7**, 216–225 (2010).
 144. Wong, C. X. *et al.* Epidemiology of Sudden Cardiac Death: Global and Regional Perspectives. *Hear. Lung Circ.* **28**, 6–14 (2019).
 145. Paratz, E. D. *et al.* Cardiac arrest and sudden cardiac death registries: a systematic review of global coverage. *Open Hear.* **7**, 1–10 (2020).
 146. Khan, H. M. & Leslie, S. J. Risk factors for sudden cardiac death to determine high risk patients in specific patient populations that may benefit from a wearable defibrillator. *World J. Cardiol.* **11**, 103–119 (2019).
 147. Hayashi, M., Shimizu, W. & Albert, C. M. The Spectrum of Epidemiology Underlying Sudden Cardiac Death. *Circ. Res.* **116**, 1887–1906 (2015).
 148. Chugh, S. S. *et al.* Epidemiology of Sudden Cardiac Death: Clinical and Research Implications. *Prog Cardiovasc Dis* **51**, 213–228 (2008).
 149. Priori, S. G. *et al.* Task force on sudden cardiac death, European Society of Cardiology: Summary of recommendations. *Europace* **4**, 3–18 (2002).
 150. Deo, R. & Albert, C. M. Epidemiology and genetics of sudden cardiac death. *Circulation* **125**, 620–637 (2012).
 151. Friedlander, Y. *et al.* Family history as a risk factor for primary cardiac arrest. *Circulation* **97**, 155–160 (1998).
 152. Albert, C. M. *et al.* Prospective study of sudden cardiac death among women in the United States. *Circulation* **107**, 2096–2101 (2003).
 153. Zheng, Z. J., Croft, J. B., Giles, W. H. & Mensah, G. A. Sudden cardiac death in the United States, 1989 to 1998. *Circulation* **104**, 2158–2163 (2001).
 154. Moon, R. Y., Horne, R. S. C. & Hauck, F. R. Sudden Infant Death Syndrome. *Lancet* **370**, 1578–1587 (2007).
 155. Tfelt-Hansen, J., Winkel, B. G., Grunnet, M. & Jespersen, T. Cardiac channelopathies

- and sudden infant death syndrome. *Cardiology* **119**, 21–33 (2011).
156. Wong, L. C. H. & Behr, E. R. Sudden unexplained death in infants and children: The role of undiagnosed inherited cardiac conditions. *Europace* **16**, 1706–1713 (2014).
 157. Sarquella-Brugada, G. *et al.* Genetics of sudden cardiac death in children and young athletes. *Cardiol. Young* **23**, 159–173 (2013).
 158. Zipes, D. P. *et al.* ACC/AHA/ESC 2006 guidelines for management of patients with ventricular arrhythmias and the prevention of sudden cardiac death: A report of the American College of Cardiology/American Heart Association Task Force and the European Society of Cardiology Com. *Circulation* vol. 114 (2006).
 159. Gollob, M. H. *et al.* Recommendations for the use of genetic testing in the clinical evaluation of inherited cardiac arrhythmias associated with sudden cardiac death: Canadian cardiovascular society/Canadian heart rhythm society joint position paper. *Can. J. Cardiol.* **27**, 232–245 (2011).
 160. Amin, A. S., Asghari-Roodsari, A. & Tan, H. L. Cardiac sodium channelopathies. *Pflugers Arch. Eur. J. Physiol.* **460**, 223–237 (2010).
 161. Remme, C. A. Cardiac sodium channelopathy associated with SCN5A mutations: Electrophysiological, molecular and genetic aspects. *J. Physiol.* **591**, 4099–4116 (2013).
 162. Hu, D. *et al.* A Mutation in the $\beta 3$ Subunit of the Cardiac Sodium Channel Associated with Brugada ECG Phenotype. **2**, 270–278 (2009).
 163. Brugada, J., Campuzano, O., Arbelo, E., Sarquella-Brugada, G. & Brugada, R. Present Status of Brugada Syndrome: JACC State-of-the-Art Review. *J. Am. Coll. Cardiol.* **72**, 1046–1059 (2018).
 164. Antzelevitch, C. *et al.* Brugada syndrome: A decade of progress. *Circ. Res.* **91**, 1114–1118 (2002).
 165. Brugada, P. & Brugada, J. Right Bundle Branch Block, Persistent ST Segment Elevation and Sudden Cardiac Death: A Distinct Clinical and Electrocardiographic Syndrome. *JACC* **20**, 1391–6 (1992).
 166. Miyazaki, T. *et al.* Autonomic and Antiarrhythmic Drug Modulation of ST Segment Elevation in Patients with Brugada Syndrome. *JACC* **27**, 1061–1070 (1996).
 167. Chen, Q. *et al.* Genetic basis and molecular mechanism for idiopathic ventricular fibrillation. *Nature* **392**, 293–296 (1998).
 168. Kobayashi, T. *et al.* Familial Occurrence of Electrocardiographic Abnormalities of the Brugada-Type. *Intern. Med.* **35**, 637–640 (1996).
 169. Peeters, U. *et al.* Contribution of Cardiac Sodium Channel β -Subunit Variants to Brugada Syndrome. *Circ. J.* **79**, 2118–2129 (2015).
 170. Ma, D. *et al.* Identification of an I_{Na}-dependent and I_{to}-mediated proarrhythmic mechanism in cardiomyocytes derived from pluripotent stem cells of a Brugada syndrome patient. *Sci. Rep.* **8**, 1–11 (2018).
 171. Meregalli, P. G., Wilde, A. A. M. & Tan, H. L. Pathophysiological mechanisms of Brugada syndrome: Depolarization disorder, repolarization disorder, or more?

- Cardiovasc. Res.* **67**, 367–378 (2005).
172. Probst, V. *et al.* Long-term prognosis of patients diagnosed with brugada syndrome: Results from the finger brugada syndrome registry. *Circulation* **121**, 635–643 (2010).
 173. Antzelevitch, C. *et al.* Brugada syndrome: report of the second consensus conference. *Circulation* **2**, 429–440 (2005).
 174. Frustaci, A., Russo, M. A. & Chimenti, C. Structural myocardial abnormalities in asymptomatic family members with Brugada syndrome and SCN5A gene mutation. *Eur. Heart J.* **30**, 1763 (2009).
 175. Catalano, O. *et al.* Magnetic resonance investigations in Brugada syndrome reveal unexpectedly high rate of structural abnormalities. *Eur. Heart J.* **30**, 2241–2248 (2009).
 176. Bayés De Luna, A. *et al.* Current electrocardiographic criteria for diagnosis of Brugada pattern: A consensus report. *J. Electrocardiol.* **45**, 433–442 (2012).
 177. Dumaine, R. *et al.* Ionic mechanisms responsible for the electrocardiographic phenotype of the Brugada syndrome are temperature dependent. *Circ. Res.* **85**, 803–809 (1999).
 178. Brugada, P., Benito, B., Brugada, R. & Brugada, J. Brugada syndrome: Update 2009. *Hell. J. Cardiol.* **50**, 352–372 (2009).
 179. Sarkozy, A. *et al.* Long-term follow-up of primary prophylactic implantable cardioverter-defibrillator therapy in Brugada syndrome. *Eur. Heart J.* **28**, 334–344 (2007).
 180. Nielsen, M. W., Holst, A. G., Olesen, S. P. & Olesen, M. S. The genetic component of brugada syndrome. *Front. Physiol.* **4 JUL**, 1–11 (2013).
 181. Nademanee, K. *et al.* Prevention of ventricular fibrillation episodes in brugada syndrome by catheter ablation over the anterior right ventricular outflow tract epicardium. *Circulation* **123**, 1270–1279 (2011).
 182. Selga, E. *et al.* Comprehensive genetic characterization of a Spanish Brugada syndrome cohort. *PLoS One* **10**, 1–15 (2015).
 183. Tan, B. H., Valdivia, C. R., Song, C. & Makielski, J. C. Partial expression defect for the SCN5A missense mutation G1406R depends on splice variant background Q1077 and rescue by mexiletine. *Am. J. Physiol. - Hear. Circ. Physiol.* **291**, 1822–1828 (2006).
 184. Kapplinger, J. D. *et al.* An international compendium of mutations in the SCN5A-encoded cardiac sodium channel in patients referred for Brugada syndrome genetic testing. *Hear. Rhythm* **7**, 33–46 (2010).
 185. Delpón, E. *et al.* Functional Effects of KCNE3 Mutation and its Role in the Development of Brugada Syndrome. *Circ Arrhythm Electrophysiol.* **1**, 209–218 (2008).
 186. Watanabe, H. *et al.* Sodium channel β 1 subunit mutations associated with Brugada syndrome and cardiac conduction disease in humans. *J. Clin. Invest.* **118**, 2260–2268 (2008).
 187. Hu, D. *et al.* A novel rare variant in SCN1Bb linked to Brugada syndrome and SIDS by combined modulation of Nav1.5 and Kv4.3 channel currents. *Hear. Rhythm* **9**, 760–

- 769 (2012).
188. Riuró, H. *et al.* A Missense Mutation in the Sodium Channel β 2 Subunit Reveals SCN2B as a New Candidate Gene for Brugada Syndrome. *Hum. Mutat.* **34**, 961–966 (2013).
 189. Wan, X., Wang, Q. & Kirsch, G. E. Functional suppression of sodium channels by β 1-subunits as a molecular mechanism of idiopathic ventricular fibrillation. *J. Mol. Cell. Cardiol.* **32**, 1873–1884 (2000).
 190. Hosseini, S. M. *et al.* Reappraisal of reported genes for sudden arrhythmic death: Evidence-based evaluation of gene validity for brugada syndrome. *Circulation* **138**, 1195–1205 (2018).
 191. Di Diego, J. M., Sun, Z. Q. & Antzelevitch, C. I(to) and action potential notch are smaller in left vs. right canine ventricular epicardium. *Am. J. Physiol. - Hear. Circ. Physiol.* **271**, (1996).
 192. Antzelevitch, C. The Brugada syndrome: Diagnostic criteria and cellular mechanisms. *Eur. Heart J.* **22**, 356–363 (2001).
 193. Alings, M. & Wilde, A. “Brugada” Syndrome Clinical Data and Suggested Pathophysiological Mechanism. *Circulation* **99**, 666–673 (1999).
 194. Benito, B., Brugada, J., Brugada, R. & Brugada, P. Brugada syndrome. *Rev Esp Cardiol.* **62**, 1297–1315 (2009).
 195. Bezzina, C. *et al.* A single Na⁺ channel mutation causing both long-QT and Brugada syndromes. *Circ. Res.* **85**, 1206–1213 (1999).
 196. Keller, D. I. *et al.* Brugada syndrome and fever: Genetic and molecular characterization of patients carrying SCN5A mutations. *Cardiovasc. Res.* **67**, 510–519 (2005).
 197. Wan, X., Chen, S., Sadeghpour, A., Wang, Q. & Kirsch, G. E. Accelerated inactivation in a mutant Na⁺ channel associated with idiopathic ventricular fibrillation. *Am. J. Physiol. - Hear. Circ. Physiol.* **280**, 354–360 (2001).
 198. Rook, M. B. *et al.* Human SCN5A gene mutations alter cardiac sodium channel kinetics and are associated with the Brugada syndrome. *Cardiovasc. Res.* **44**, 507–517 (1999).
 199. Veldkamp, M. W. *et al.* Two distinct congenital arrhythmias evoked by a multidysfunctional Na⁽⁺⁾ channel. *Circ. Res.* **86**, 1–7 (2000).
 200. Riuró, H. *et al.* A Missense Mutation in the Sodium Channel β 2 Subunit Reveals SCN2B as a New Candidate Gene for Brugada Syndrome. *Hum. Mutat.* **34**, 961–966 (2013).
 201. London, B. *et al.* Mutation in glycerol-3-phosphate dehydrogenase 1-like gene (GPD1-L) decreases cardiac Na⁺ current and causes inherited arrhythmias. *Circulation* **116**, 2260–2268 (2007).
 202. Liang, P. *et al.* Patient-specific and genome-edited induced pluripotent stem cell-derived cardiomyocytes elucidate single cell phenotype of Brugada Syndrome. *J. Am. Coll. Cardiol.* **68**, 1–22 (2016).
 203. Li, W. *et al.* Disease Phenotypes and Mechanisms of iPSC-Derived Cardiomyocytes From Brugada Syndrome Patients With a Loss-of-Function SCN5A Mutation. *Front. Cell Dev. Biol.* **8**, 1–17 (2020).

204. Kosmidis, G. *et al.* Readthrough-promoting drugs gentamicin and PTC124 Fail to Rescue Nav1.5 function of human-induced pluripotent stem cell-derived cardiomyocytes carrying nonsense mutations in the sodium channel gene SCN5A. *Circ. Arrhythmia Electrophysiol.* **9**, 1–11 (2016).
205. Miller, D. C. *et al.* Ajmaline blocks INa and IKr without eliciting differences between Brugada syndrome patient and control human pluripotent stem cell-derived cardiac clusters. *Stem Cell Res.* **25**, 233–244 (2017).
206. Belbachir, N. *et al.* RRAD mutation causes electrical and cytoskeletal defects in cardiomyocytes derived from a familial case of Brugada syndrome. *Eur. Heart J.* **40**, 3081–3093 (2019).
207. Eldomery, M. K. *et al.* Lessons learned from additional research analyses of unsolved clinical exome cases. *Genome Med.* **9**, 1–15 (2017).
208. Kapplinger, J. D. *et al.* An international compendium of mutations in the SCN5A-encoded cardiac sodium channel in patients referred for Brugada syndrome genetic testing. *Heart Rhythm* **7**, 33–46 (2010).
209. Riuró, H. *et al.* A missense mutation in the sodium channel β 1b subunit reveals SCN1B as a susceptibility gene underlying long QT syndrome. *Heart Rhythm* **11**, 1202–1209 (2014).
210. Lin, Y. *et al.* Heparin Promotes Cardiac Differentiation of Human Pluripotent Stem Cells in Chemically Defined Albumin-Free Medium, Enabling Consistent Manufacture of Cardiomyocytes. *Stemcells Transl. Med.* **5**, 1–12 (2016).
211. Parikh, S. S. *et al.* Thyroid and Glucocorticoid Hormones Promote Functional T-Tubule Development in Human-Induced Pluripotent Stem Cell-Derived Cardiomyocytes. *Circ. Res.* **121**, 1323–1330 (2017).
212. Taylor, S. C., Berkelman, T., Yadav, G. & Hammond, M. A defined methodology for reliable quantification of western blot data. *Mol. Biotechnol.* **55**, 217–226 (2013).
213. Taylor, S. C. & Posch, A. The design of a quantitative western blot experiment. *Biomed Res. Int.* **2014**, (2014).
214. Xu, X. Q. *et al.* Chemically defined medium supporting cardiomyocyte differentiation of human embryonic stem cells. *Differentiation* **76**, 958–970 (2008).
215. Zanella, F. & Sheikh, F. Patient-specific induced pluripotent stem cell models: Generation and characterization of cardiac cells. *Methods Mol. Biol.* (2014) doi:10.1007/7651_2014_172.
216. Matsumura, H. *et al.* H558R, a common SCN5A polymorphism, modifies the clinical phenotype of Brugada syndrome by modulating DNA methylation of SCN5A promoters. *J. Biomed. Sci.* **24**, 1–10 (2017).
217. Martinez-Moreno, R. *et al.* An SCN1B Variant Affects Both Cardiac-Type (Nav1.5) and Brain-Type (Nav1.1) Sodium Currents and Contributes to Complex Concomitant Brain and Cardiac Disorders. *Front. Cell Dev. Biol.* **8**, (2020).
218. Qu, Y. *et al.* Modulation of cardiac Na⁺ channel expression in *Xenopus* oocytes by β 1 subunits. *J. Biol. Chem.* **270**, 25696–25701 (1995).

219. Ko, S. H., Lenkowski, P. W., Lee, H. C., Mounsey, J. P. & Patel, M. K. Modulation of Nav1.5 by β 1- and β 3-subunit co-expression in mammalian cells. *Pflugers Arch. Eur. J. Physiol.* **449**, 403–412 (2005).
220. Yuan, L. *et al.* Investigations of the Nav β 1b sodium channel subunit in human ventricle; functional characterization of the H162P Brugada syndrome mutant. *Am. J. Physiol. - Hear. Circ. Physiol.* **306**, 1204–1212 (2014).
221. Fahmi, A. I. *et al.* The sodium channel β -subunits SCN3b modulates the kinetics of SCN5a and is expressed heterogeneously in sheep heart. *J. Physiol.* **537**, 693–700 (2001).
222. Isom, L. L. *et al.* Primary structure and functional expression of the β 1 subunit of the rat brain sodium channel. *Science (80-.).* **256**, 839–842 (1992).
223. Aman, T. K. *et al.* Regulation of persistent Na current by interactions between β subunits of voltage-gated Na channels. *J. Neurosci.* **29**, 2027–2042 (2009).
224. Audenaert, D. *et al.* A deletion in SCN1B is associated with febrile seizures and early-onset absence epilepsy. *Neurology* **61**, 854–856 (2003).
225. Tan, B. H. *et al.* Sudden infant death syndrome-associated mutations in the sodium channel beta subunits. *Hear. Rhythm* **7**, 771–778 (2010).
226. Ricci, M. T. *et al.* SCN1B gene variants in Brugada syndrome: A study of 145 SCN5A-negative patients. *Sci. Rep.* **4**, 4–9 (2014).
227. Kruger, L. C. *et al.* β 1-C121W is down but not out: Epilepsy-associated scn1b-C121W results in a deleterious gain-of-function. *J. Neurosci.* **36**, 6213–6224 (2016).
228. Symonds, J. D. & Zuberi, S. M. Genetics update: Monogenetics, polygene disorders and the quest for modifying genes. *Neuropharmacology* **132**, 3–19 (2018).
229. Thiffault, I. *et al.* Recessive mutations in POLR1C cause a leukodystrophy by impairing biogenesis of RNA polymerase III. *Nat. Commun.* **6**, 1–9 (2015).
230. Clatot, J. *et al.* Voltage-gated sodium channels assemble and gate as dimers. *Nat. Commun.* **8**, 1–14 (2017).
231. Herskowitz, I. Functional inactivation of genes by dominant negative mutations. *Nature* **329**, 219–222 (1987).
232. Sottas, V. & Abriel, H. Negative-dominance phenomenon with genetic variants of the cardiac sodium channel Nav1.5. *Biochim. Biophys. Acta - Mol. Cell Res.* **1863**, 1–22 (2016).
233. Clatot, J. *et al.* Dominant-negative effect of SCN5A N-terminal mutations through the interaction of Nav1.5 α -subunits. *Cardiovasc. Res.* **96**, 53–63 (2012).
234. Clatot, J. *et al.* Mutant voltage-gated Na⁺ channels can exert a dominant negative effect through coupled gating. *Am. J. Physiol. - Hear. Circ. Physiol.* **315**, H1250–H1257 (2018).
235. Mercier, A. *et al.* The β 1-Subunit of Nav1.5 Cardiac Sodium Channel Is Required for a Dominant Negative Effect through α - α Interaction. *PLoS One* **7**, 5–12 (2012).
236. Núñez, L. *et al.* p.D1690N Nav1.5 rescues p.G1748D mutation gating defects in a

- compound heterozygous Brugada syndrome patient. *Hear. Rhythm* **10**, 264–272 (2013).
237. Lizotte, E. *et al.* Genetic modulation of brugada syndrome by a common polymorphism. *J. Cardiovasc. Electrophysiol.* **20**, 1137–1141 (2009).
238. Viswanathan, P. C., Benson, D. W. & Balser, J. R. A common SCN5A polymorphism modulates the biophysical effects of an SCN5A mutation. *J. Clin. Invest.* **111**, 341–346 (2003).
239. Poelzing, S. *et al.* SCN5A polymorphism restores trafficking of a Brugada syndrome mutation on a separate gene. *Circulation* **114**, 368–376 (2006).
240. Shinlapawittayatorn, K. *et al.* A common SCN5A polymorphism modulates the biophysical defects of SCN5A mutations. *Hear. Rhythm* **8**, 455–462 (2011).
241. Marangoni, S. *et al.* A Brugada syndrome mutation (p.S216L) and its modulation by p.H558R polymorphism: Standard and dynamic characterization. *Cardiovasc. Res.* **91**, 606–616 (2011).
242. Antzelevitch, C. *et al.* Loss-of-Function Mutations in the Cardiac Calcium Channel Underlie a New Clinical Entity Characterized by ST-Segment Elevation, Short QT Intervals, and Sudden Cardiac Death. *Circulation* **115**, 442–449 (2007).
243. Hu, D. *et al.* Dual variation in SCN5A and CACNB2b underlies the development of cardiac conduction disease without Brugada syndrome. *Pacing Clin. Electrophysiol.* **33**, 274–285 (2010).
244. Antzelevitch, C. & Fish, J. M. Therapy for the brugada syndrome. *Handb. Exp. Pharmacol.* **171**, 305–330 (2006).
245. Garcia, S. *et al.* Hypertrophic Cardiomyopathy: A Review. *Soc. Bras. Cardiol.* 927–935 (2020).
246. Cirino, A. L. & Ho, C. Hypertrophic Cardiomyopathy Overview. *GeneReviews*[®] 1–16.
247. Campuzano, O., Fernández-Falgueras, A., Iglesias, A. & Brugada, R. Brugada Syndrome and PKP2: Evidences and uncertainties. *Int. J. Cardiol.* **214**, 1–9 (2016).
248. Corrado, D. *et al.* Right Bundle Branch Block, Right Precordial ST-Segment Elevation, and Sudden Death in Young People. *Circulation* **103**, 710–717 (2001).
249. Cerrone, M. *et al.* Missense Mutations in Plakophilin-2 Cause Sodium Current Deficit and Associate with a Brugada Syndrome Phenotype. *Circulation* **129**, 1092–1103 (2014).
250. Cerrone, M. *et al.* Sodium current deficit and arrhythmogenesis in a murine model of plakophilin-2 haploinsufficiency. *Cardiovasc. Res.* **95**, 460–468 (2012).
251. Lee, H.-C. H. & Ching, C.-K. Practical Aspects in Genetic Testing for Cardiomyopathies and Channelopathies. *Clin. Biochem. Rev.* **40**, 187–200 (2019).
252. Coll, M. *et al.* Incomplete penetrance and variable expressivity: Hallmarks in channelopathies associated with sudden cardiac death. *Biology (Basel)*. **7**, 1–10 (2018).
253. Campuzano, O. *et al.* Update on genetic basis of Brugada syndrome: Monogenic,

polygenic or oligogenic? *Int. J. Mol. Sci.* **21**, 1–10 (2020).

Annex

Annex Contents

Annex Contents	191
Annex Figures	193
Annex Tables	195
Annex	199
1. Cellular electricity.....	199
1.1. Electrical properties of plasma membranes	199
1.1.1. Ohm’s law.....	199
1.1.2. The Nernst equation	201
1.1.3. Membrane potential	203
1.2. Cellular current recordings	204
1.2.1. Voltage clamp.....	205
2. Primers and probes used in the qPCR experiments	209
3. Generation of iPS cell lines.....	210
4. Clone characterization	212
5. Cardiomyocyte characterization	216
6. Electrophysiological characterization of iPS-CM	219
7. Study of the genetic background with a panel of genes related to cardiac arrhythmias....	222
Annex Bibliography	227

Annex Figures

Figure 1. Schematic representation of an electrical RC circuit.	201
Figure 2. Na ⁺ predicted current voltage relationship.	203
Figure 3. Schematic representation of an electrical circuit of an axon membrane, presented by Hodgkin and Huxley.	204
Figure 4. Simplified schematic voltage clamp circuit.	206
Figure 5. Patch clamp recording configurations.	207
Figure 6. iPSc colonies showing Alkaline phosphatase staining (left) and karyotype (right) of Rb20234 C17 iPSc (top), Rb202236 C21 iPSc (middle) and Rb20237 C5 iPSc (bottom).	212
Figure 7. Pluripotency characterization of Rb20235 C5 iPSc clone.	213
Figure 8. Pluripotency characterization of Rb20236 C21 iPSc clone.	214
Figure 9. Pluripotency characterization of Rb20236 C21 iPSc clone.	215

Annex Tables

Table 1. Properties of the ions involved in cardiac electrophysiology at 37 °C and a V_m of -80 mV.	199
Table 2. Sequence, amplicon length and efficiency of the primers for the qPCR experiments using the KAPA SYBR FAST qPCR Kit.....	209
Table 3. Probe code, amplicon length and exon boundary of the probes used for the qPCR experiments using the TaqMan® Gene Expression Assays.....	209
Table 4. Expression levels of the pluripotency transcription factors obtained by relative quantification (Rq) of the GPG1 iPSc, compared with the GPG1 fibroblasts.	210
Table 5. Expression levels of the pluripotency transcription factors obtained by relative quantification (Rq) of the discarded clones for the individual Rb20234, compared with the non-related control GPG1 iPSc.	210
Table 6. Expression levels of the pluripotency transcription factors obtained by relative quantification (Rq) of the discarded clones for the individual Rb20235, compared with the non-related control GPG1 iPSc.	211
Table 7. Expression levels of the pluripotency transcription factors obtained by relative quantification (Rq) of the discarded clones for the individual Rb20236, compared with the non-related control GPG1 iPSc.	211
Table 8. Expression levels of the pluripotency transcription factors obtained by relative quantification (Rq) of the discarded clones for the individual Rb20237, compared with the non-related control GPG1 iPSc.	211
Table 9. Expression levels of the pluripotency transcription factors obtained by relative quantification (Rq) of three iPSc-CM differentiation rounds for the two selected clones from individual Rb20234, compared with their respective iPSc.	216
Table 10. Expression levels of the pluripotency transcription factors obtained by relative quantification (Rq) of three iPSc-CM differentiation rounds for the two selected clones from individual Rb20235, compared with their respective iPSc.	216

Table 11. Expression levels of the pluripotency transcription factors obtained by relative quantification (Rq) of three iPS-CM differentiation rounds for the two selected clones from individual Rb20236, compared with their respective iPSc.	216
Table 12. Expression levels of the pluripotency transcription factors obtained by relative quantification (Rq) of three iPS-CM differentiation rounds for the two selected clones from individual Rb20237, compared with their respective iPSc.	217
Table 13. Expression levels of the cardiac markers obtained by relative quantification (Rq) of three iPS-CM differentiation rounds for the two selected clones from individual Rb20234, compared with their respective iPSc.	217
Table 14. Expression levels of the cardiac markers obtained by relative quantification (Rq) of three iPS-CM differentiation rounds for the two selected clones from individual Rb20235, compared with their respective iPSc.	217
Table 15. Expression levels of the cardiac markers obtained by relative quantification (Rq) of three iPS-CM differentiation rounds for the two selected clones from individual Rb20236, compared with their respective iPSc.	218
Table 16. Expression levels of the cardiac markers obtained by relative quantification (Rq) of three iPS-CM differentiation rounds for the two selected clones from individual Rb20237, compared with their respective iPSc.	218
Table 17. Expression levels of the ventricular and auricular markers obtained by relative quantification (Rq) of five iPS-CM differentiation rounds for each individual and the individual Rq mean, normalized by the nodal marker HCN4 and compared with Rb20237.	219
Table 18. Biophysical parameters of Rb20234 C5 and Rb20234 C17 iPS-CM and pooled data.	219
Table 19. Biophysical parameters of Rb20235 C5 and Rb20235 C39 iPS-CM and pooled data.	220
Table 20. Biophysical parameters of Rb20236 C21 and Rb20236 C24 iPS-CM and pooled data.	220
Table 21. Expression levels of SCN5A obtained by relative quantification (Rq) of five iPS-CM differentiation rounds for each individual and the individual Rq mean, compared with Rb20237.	221
Table 22. Common variants in structural genes identified in the four members of the family.....	222

Table 23. Common variants in non-structural genes identified in the four members of the family.....	223
Table 24. Common variants in structural genes identified in the four members of the family.....	224
Table 25. Common variants in non-structural genes identified in the four members of the family.....	225

1. Cellular electricity

The cell membrane is a lipid bilayer formed by extracellular, intracellular and transcellular proteins associated. It is hydrophobic, impermeable to large molecules such as proteins and nucleic acids, and selectively permeable to ions. One of the ways ions can flow through the membrane is thanks to one kind of transmembrane proteins: the ion channels.¹⁻³

The known functions of ion channels include establishing a resting membrane potential and shaping electrical signals, among several others. The importance of ions in cell excitability has been known since 1881. Sidney Ringer demonstrated that the perfusion solution for a frog heart must contain Na^+ , K^+ and Ca^{2+} ions, if the heart was to continue beating for long.² K^+ concentration is higher in the intracellular than in the extracellular compartment. On the contrary, Na^+ and Ca^{2+} concentrations are higher in the extracellular than in the intracellular compartment (**Table 1**).³ In 1902, Julius Bernstein proposed that the membrane of excitable cells is selectively permeable to K^+ ions at rest, and the permeability to other ions increases during excitation. He explained the resting potential of the membrane as a diffusion potential set up by the tendency of positively charged ions to diffuse from a high concentration in the cytoplasm to a low concentration in the extracellular solution. Upon excitation, the internal negativity is lost transiently as more ions diffuse across the membrane.²

Table 1. Properties of the ions involved in cardiac electrophysiology at 37 °C and a V_m of -80 mV.

Ion	Extracellular concentration $[\text{X}]_o$ (mM)	Intracellular concentration $[\text{X}]_i$ (mM)	$[\text{X}]_o/[\text{X}]_i$	Equilibrium potential E_x (mV)	Driving force ($V_m - E_x$)
Na^+	145	15	9.6667	+61	-141
K^+	4.5	120	0.0375	-88	+8
Ca^{2+}	1.2	10^{-4}	$12 \cdot 10^3$	+125	-205
Cl^-	116	20	5.8	-47	-33

1.1. Electrical properties of plasma membranes

1.1.1. Ohm's law

Most cellular plasma membranes are electrically polarized due to a transmembrane voltage, or membrane potential.³ In 1827, Georg Ohm established the most important electrical law: Ohm's law. It describes a relation between current, voltage and conductance.² A few concepts are necessary to understand that law.

Atoms are made up of charged particles. Most bodies are neutral, because charged particles are normally present in equal quantities: one mole of hydrogen atom contains an Avogadro's number ($N = 6.02 \cdot 10^{23}$) of protons and the same number of electrons. The charge quantity is measured in coulombs (C), and the elementary charge of a proton is $q_e = 1.6 \cdot 10^{-19} \text{ C}$.²

The charge on a mole of protons is named the Faraday constant:²

$$F = N \cdot q_e = 6.02 \cdot 10^{23} \times 1.6 \cdot 10^{-19} \approx 10^5 \text{ C/mol}$$

The flow of charges is called a current (I), and arise when charges of opposite sign are separated or can move independently.² Current is measured in amperes (A), and corresponds to a steady flow of 1 C/s. Benjamin Franklin established that positive current flows in the movement direction of positive charges.² Michael Faraday proposed the terminology of ions, anions and cations. When anions flow towards the positive pole and cations to the negative, both carry electric current towards the negative pole.² The size of the current can be determined by two factors²:

- The **potential difference (V)** between the electrodes: Is measured in volts (V). The work needed to move 1 C of charge between two points is 1 V.
- The **electrical conductance (G)**: Is measured in siemens (S) and is defined as the ease of flow of current between two points.

Ohm's law states that current I equals the product of the conductance G and voltage V difference across the conductor:

$$I = G \cdot V$$

Ion channels can be seen as ion conductors, while the membrane bilayer is a poor conductor with a high resistance (R, measured in ohms (Ω)) to electrical current, reciprocal to G. According to Ohm's law, V and I are related by R:^{2,3}

$$R = \frac{V}{I}$$

Biological membranes can be seen as electrical capacitors, as the insulating lipid bilayer separates internal and external conducting solutions and charges. In a charged capacitor, one of the sides bears a charge of +Q and the other side -Q. Said capacitor maintains a potential difference between both sides. The capacitance (C) is measured in farad (F = coulomb/volt), and it is defined as how much charge needs to be transferred between two conductors to set up a potential difference²:

$$C = \frac{Q}{V}$$

Membranes and ion channels can be represented as an electrical RC circuit (**Figure 1**). If the switch of said circuit remains open, the capacitor maintains the charge. When the switch is closed, the capacitor is discharged through a resistor and the voltage difference in the circuit between the points “in” and “out” decays from V_0 to 0.³

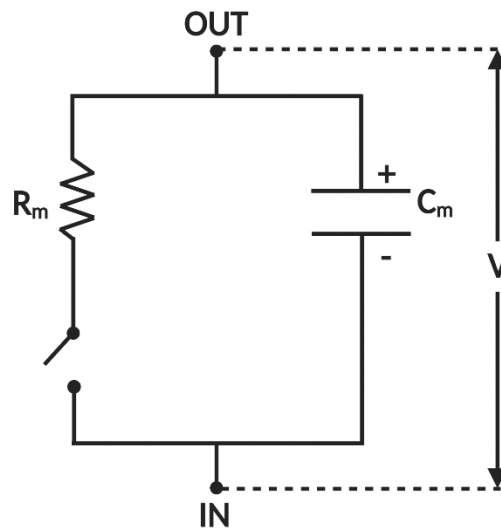

Figure 1. Schematic representation of an electrical RC circuit.

The decay time for the voltage to fall to 37% of the initial value is known as the time constant (τ):³

$$\tau = R_m \cdot C_m$$

And the time constant in voltage units is:

$$V = V_0 \cdot e^{-t/R \cdot C}$$

Although electrical circuits are well suited to represent the properties of membranes and ion channels, a modification in Ohm’s law must be included as the current through the ion channels (or conductors) do not reach a value of 0 mV.²

1.1.2. The Nernst equation

Walther Nernst worked in 1888 on electrical potentials arising from the diffusion of electrolytes in solution.² The driving force of an ion is defined as the electrochemical potential energy difference across the membrane, and determines the flow of ions. This electrochemical potential energy includes a contribution of the concentration gradient

of the solute, and any difference in voltage between the two cellular compartments (inside (i) and outside (o)). For an ion X, it is defined as:³

$$\Delta\mu_X = RT \ln \frac{[X]_i}{[X]_o} + z_X F (\Psi_i - \Psi_o)$$

Where $\Delta\mu_X$ is the net driving force of X, R is the gas constant, T is absolute temperature, $[X]_i$ and $[X]_o$ is the ion concentration inside and outside the cell, z_X is the valence and F the Faraday's constant. $\Psi_i - \Psi_o$ is the voltage difference across the membrane, known as membrane potential (V_m). The first term on the right side of the equation is the difference in chemical potential energy, and describes the energy change in J/mole as X moves across the membrane. The second term is the electrical potential energy difference, and describes the energy change of a mole of charged particles when it moves across the membrane.³

If no net driving force is acting on an ion, that ion is said to be at equilibrium across the membrane ($\Delta\mu_X = 0$), also known as steady state. The net driving force of an ion $\Delta\mu_X$ (J/mole) is more commonly defined in voltage (mV) as $(V_m - E_X)$.³ All systems are moving towards equilibrium, and the previous equation can be rearranged in the following way:

$$V_m = E_X = -\frac{RT}{z_X F} \ln \frac{[X]_i}{[X]_o}$$

This is the Nernst equation, and describes the conditions when an ion is in equilibrium across the membrane. E_X is the equilibrium potential of ion X, also known as Nernst potential. It can be considered as the membrane voltage needed for an ion X to be in equilibrium.³ Ionic equilibrium potentials vary linearly with the absolute temperature, and logarithmically with the ion concentration ratio. The sign of the equilibrium potential will be determined by the charge of the ion and the driving force. When V_m is more negative than E_X , the current is negative or inward; when V_m is more positive than E_X , the current is positive or outwards.^{2,3}

The equilibrium potential follows two principles. Taking Na^+ ions as an example:²

- If the membrane pores are only permeable to Na^+ ions, these ions will move towards its equilibrium potential and the membrane potential will change to E_{Na} .
- If the membrane potential is held at E_{Na} , there will not be a flux of Na^+ ions.

Going back to the Na^+ example, the current will be inward if V_m is more negative than E_{Na} . If the voltages are more positive than E_{Na} , the current will then go in an outward direction (**Figure 2**).

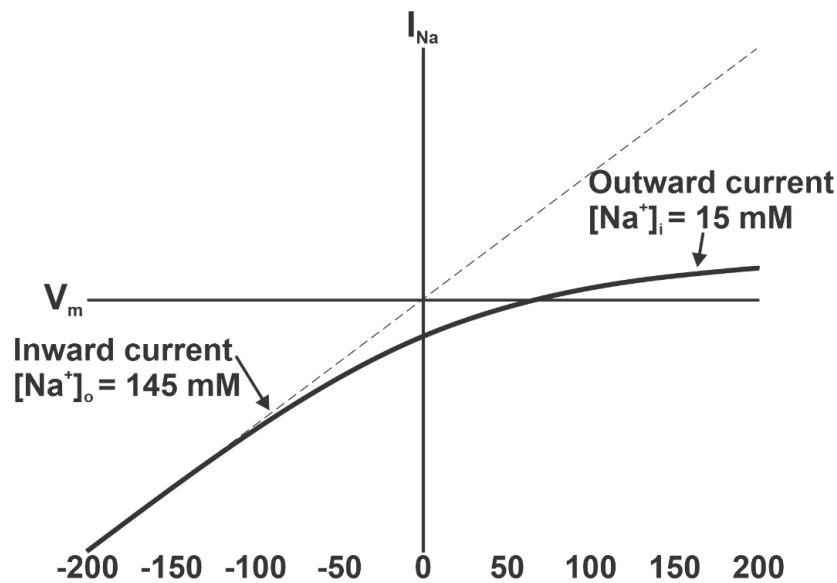

Figure 2. Na^+ predicted current voltage relationship.

1.1.3. Membrane potential

The equilibrium potential of an ion also predicts the reversal potential (V_{rev}) for that ion, that is the voltage where the direction of the current reverses.³ The Goldman-Hodgkin-Katz (GHK) voltage equation calculates V_{rev} . It is a modified Nernst equation which includes ion permeability ratios (P):

$$V_{\text{rev}} = \frac{RT}{F} \ln \frac{P_A[A]_o + P_B[B]_o}{P_A[A]_i + P_B[B]_i}$$

Equilibrium potentials and other properties of the ions in normal physiological conditions involved in cardiac electrophysiology are listed in **Table 2**.³

- The driving force for Na^+ ($V_m - E_{\text{Na}}$) at normal membrane resting potential is strongly negative, thus it favors the passive movement of Na^+ ions into every cell of the body. Voltage-gated Na^+ channels (Na_v) are responsible for starting the action potential in many excitable cells.
- The driving force for K^+ ($V_m - E_{\text{K}}$) at normal membrane resting potential is close to 0 or positive, thus K^+ ions are either at equilibrium or tends to move outward the cell. K^+ channels play a major role in generating a resting membrane voltage that is

inside-negative. These channels also participate in the cell membrane repolarization, which terminates the action potential.

- The driving force for Ca^{2+} ($V_m - E_{\text{Ca}}$) at normal membrane resting potential is strongly negative, thus Ca^{2+} ions tend to move inward the cell. Ca^{2+} channels play a vital role in transmembrane signaling in both nonexcitable and excitable cells, and in generating action potentials.³

With Walther Nernst findings, Hodgkin and Huxley modified the Ohm's law including the driving force of ion X as the term $V_m - E_X$:^{2,3}

$$I_X = G_X \cdot (V_m - E_X)$$

1.2. Cellular current recordings

The ionic theory of membrane excitation explained throughout this chapter was proved by Alan Hodgkin, Andrew Huxley and Bernard Katz between 1935 and 1952. They studied the passive membrane properties and the AP propagation in the squid giant axon.² Hodgkin and Huxley recognized three different components of current in their work with the squid giant axon in 1952, which they called: sodium, potassium and leakage. This leakage current, was defined as a small and voltage-independent background conductance.²

Hodgkin and Huxley used a modified version of Ohm's law to explain the electrical model of the membrane, by introducing ionic conductances. They also modified the circuit representation to include their recently discovered current components (**Figure 3**).²

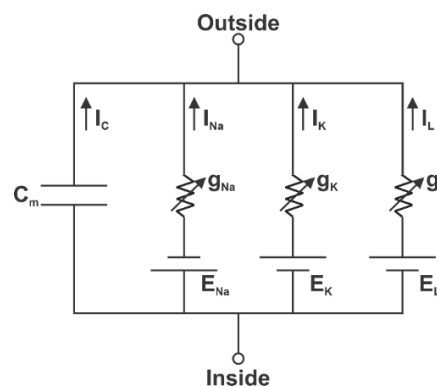

Figure 3. Schematic representation of an electrical circuit of an axon membrane, presented by Hodgkin and Huxley. C_m represents the capacitive dielectric properties of the cell membrane. g refers to the ions (Na, K) and leak (L) conductances, I to their currents, and E to their electromotive forces. The resistors with arrows through them denote time- and voltage-varying conductances. Adapted from Hille.²

The membrane potential E_M , is defined as the inside potential minus the outside. Usually the outside medium is considered to be at ground potential of 0 mV, and thus E_M is simply the intracellular potential.² E_M is measured with glass micropipette electrodes (or microelectrodes) made with capillary tubing, and filled with a salt solution whose composition depends on the experimental protocol. The capillary containing a silver chloride wire electrode was connected to an amplifier. This system allowed to measure potentials in the region outside the electrode tip.^{2,4} The microelectrode has to be mechanically stable to avoid drift with respect to the cell that could damage the membrane and produce leak. This drift can arise from the cell moving in the preparation, or the microelectrode moving in its holder.⁴

Ion channel properties can be studied in the laboratory with different techniques. The current or the voltage of a cell can be changed to a fixed value (clamped) for a constant time, to be returned to the original value again. This is known as a square pulse:^{3,4}

- **Current clamp:** If the current is clamped injecting a current pulse, the voltage will change in response with a time constant τ as previously seen in section 6.1.1.
- **Voltage clamp:** To voltage clamp means to control the voltage across the cell membrane as a means to measure the electrical current that results from the flow of ions.^{2,4} If the voltage is clamped injecting a voltage pulse, the current will change. A transient capacitive current I_C appears (Figure) as charge flows onto the capacitor, being maximal at the beginning of the pulse. This current then falls exponentially with a time constant τ . When voltage reaches its original value, I_C flows in the opposite direction: I_C is represented as brief spikes at the beginning and end of the pulse. When the voltage applied is constant, this I_C is zero.

1.2.1. Voltage clamp

To control the voltage across the cell membrane, the current needed to keep a constant potential is supplied even when the membrane permeability changes. To readjust the current, a feedback amplifier with a good high-frequency response is used.² A schematic voltage clamp circuit is represented in **Figure 4**. In this circuit, V_m is the membrane potential measured by the voltage follower. The clamping amplifier with a gain A , compares V_m with the command potential E to pass current through the access

resistance R_a (given by the cytoplasmic resistance) to control V_m . R_s represents a resistance in series with the membrane and the electrodes. This resistance leads to a discrepancy between the clamping amplifier membrane potential V_m and the true potential across the membrane. This R_s can be compensated by adding a voltage signal proportional to the membrane current.⁴

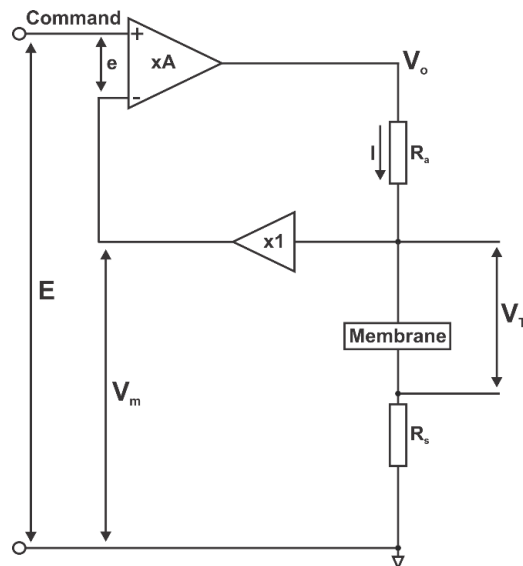

Figure 4. Simplified schematic voltage clamp circuit. Adapted from Ogden.⁴

Much of what we know about ion channel properties in cell membranes comes from experiments using voltage clamp. This method was developed by Cole in 1949, and Hodgkin and Huxley in 1952 using the squid giant axon as a model.⁴ Another big step in electrophysiology came with the development of the gigaseal and patch clamp methods.² In 1976, Neher and Sakmann reported the first record from a tiny area (or patch) of the membrane obtained by pressing a fire-polished pipette.⁵ Five years later, Hamill *et al.* showed that clean glass pipettes could fuse with cell membranes to form a high resistance seal with mechanical stability. This seal was called a gigaseal because it could have an electrical resistance of tens of gigaohms.⁶

This gigaseal is needed for two reasons. First, the higher the resistance, the more electrical isolation of the membrane patch. And second, a high seal resistance reduces the current noise of the recording.⁴

The discovery of the gigaseal permitted four new electrical recording configurations (**Figure 5**):^{2,4}

- **On-cell or cell-attached patch:** As soon as the pipette is sealed to the membrane, single channels can be recorded.
- **Inside-out or excised patch:** If the seal is stable, the patch can be pulled off the cell by being still sealed to the pipette and single channels can be recorded.
- **Outside-out patch:** It results from pulling the pipette away from the cell in the whole-cell configuration, allowing the recording of single channels.
- **Whole-cell:** In the on-cell configuration, the patch can be suctioned and thus ruptured with the pipette still sealed to the cell. The contents of the pipette solution alter the composition of the cytoplasm, and thus is a valuable tool for cell biological and biochemical studies.

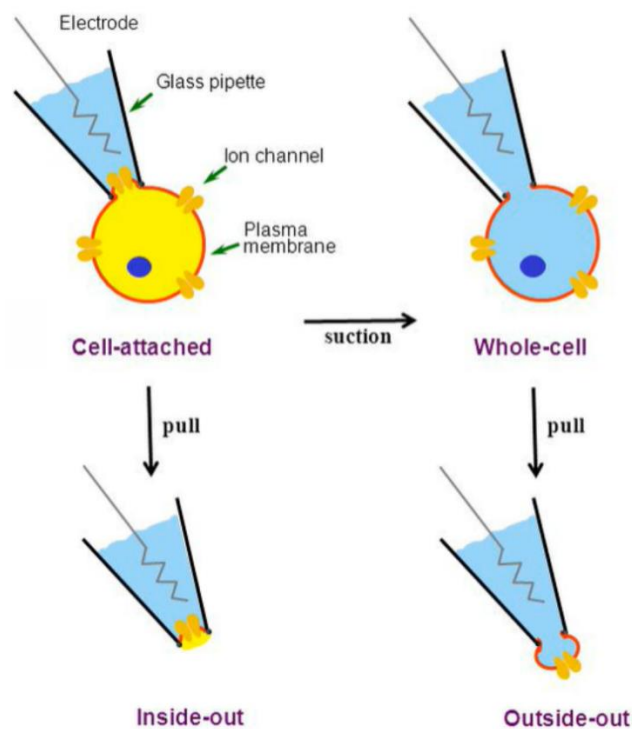

Figure 5. Patch clamp recording configurations. Adapted from Biophysics 702 Patch Clamp Techniques, by Stuart Mangel (<https://slideplayer.com/slide/3334202/>).

When a whole-cell experiment involves a change in membrane potential, the macroscopic currents recorded represent the sum of the ions flowing through many channels and of different types. To study a particular ion channel, this macroscopic

current has to be separated into its constituent components. For that, several methods (alone or in combination) are used:⁴

- **Time of measurement:** The currents can be separated if their kinetics are sufficiently different, by using a suitable time during a voltage clamp pulse.
- **Ionic substitution:** If it is possible to perfuse the inside of the cell, it can be applied to intracellular and extracellular substitutions. In the whole cell patch clamp technique, this method is widely used.
- **Pharmacological separation:** Different substances that block ion channels are used. These blockers can range from simple inorganic ions to synthetic drugs, to complex natural toxins. They can act from the inside as well the outside of the cell. Sometimes this method is used in combination with ionic substitution.
- **Voltage pulse protocol:** This method is suitable when the activation and inactivation of different channels occurs over different membrane potential ranges.
- **Channel expression:** In cell types that have little or no intrinsic ion conductance like *Xenopus* oocytes and HEK cells, a particular channel can be cloned and expressed. The main disadvantage of this method is that the cloned channel may not exactly reflect its behavior in the native cell, due to the lack of certain regulatory proteins.

2. Primers and probes used in the qPCR experiments

Table 2. Sequence, amplicon length and efficiency of the primers for the qPCR experiments using the KAPA SYBR FAST qPCR Kit.

Gene	Sequence	Amplicon (bp)	Efficiency (%)
<i>GAPDH</i>	FW: CTGCACCACCAACTGCTTAG RV: GAGGCAGGGATGATGTTCTGG	177	99.1
Nanog	FW: GACAAGGTCCCGGTCAAGAA RV: CTGAGGTTTCAGGATGTTGGA	140	103.1
Sox-2	FW: AGTCCGAGGCCAGCTCCA RV: TAGTGCTGGGACATGTGAAGTC	160	98.7
Oct-4	FW: CCCGCCGTATGAGTTCTGTG RV: CATCGGAGTTGCTCTCCACC	134	96.3
<i>MYBPC3</i>	FW: CCATCTGAGTACGAGCGCAT RV: GCCCTTGAGCCTCTTTAGCA	75	106.98
<i>TNNI3</i>	FW: CCTCCAACCTACCGCGTTAT RV: CTGCAATTTTCTCGAGGCGG	77	108.57
<i>SCN5A</i>	FW: CGAGGCCAGTGCATCTCAGG RV: GTATCACCTTCCACTCTGTCCA	125	101.2

Table 3. Probe code, amplicon length and exon boundary of the probes used for the qPCR experiments using the TaqMan® Gene Expression Assays.

Gene	Probe code	Amplicon (bp)	Exon boundary
<i>PPIA</i>	Hs04194521_s1	97	6
18S	Hs99999901_s1	187	1
<i>MYL2</i>	Hs00166405_m1	98	6 - 7
<i>MYL7</i>	Hs01085598_g1	74	4 - 5
<i>HCN4</i>	Hs04982536_s1	96	1

3. Generation of iPSc cell lines

Table 4. Expression levels of the pluripotency transcription factors obtained by relative quantification (Rq) of the GPG1 iPSc, compared with the GPG1 fibroblasts.

Sample	GPG1								
	Nanog			Sox-2			Oct-4		
	Rq	Rq min	Rq max	Rq	Rq min	Rq max	Rq	Rq min	Rq max
Fibroblasts	1	0.64	1.57	1	0.87	1.15	1	0.93	1.08
iPSc	652.68	632.85	673.14	19335.55	18965.88	19721.78	1953.92	1899.32	2010.09

Table 5. Expression levels of the pluripotency transcription factors obtained by relative quantification (Rq) of the discarded clones for the individual Rb20234, compared with the non-related control GPG1 iPSc.

Clones	Rb20234 iPSc								
	Nanog			Sox-2			Oct-4		
	Rq	Rq min	Rq max	Rq	Rq min	Rq max	Rq	Rq min	Rq max
C16	3.913	3.747	4.091	4.710	4.569	8.857	1.014	0.980	1.048
C18	3.713	3.416	4.038	2.747	2.541	2.971	1.393	1.284	1.511
C22	3.233	2.937	3.595	4.491	3.672	5.534	0.853	0.802	0.917
C26	3.164	1.972	5.576	4.760	3.214	7.373	0.593	0.488	0.795
C30	1.891	1.796	1.991	1.604	1.401	1.862	1.465	1.391	1.545
C31	1.070	0.991	1.157	1.129	1.039	1.229	0.728	0.686	0.775
C34	1.804	1.717	1.895	1.520	1.453	1.592	0.757	0.719	0.797
C41	3.193	3.051	3.343	1.925	1.840	2.014	0.893	0.863	0.925
C46	1.717	1.633	1.806	2.159	2.092	2.228	0.657	0.631	0.684
C49	1.158	1.095	1.227	2.277	2.186	2.374	0.487	0.450	0.528
C54	1.573	1.475	1.679	1.860	1.795	1.927	0.611	0.566	0.661

Table 6. Expression levels of the pluripotency transcription factors obtained by relative quantification (Rq) of the discarded clones for the individual Rb20235, compared with the non-related control GPG1 iPSc.

Rb20235 iPSc									
Clones	Nanog			Sox-2			Oct-4		
	Rq	Rq min	Rq max	Rq	Rq min	Rq max	Rq	Rq min	Rq max
C1	6.278	3.722	11.258	7.762	6.639	9.156	1.268	1.102	1.461
C26	1.023	0.981	1.066	2.257	2.135	2.386	0.344	0.326	0.363
C40	0.357	0.339	0.377	0.962	0.928	0.997	0.255	0.239	0.272

Table 7. Expression levels of the pluripotency transcription factors obtained by relative quantification (Rq) of the discarded clones for the individual Rb20236, compared with the non-related control GPG1 iPSc.

Rb20236 iPSc									
Clones	Nanog			Sox-2			Oct-4		
	Rq	Rq min	Rq max	Rq	Rq min	Rq max	Rq	Rq min	Rq max
C8	0.983	0.937	1.032	1.043	1.003	1.084	1.142	1.023	1.279
C9	1.505	1.449	1.562	1.008	0.955	1.065	0.655	0.634	0.677
C25	12.485	10.438	14.982	2.032	1.846	2.241	4.289	3.981	4.622
C29	2.605	2.497	2.717	0.609	0.588	0.631	1.122	1.069	1.178
C32	1.908	1.787	2.039	0.686	0.672	0.700	0.914	0.879	0.951

Table 8. Expression levels of the pluripotency transcription factors obtained by relative quantification (Rq) of the discarded clones for the individual Rb20237, compared with the non-related control GPG1 iPSc.

Rb20237 iPSc									
Clones	Nanog			Sox-2			Oct-4		
	Rq	Rq min	Rq max	Rq	Rq min	Rq max	Rq	Rq min	Rq max
C1	0.820	0.751	0.908	0.511	0.454	0.582	0.222	0.197	0.257
C3	1.118	0.817	1.673	0.604	0.552	0.662	0.236	0.172	0.376
C4	1.790	1.562	2.093	0.535	0.452	0.633	0.253	0.253	0.253
C6	1.113	0.973	1.279	0.869	0.763	0.991	0.199	0.169	0.237

4. Clone characterization

Rb20234 C17 iPSc

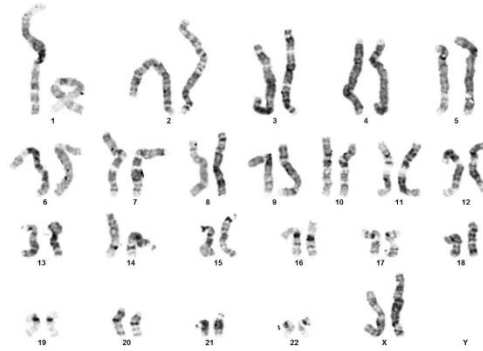
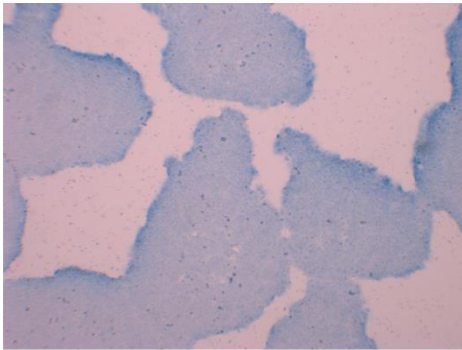

Rb20236 C21 iPSc

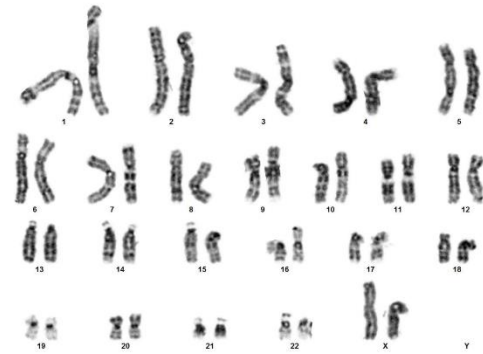
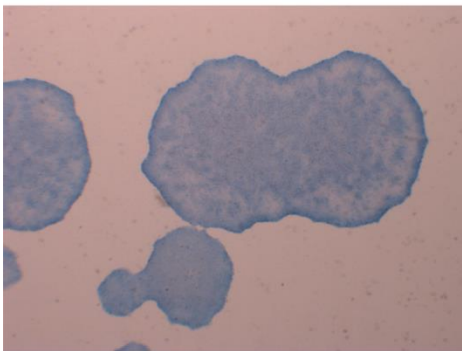

Rb20237 C5 iPSc

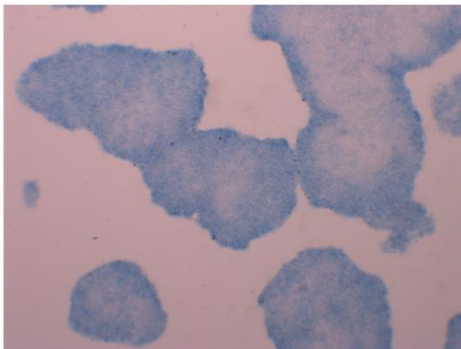

Figure 6. iPSc colonies showing Alkaline phosphatase staining (left) and karyotype (right) of Rb20234 C17 iPSc (top), Rb202236 C21 iPSc (middle) and Rb20237 C5 iPSc (bottom).

Rb20235 C5 iPSc

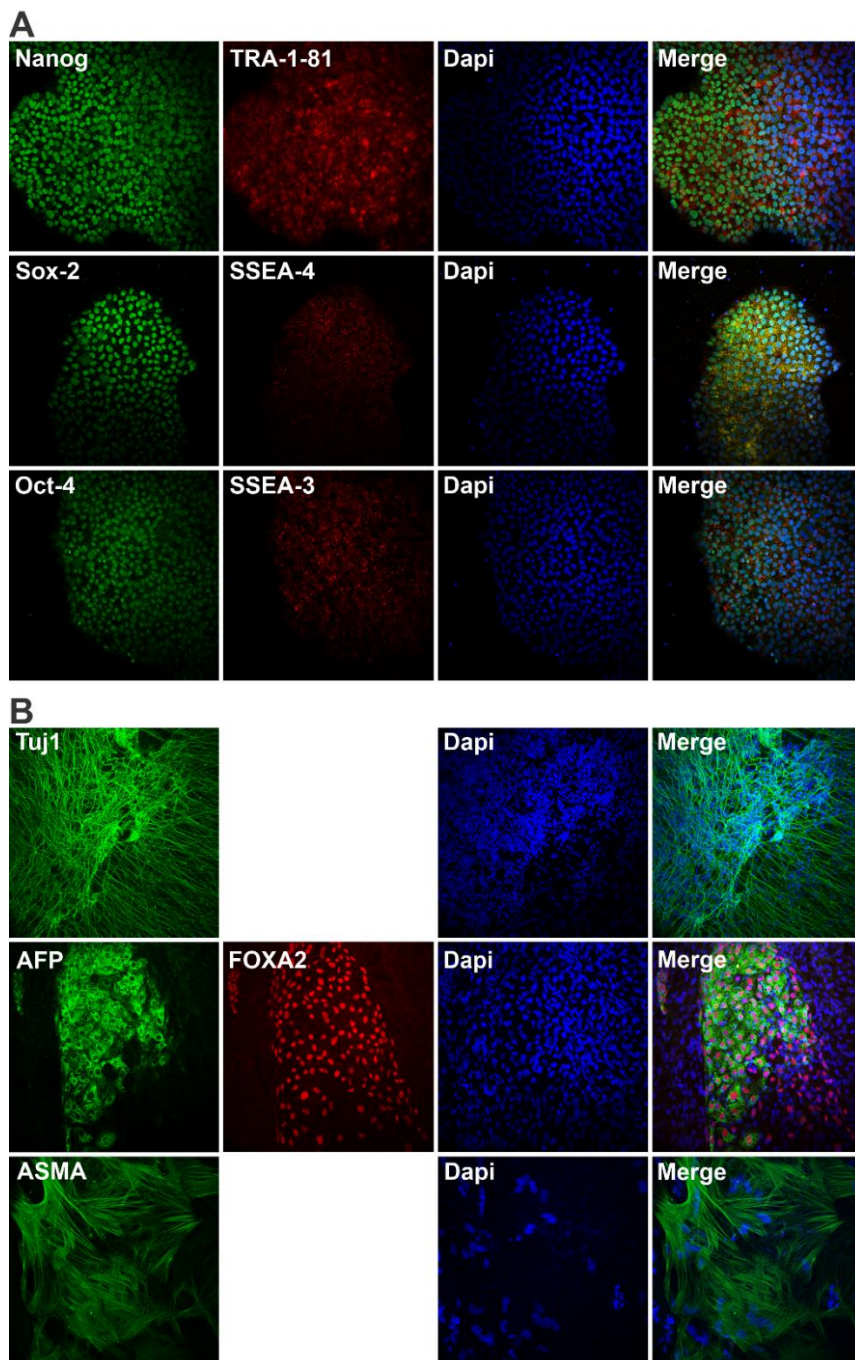

Figure 7. Pluripotency characterization of Rb20235 C5 iPSc clone. (A) iPSc clone Rb20235 C5 tested positive for pluripotency markers Nanog and TRA-1-81 (upper panel), Sox-2 and SSEA-4 (middle panel), and Oct-4 and SSEA-3 (bottom panel). **(B)** Studies of in vitro differentiation to cells of the 3 germ layers showed the capacity of the studied iPSc to differentiate into cells of the ectoderm (positive staining for Tuj1, upper panel), endoderm (positive staining for AFP and FOXA2, middle panel), and mesoderm (positive staining for ASMA, bottom panel).

Rb20236 C21 iPSc

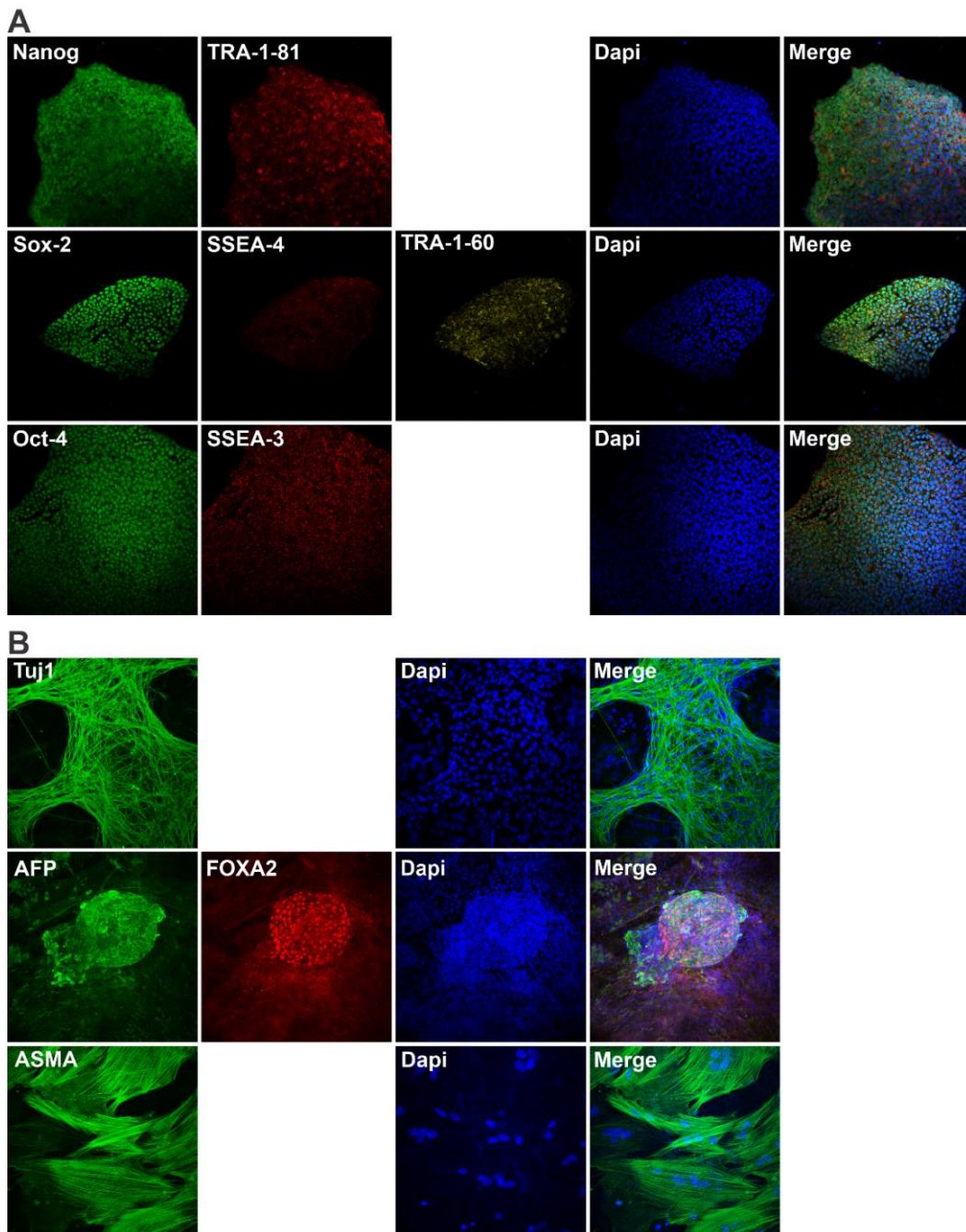

Figure 8. Pluripotency characterization of Rb20236 C21 iPSc clone. (A) iPSc clone Rb20236 C21 tested positive for pluripotency markers Nanog and TRA-1-81 (upper panel), Sox-2, SSEA-4 and TRA-1-60 (middle panel), and Oct-4 and SSEA-3 (bottom panel). **(B)** Studies of in vitro differentiation to cells of the 3 germ layers showed the capacity of the studied iPSc to differentiate into cells of the ectoderm (positive staining for Tuj1, upper panel), endoderm (positive staining for AFP and FOXA2, middle panel), and mesoderm (positive staining for ASMA, bottom panel).

Rb20237 C5 iPSc

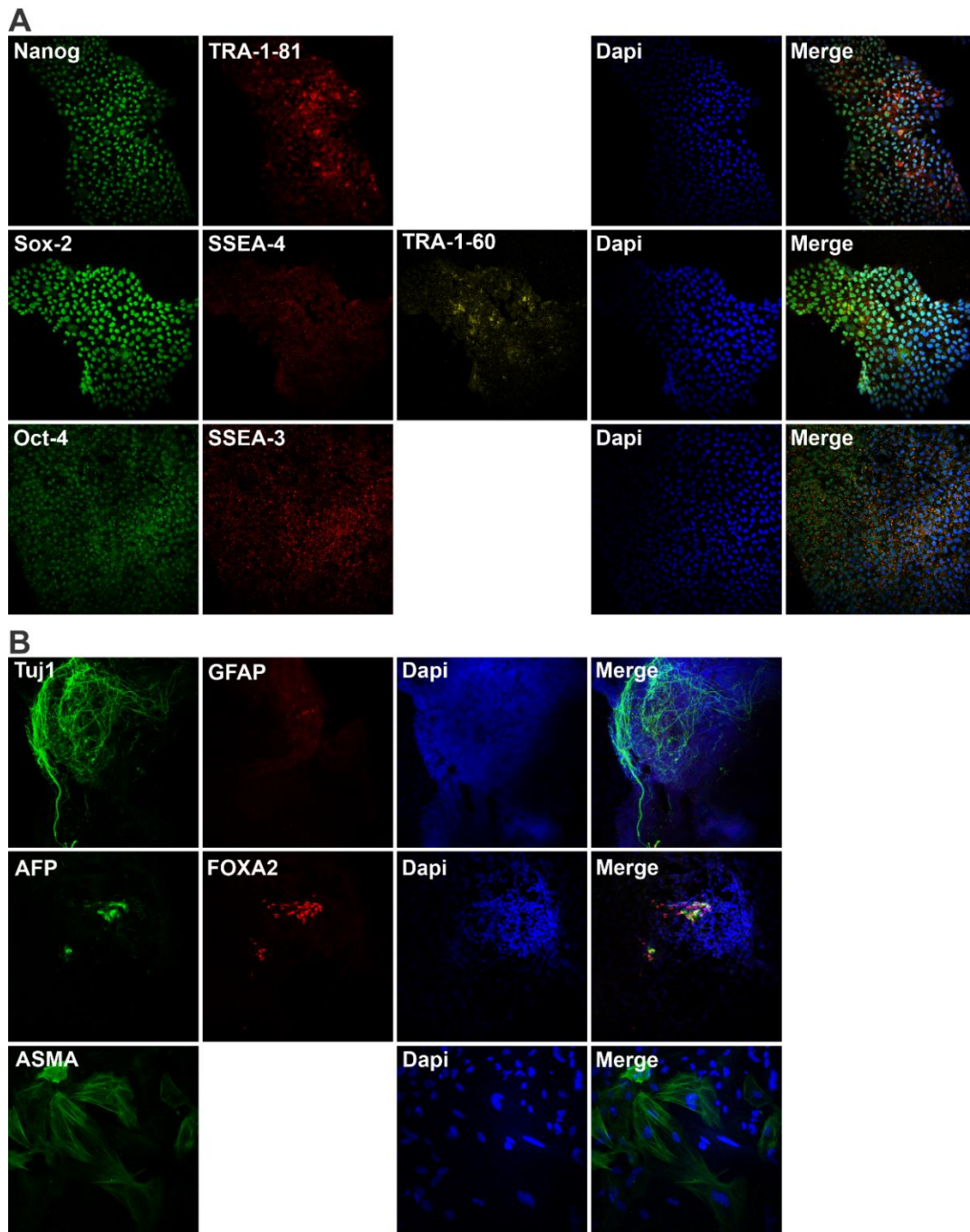

Figure 9. Pluripotency characterization of Rb20236 C21 iPSc clone. (A) iPSc clone Rb20236 C21 tested positive for pluripotency markers Nanog and TRA-1-81 (upper panel), Sox-2, SSEA-4 and TRA-1-60 (middle panel), and Oct-4 and SSEA-3 (bottom panel). **(B)** Studies of in vitro differentiation to cells of the 3 germ layers showed the capacity of the studied iPSc to differentiate into cells of the ectoderm (positive staining for Tuj1 and GFAP, upper panel), endoderm (positive staining for AFP and FOXA2, middle panel), and mesoderm (positive staining for ASMA, bottom panel).

5. Cardiomyocyte characterization

Table 9. Expression levels of the pluripotency transcription factors obtained by relative quantification (Rq) of three iPS-CM differentiation rounds for the two selected clones from individual Rb20234, compared with their respective iPSc.

Rb20234 iPS-CM										
Clone	Round	Nanog			Sox-2			Oct-4		
		Rq	Rq min	Rq max	Rq	Rq min	Rq max	Rq	Rq min	Rq max
C5	R15	0.013	0.011	0.014	0.013	0.012	0.015	0.009	0.008	0.009
	R18	0.017	0.016	0.019	0.003	0.003	0.004	0.005	0.005	0.005
	R20	0.035	0.031	0.04	0.003	0.002	0.003	0.004	0.003	0.004
C17	R7	0.172	0.162	0.182	0.016	0.014	0.018	0.030	0.028	0.033
	R10	0.156	0.146	0.167	0.024	0.023	0.026	0.037	0.030	0.046
	R12	0.005	0.003	0.008	0.001	0.000	0.001	0.001	0.001	0.002

Table 10. Expression levels of the pluripotency transcription factors obtained by relative quantification (Rq) of three iPS-CM differentiation rounds for the two selected clones from individual Rb20235, compared with their respective iPSc.

Rb20235 iPS-CM										
Clone	Round	Nanog			Sox-2			Oct-4		
		Rq	Rq min	Rq max	Rq	Rq min	Rq max	Rq	Rq min	Rq max
C5	R7	0.001	0.001	0.002	0.000	0.000	0.000	0.000	0.000	0.000
	R8	0.022	0.020	0.023	0.004	0.004	0.004	0.003	0.003	0.004
	R11	0.021	0.017	0.025	0.002	0.002	0.002	0.002	0.002	0.003
C39	R6	0.016	0.014	0.018	0.001	0.001	0.002	0.003	0.003	0.004
	R8	0.010	0.008	0.013	0.001	0.001	0.002	0.002	0.002	0.002
	R9	0.006	0.004	0.008	0.000	0.000	0.000	0.001	0.001	0.002

Table 11. Expression levels of the pluripotency transcription factors obtained by relative quantification (Rq) of three iPS-CM differentiation rounds for the two selected clones from individual Rb20236, compared with their respective iPSc.

Rb20236 iPS-CM										
Clone	Round	Nanog			Sox-2			Oct-4		
		Rq	Rq min	Rq max	Rq	Rq min	Rq max	Rq	Rq min	Rq max
C21	R1	0.005	0.004	0.006	0.003	0.003	0.003	0.002	0.002	0.003
	R2	0.005	0.005	0.006	0.003	0.002	0.003	0.004	0.004	0.004
	R5	0.016	0.015	0.017	0.002	0.002	0.002	0.003	0.003	0.003
C24	R3	0.006	0.005	0.007	0.002	0.001	0.002	0.003	0.003	0.003
	R4	0.011	0.011	0.012	0.005	0.004	0.006	0.006	0.005	0.006
	R12	0.006	0.004	0.009	0.002	0.001	0.002	0.003	0.002	0.004

Table 12. Expression levels of the pluripotency transcription factors obtained by relative quantification (Rq) of three iPS-CM differentiation rounds for the two selected clones from individual Rb20237, compared with their respective iPSc.

Rb20237 iPS-CM										
Clone	Round	Nanog			Sox-2			Oct-4		
		Rq	Rq min	Rq max	Rq	Rq min	Rq max	Rq	Rq min	Rq max
C2	R1	0.006	0.006	0.007	0.002	0.002	0.002	0.002	0.002	0.002
	R2	0.008	0.006	0.011	0.001	0.001	0.002	0.003	0.002	0.003
	R4	0.010	0.009	0.011	0.004	0.004	0.004	0.002	0.002	0.003
C5	R4	0.010	0.010	0.011	0.001	0.001	0.001	0.008	0.007	0.008
	R6	0.013	0.012	0.015	0.002	0.002	0.002	0.013	0.011	0.014
	R8	0.051	0.045	0.057	0.007	0.007	0.008	0.010	0.010	0.011

Table 13. Expression levels of the cardiac markers obtained by relative quantification (Rq) of three iPS-CM differentiation rounds for the two selected clones from individual Rb20234, compared with their respective iPSc.

Rb20234 iPS-CM										
Clone	Round	MYBPC3			TNNT3			SCN5A		
		Rq	Rq min	Rq max	Rq	Rq min	Rq max	Rq	Rq min	Rq max
C5	R15	217578.7	199624.8	237147.2	3233.4	2965.6	3525.5	301.7	279.1	326.1
	R18	392975.5	373007.8	414012.1	1898.8	1801.0	2001.9	363.0	345.1	381.8
	R20	47325.8	42136.3	53154.3	1503.1	1376.4	1641.3	53.1	40.9	68.9
C17	R7	1502394.4	1413491.2	1596889.2	1139.6	1076.3	1206.6	1768.1	1662.4	1880.7
	R10	334468.7	312329.7	358176.9	3777.3	3519.4	4054.0	105.4	93.7	119.7
	R12	42897.9	39121.6	470038.7	457.9	408.5	513.3	19.3	17.1	21.8

Table 14. Expression levels of the cardiac markers obtained by relative quantification (Rq) of three iPS-CM differentiation rounds for the two selected clones from individual Rb20235, compared with their respective iPSc.

Rb20235 iPS-CM										
Clone	Round	MYBPC3			TNNT3			SCN5A		
		Rq	Rq min	Rq max	Rq	Rq min	Rq max	Rq	Rq min	Rq max
C5	R7	2154.5	1937.6	2375.6	3160.5	2850.9	3503.7	47.2	42.4	52.6
	R8	6915.5	6693.2	7145.3	928.5	890.3	968.4	5.1	4.9	5.3
	R11	25148.9	23904.1	26458.5	3627.5	3424.2	3842.8	50.7	48.2	53.3
C39	R6	57276.2	55176.3	59456	1225.7	1176.2	1277.4	38.3	36.8	39.8
	R8	66876.4	63054.9	70929.5	13603.5	12833.2	14419.9	93.1	87.4	99.2
	R9	43392.7	41569.9	45295.5	594.5	573.7	616.1	33.4	32.2	34.6

Table 15. Expression levels of the cardiac markers obtained by relative quantification (Rq) of three iPS-CM differentiation rounds for the two selected clones from individual Rb20236, compared with their respective iPSc.

Rb20236 iPS-CM										
Clone	Round	MYBPC3			TNNI3			SCN5A		
		Rq	Rq min	Rq max	Rq	Rq min	Rq max	Rq	Rq min	Rq max
C21	R1	157631.9	149.940.2	165718.1	3549.5	3331.4	3781.9	61.9	59	64.9
	R2	220772.6	218617.7	222948.8	5105.7	4999.4	5214.2	12.5	12.3	12.8
	R5	48714.3	47179.4	50299.2	2060.6	2019.1	2103	11.2	10.8	11.7
C24	R3	10429.4	9971.6	10908.2	803.4	768.2	840.2	19.3	18.6	20.1
	R4	53341.9	51547.7	55198.7	3915.4	3757.4	4080.1	123.5	119.2	127.9
	R12	32845.3	26467.7	40759.7	2684.7	2135.4	3375.2	116.9	84.5	161.8

Table 16. Expression levels of the cardiac markers obtained by relative quantification (Rq) of three iPS-CM differentiation rounds for the two selected clones from individual Rb20237, compared with their respective iPSc.

Rb20237 iPS-CM										
Clone	Round	MYBPC3			TNNI3			SCN5A		
		Rq	Rq min	Rq max	Rq	Rq min	Rq max	Rq	Rq min	Rq max
C2	R1	1248.9	1193.9	1306.5	100.1	96.0	104.4	8.5	7.8	9.2
	R2	4149.5	3961.8	4345.9	232.5	222.7	242.7	32.1	30.1	34.1
	R4	7427.0	7044.6	7830.2	1404.0	1327.9	1484.5	42.6	40.1	45.2
C5	R4	14867.2	13169.2	16784.2	352.2	330.6	375.2	7.6	6.9	8.4
	R6	24849.2	22458.3	27494.6	318.1	287.9	351.5	13.9	12.5	15.4
	R8	3225.5	3013.5	3452.5	178.2	166.1	191.1	2.3	2.1	2.5

6. Electrophysiological characterization of iPS-CM

Table 17. Expression levels of the ventricular and auricular markers obtained by relative quantification (Rq) of five iPS-CM differentiation rounds for each individual and the individual Rq mean, normalized by the nodal marker HCN4 and compared with Rb20237.

Individual	Clone	Round	MYL2	MYL2 mean	MYL7	MYL7 mean
			Rq±SEM	Rq±SEM	Rq±SEM	Rq±SEM
Rb20234	C5	R18	2.84±1.20	2.41±0.41	2.75±1.08	2.20±0.39
		R20	1.95±0.69		1.74±0.69	
	C17	R7	3.66±1.17		3.09±1.22	
		R10	1.51±0.52		1.33±0.52	
		R12	2.12±0.93		2.08±0.82	
Rb20235	C5	R8	1.39±0.46	3.32±0.76	1.20±0.47	2.63±0.67
		R11	2.52±0.97		2.11±0.97	
	C39	R6	3.48±1.14		2.98±1.17	
		R8	8.42±2.38		6.22±2.45	
		R9	0.79±0.24		0.64±0.25	
Rb20236	C21	R1	2.01±0.65	3.15±0.51	1.71±0.68	2.51±0.46
		R2	2.84±1.04		2.57±1.01	
		R5	5.65±1.61		3.94±1.56	
	C24	R3	1.89±0.56		1.52±0.60	
		R12	3.38±1.06		2.82±1.11	

Table 18. Biophysical parameters of Rb20234 C5 and Rb20234 C17 iPS-CM and pooled data.

Parameter	Rb20234 C5	Rb20234 C17	Pooled Rb20234
Peak I_{Na} density			
pA/pF	-19.72±2.63	-26.52±5.29	-22.96±2.90
n	11	10	21
Activation			
V _{1/2} (mV)	-33.16±1.75	-35.19±1.76	-34.09±1.23
k	5.25±0.31	4.29±0.35	4.81±0.25
n	12	10	22
Steady-state inactivation			
V _{1/2} (mV)	-53.89±1.40	-54.73±1.43	-54.66±0.99
k	7.70±0.32	8.07±0.64	7.46±0.29
n	10	8	18
Recovery from inactivation			
τ (ms)	6.29±1.32	7.12±1.24	6.68±0.88
n	7	6	13

Table 19. Biophysical parameters of Rb20235 C5 and Rb20235 C39 iPS-CM and pooled data.

Parameter	Rb20235 C5	Rb20235 C39	Pooled Rb20235
Peak I_{Na} density			
pA/pF	-21.46±5.48	-26.82±9.85	-22.53±4.72
n	16	4	20
Activation			
$V_{1/2}$ (mV)	-29.71±1.51	-32.12±1.97	-30.33±1.23
k	5.27±0.41	3.92±0.35	4.92±0.34
n	15	4	19
Steady-state inactivation			
$V_{1/2}$ (mV)	-56.45±1.67	-51.52±2.40	-55.14±1.46
k	6.59±0.81	5.32±0.75	6.25±0.65
n	11	4	15
Recovery from inactivation			
τ (ms)	4.44±0.71	5.76±1.68	4.79±0.67
n	11	4	15

Table 20. Biophysical parameters of Rb20236 C21 and Rb20236 C24 iPS-CM and pooled data.

Parameter	Rb20236 C21	Rb20236 C24	Pooled Rb20236
Peak I_{Na} density			
pA/pF	-176.98±20.28	-170.64±30.81	-173.55±18.73
n	11	13	24
Activation			
$V_{1/2}$ (mV)	-38.23±1.87	-41.35±1.57	-40.10±1.22
k	3.48±0.45	4.42±0.56	4.04±0.39
n	8	12	20
Steady-state inactivation			
$V_{1/2}$ (mV)	-60.09±1.32	-60.86±2.44	-60.34±1.16
k	6.98±0.62	7.58±0.88	7.18±0.50
n	12	6	18
Recovery from inactivation			
τ (ms)	4.58±0.62	3.98±0.75	4.37±0.47
n	11	6	17

Table 21. Expression levels of *SCN5A* obtained by relative quantification (Rq) of five iPS-CM differentiation rounds for each individual and the individual Rq mean, compared with Rb20237.

Individual	Clone	Round	<i>SCN5A</i>	<i>SCN5A</i> mean
			Rq±SEM	Rq±SEM
Rb20234	C5	R18	0.16±0.05	2.15±0.60
		R20	2.28±0.68	
	C17	R7	6.45±1.92	
		R10	0.48±0.14	
		R12	1.38±0.41	
Rb20235	C5	R8	0.61±0.18	1.60±0.30
		R11	2.09±0.62	
	C39	R6	1.49±0.44	
		R8	3.19±0.95	
		R9	0.63±0.19	
Rb20236	C21	R1	1.25±0.37	2.26±0.50
		R2	1.32±0.40	
		R5	0.35±0.10	
	C24	R3	3.34±0.99	
		R12	5.12±1.53	

7. Study of the genetic background with a panel of genes related to cardiac arrhythmias

Table 22. Common variants in structural genes identified in the four members of the family.

Gene	Variant
<i>ACTN2</i>	c.877-8C>G
<i>AKAP9</i>	c.1389G>T
	c.4004_4006dup
	c.6945+8C>T
	c.8375A>G
	c.8935C>T
<i>CRYAB</i>	c.324+4T>G
<i>DMD</i>	c.8810G>A
	c.2645A>G
<i>DSP</i>	c.2631G>A
<i>JUP</i>	c.2089A>T
<i>NEBL</i>	c.1671+9T>C
	c.1008+5A>G
<i>NEXN</i>	c.733G>A
<i>PDLIM3</i>	c.906C>T
<i>RBM20</i>	c.2303G>C
	c.3452-9G>C
	c.3667G>C
<i>TNNI3</i>	c.373-10T>G
<i>TNNT2</i>	c.53-11_53-7del
<i>TRDN</i>	c.1313T>G
	c.1188A>G
	c.601C>G
	c.383C>G
<i>TTN</i>	c.93062-10del
	c.59542G>C
	c.10256G>A
	c.9781G>A
	c.4480+6C>T
	c.3884C>T
	c.3601A>G

Table 23. Common variants in non-structural genes identified in the four members of the family.

Gene	Variant
<i>ABCC9</i>	c.1165-6del
<i>BAG3</i>	c.451T>C
<i>CASQ2</i>	c.420+6T>C
	c.738-5del
<i>KCNE1</i>	c.112A>G
<i>KCNJ5</i>	c.844C>G
<i>RYR2</i>	c.13783-6A>G
<i>SCN10A</i>	c.5137A>G
<i>TGFBR2</i>	c.263+7A>G

Table 24. Common variants in structural genes identified in the four members of the family. Green filled cells indicate the individual as carrier of the SNV.

Gene	Variant	Rb20234	Rb20235	Rb20236	Rb20237
<i>DMPK</i>	c.611+6T>C				
<i>DSC2</i>	c.2393G>A				
<i>DSG2</i>	c.2137G>A				
	c.2318G>A				
	c.523+24del				
	c.877A>G				
<i>DSP</i>	c.5213G>A				
<i>FBN1</i>	c.3464-5G>A				
	c.1415G>A				
<i>JPH2</i>	c.1186G>A				
<i>LMNA</i>	c.1698C>T				
<i>MYBPC3</i>	c.472G>A				
	c.706A>G				
<i>MYH6</i>	c.3979-8del				
	c.3302T>C				
	c.3979-7_3979-5dup				
<i>MYH7</i>	c.3337-3_3337-1dup				
	c.732C>T				
<i>MYPN</i>	c.1884C>G				
	c.2072G>A				
	c.2120G>A				
	c.2409C>G				
	c.3403C>A				
<i>PKP2</i>	c.1097T>C				
<i>RBM20</i>	c.1527+8C>T				
<i>TMPO</i>	c.1079+5dup				
<i>TNNI3</i>	c.25-8T>A				
<i>TRDN</i>	c.1805-7del				
	c.1805-7_1805-5dup				
	c.1105+5G>A				
<i>TRIM63</i>	c.709A>G				
<i>TTN</i>	c.55319C>T				
	c.35254A>G				
	c.26951-3del				
	c.19054G>C				
	c.2432C>T				

Table 25. Common variants in non-structural genes identified in the four members of the family.

Green filled cells indicate the individual as carrier of the SNV.

Gene	Variant	Rb20234	Rb20235	Rb20236	Rb20237
<i>ABCC9</i>	c.4450-5del				
	c.574-5C>A				
<i>BAG3</i>	c.1220C>T				
<i>CACNA2D1</i>	c.1516-10del				
	c.659-3del				
	c.355-5_355-3dup				
<i>CACNB2</i>	c.1803T>G				
<i>FKTN</i>	c.608G>A				
	c.166C>T				
<i>KCNH2</i>	c.2690A>C				
<i>KCNJ5</i>	c.938-10G>A				
<i>RYR2</i>	c.849-8T>C				
<i>SCN10A</i>	c.3275T>C				
	c.3218T>C				
	c.2884A>G				
	c.1868-9A>G				
<i>SCN1B</i>	c.629T>C				
<i>SCN5A</i>	c.1673A>G				
	c.1141-3C>A				
<i>SLMAP</i>	c.1341C>T				
<i>TGFBR2</i>	c.455-4T>A				

Annex Bibliography

1. Bezanilla, F. Ion Channels: From Conductance to Structure. *Neuron* **60**, 456–468 (2008).
2. Hille, B. *Ion Channels of Excitable Membranes*. (Sinauer associates, Inc, 2001). doi:10.1007/3-540-29623-9_5640.
3. Boron, W. F. & Boulpaep, E. L. *Medical Physiology. A cellular and molecular approach* (Saunders Elsevier, 2012). doi:10.1017/CBO9781107415324.004.
4. Ogden, D. *Microelectrode Techniques: The Plymouth Workshop Handbook*. (The Company of Biologists Limited, 1994).
5. Neher, E. & Sakmann, B. Single-channel currents recorded from membrane of denervated frog muscle fibres. *Nature* **260**, 799–802 (1976).
6. Hamill, O. P., Marty, A., Neher, E., Sakmann, B. & Sigworth, F. J. Improved patch-clamp techniques for high-resolution current recording from cells and cell-free membrane patches. *Pflügers Arch. Eur. J. Physiol.* **391**, 85–100 (1981).

